



Algorithms

FOURTH EDITION

ROBERT SEDGEWICK | KEVIN WAYNE

Algorithms

FOURTH EDITION

This page intentionally left blank

Algorithms

FOURTH EDITION

Robert Sedgewick
and
Kevin Wayne

Princeton University

◆◆ Addison-Wesley

Upper Saddle River, NJ • Boston • Indianapolis • San Francisco
New York • Toronto • Montreal • London • Munich • Paris • Madrid
Capetown • Sydney • Tokyo • Singapore • Mexico City

Many of the designations used by manufacturers and sellers to distinguish their products are claimed as trademarks. Where those designations appear in this book, and the publisher was aware of a trademark claim, the designations have been printed with initial capital letters or in all capitals.

The authors and publisher have taken care in the preparation of this book, but make no expressed or implied warranty of any kind and assume no responsibility for errors or omissions. No liability is assumed for incidental or consequential damages in connection with or arising out of the use of the information or programs contained herein.

The publisher offers excellent discounts on this book when ordered in quantity for bulk purchases or special sales, which may include electronic versions and/or custom covers and content particular to your business, training goals, marketing focus, and branding interests. For more information, please contact:

U.S. Corporate and Government Sales
(800) 382-3419
corpsales@pearsontechgroup.com

For sales outside the United States, please contact:

International Sales
international@pearson.com

Visit us on the Web: informit.com/aw

Cataloging-in-Publication Data is on file with the Library of Congress.

Copyright © 2011 Pearson Education, Inc.

All rights reserved. Printed in the United States of America. This publication is protected by copyright, and permission must be obtained from the publisher prior to any prohibited reproduction, storage in a retrieval system, or transmission in any form or by any means, electronic, mechanical, photocopying, recording, or likewise. For information regarding permissions, write to:

Pearson Education, Inc.
Rights and Contracts Department
501 Boylston Street, Suite 900
Boston, MA 02116
Fax: (617) 671-3447

ISBN-13: 978-0-321-57351-3

ISBN-10: 0-321-57351-X

Text printed in the United States on recycled paper at Courier in Westford, Massachusetts.

First printing, March 2011

*To Adam, Andrew, Brett, Robbie
and especially Linda*

To Jackie and Alex

CONTENTS

<i>Preface</i>	<i>viii</i>
1 Fundamentals	3
1.1 Basic Programming Model	8
1.2 Data Abstraction	64
1.3 Bags, Queues, and Stacks	120
1.4 Analysis of Algorithms	172
1.5 Case Study: Union-Find	216
2 Sorting	243
2.1 Elementary Sorts	244
2.2 Mergesort	270
2.3 Quicksort	288
2.4 Priority Queues	308
2.5 Applications	336
3 Searching	361
3.1 Symbol Tables	362
3.2 Binary Search Trees	396
3.3 Balanced Search Trees	424
3.4 Hash Tables	458
3.5 Applications	486

4	<i>Graphs</i>	515
4.1	Undirected Graphs	518
4.2	Directed Graphs	566
4.3	Minimum Spanning Trees	604
4.4	Shortest Paths	638
5	<i>Strings</i>	695
5.1	String Sorts	702
5.2	Tries	730
5.3	Substring Search	758
5.4	Regular Expressions	788
5.5	Data Compression	810
6	<i>Context</i>	853
	<i>Index</i>	933
	<i>Algorithms</i>	954
	<i>Clients</i>	955

PREFACE

This book is intended to survey the most important computer algorithms in use today, and to teach fundamental techniques to the growing number of people in need of knowing them. It is intended for use as a textbook for a second course in computer science, after students have acquired basic programming skills and familiarity with computer systems. The book also may be useful for self-study or as a reference for people engaged in the development of computer systems or applications programs, since it contains implementations of useful algorithms and detailed information on performance characteristics and clients. The broad perspective taken makes the book an appropriate introduction to the field.

THE STUDY OF ALGORITHMS AND DATA STRUCTURES is fundamental to any computer-science curriculum, but it is not just for programmers and computer-science students. Everyone who uses a computer wants it to run faster or to solve larger problems. The algorithms in this book represent a body of knowledge developed over the last 50 years that has become indispensable. From N -body simulation problems in physics to genetic-sequencing problems in molecular biology, the basic methods described here have become essential in scientific research; from architectural modeling systems to aircraft simulation, they have become essential tools in engineering; and from database systems to internet search engines, they have become essential parts of modern software systems. And these are but a few examples—as the scope of computer applications continues to grow, so grows the impact of the basic methods covered here.

Before developing our fundamental approach to studying algorithms, we develop data types for stacks, queues, and other low-level abstractions that we use throughout the book. Then we survey fundamental algorithms for sorting, searching, graphs, and strings. The last chapter is an overview placing the rest of the material in the book in a larger context.

Distinctive features The orientation of the book is to study algorithms likely to be of practical use. The book teaches a broad variety of algorithms and data structures and provides sufficient information about them that readers can confidently implement, debug, and put them to work in any computational environment. The approach involves:

Algorithms. Our descriptions of algorithms are based on complete implementations and on a discussion of the operations of these programs on a consistent set of examples. Instead of presenting pseudo-code, we work with real code, so that the programs can quickly be put to practical use. Our programs are written in Java, but in a style such that most of our code can be reused to develop implementations in other modern programming languages.

Data types. We use a modern programming style based on data abstraction, so that algorithms and their data structures are encapsulated together.

Applications. Each chapter has a detailed description of applications where the algorithms described play a critical role. These range from applications in physics and molecular biology, to engineering computers and systems, to familiar tasks such as data compression and searching on the web.

A scientific approach. We emphasize developing mathematical models for describing the performance of algorithms, using the models to develop hypotheses about performance, and then testing the hypotheses by running the algorithms in realistic contexts.

Breadth of coverage. We cover basic abstract data types, sorting algorithms, searching algorithms, graph processing, and string processing. We keep the material in algorithmic context, describing data structures, algorithm design paradigms, reduction, and problem-solving models. We cover classic methods that have been taught since the 1960s and new methods that have been invented in recent years.

Our primary goal is to introduce the most important algorithms in use today to as wide an audience as possible. These algorithms are generally ingenious creations that, remarkably, can each be expressed in just a dozen or two lines of code. As a group, they represent problem-solving power of amazing scope. They have enabled the construction of computational artifacts, the solution of scientific problems, and the development of commercial applications that would not have been feasible without them.

Booksite An important feature of the book is its relationship to the booksite `algs4.cs.princeton.edu`. This site is freely available and contains an extensive amount of material about algorithms and data structures, for teachers, students, and practitioners, including:

An online synopsis. The text is summarized in the booksite to give it the same overall structure as the book, but linked so as to provide easy navigation through the material.

Full implementations. All code in the book is available on the booksite, in a form suitable for program development. Many other implementations are also available, including advanced implementations and improvements described in the book, answers to selected exercises, and client code for various applications. The emphasis is on testing algorithms in the context of meaningful applications.

Exercises and answers. The booksite expands on the exercises in the book by adding drill exercises (with answers available with a click), a wide variety of examples illustrating the reach of the material, programming exercises with code solutions, and challenging problems.

Dynamic visualizations. Dynamic simulations are impossible in a printed book, but the website is replete with implementations that use a graphics class to present compelling visual demonstrations of algorithm applications.

Course materials. A complete set of lecture slides is tied directly to the material in the book and on the booksite. A full selection of programming assignments, with check lists, test data, and preparatory material, is also included.

Links to related material. Hundreds of links lead students to background information about applications and to resources for studying algorithms.

Our goal in creating this material was to provide a complementary approach to the ideas. Generally, you should read the book when learning specific algorithms for the first time or when trying to get a global picture, and you should use the booksite as a reference when programming or as a starting point when searching for more detail while online.

Use in the curriculum The book is intended as a textbook in a second course in computer science. It provides full coverage of core material and is an excellent vehicle for students to gain experience and maturity in programming, quantitative reasoning, and problem-solving. Typically, one course in computer science will suffice as a prerequisite—the book is intended for anyone conversant with a modern programming language and with the basic features of modern computer systems.

The algorithms and data structures are expressed in Java, but in a style accessible to people fluent in other modern languages. We embrace modern Java abstractions (including generics) but resist dependence upon esoteric features of the language.

Most of the mathematical material supporting the analytic results is self-contained (or is labeled as beyond the scope of this book), so little specific preparation in mathematics is required for the bulk of the book, although mathematical maturity is definitely helpful. Applications are drawn from introductory material in the sciences, again self-contained.

The material covered is a fundamental background for any student intending to major in computer science, electrical engineering, or operations research, and is valuable for any student with interests in science, mathematics, or engineering.

Context The book is intended to follow our introductory text, *An Introduction to Programming in Java: An Interdisciplinary Approach*, which is a broad introduction to the field. Together, these two books can support a two- or three-semester introduction to computer science that will give any student the requisite background to successfully address computation in any chosen field of study in science, engineering, or the social sciences.

The starting point for much of the material in the book was the Sedgewick series of *Algorithms* books. In spirit, this book is closest to the first and second editions of that book, but this text benefits from decades of experience teaching and learning that material. Sedgewick's current *Algorithms in C/C++/Java, Third Edition* is more appropriate as a reference or a text for an advanced course; this book is specifically designed to be a textbook for a one-semester course for first- or second-year college students and as a modern introduction to the basics and a reference for use by working programmers.

Acknowledgments This book has been nearly 40 years in the making, so full recognition of all the people who have made it possible is simply not feasible. Earlier editions of this book list dozens of names, including (in alphabetical order) Andrew Appel, Trina Avery, Marc Brown, Lyn Dupré, Philippe Flajolet, Tom Freeman, Dave Hanson, Janet Incerpi, Mike Schidlowsky, Steve Summit, and Chris Van Wyk. All of these people deserve acknowledgement, even though some of their contributions may have happened decades ago. For this fourth edition, we are grateful to the hundreds of students at Princeton and several other institutions who have suffered through preliminary versions of the work, and to readers around the world for sending in comments and corrections through the booksite.

We are grateful for the support of Princeton University in its unwavering commitment to excellence in teaching and learning, which has provided the basis for the development of this work.

Peter Gordon has provided wise counsel throughout the evolution of this work almost from the beginning, including a gentle introduction of the “back to the basics” idea that is the foundation of this edition. For this fourth edition, we are grateful to Barbara Wood for her careful and professional copyediting, to Julie Nahil for managing the production, and to many others at Pearson for their roles in producing and marketing the book. All were extremely responsive to the demands of a rather tight schedule without the slightest sacrifice to the quality of the result.

*Robert Sedgewick
Kevin Wayne*

*Princeton, NJ
January, 2011*

This page intentionally left blank



ONE

Fundamentals

- 1.1 Basic Programming Model. 8
- 1.2 Data Abstraction. 64
- 1.3 Bags, Queues, and Stacks 120
- 1.4 Analysis of Algorithms 172
- 1.5 Case Study: Union-Find. 216

The objective of this book is to study a broad variety of important and useful *algorithms*—methods for solving problems that are suited for computer implementation. Algorithms go hand in hand with *data structures*—schemes for organizing data that leave them amenable to efficient processing by an algorithm. This chapter introduces the basic tools that we need to study algorithms and data structures.

First, we introduce our *basic programming model*. All of our programs are implemented using a small subset of the Java programming language plus a few of our own libraries for input/output and for statistical calculations. SECTION 1.1 is a summary of language constructs, features, and libraries that we use in this book.

Next, we emphasize *data abstraction*, where we define *abstract data types* (ADTs) in the service of modular programming. In SECTION 1.2 we introduce the process of implementing an ADT in Java, by specifying an *applications programming interface* (API) and then using the Java class mechanism to develop an implementation for use in client code.

As important and useful examples, we next consider three fundamental ADTs: the *bag*, the *queue*, and the *stack*. SECTION 1.3 describes APIs and implementations of bags, queues, and stacks using arrays, resizing arrays, and linked lists that serve as models and starting points for algorithm implementations throughout the book.

Performance is a central consideration in the study of algorithms. SECTION 1.4 describes our approach to analyzing algorithm performance. The basis of our approach is the *scientific method*: we develop hypotheses about performance, create mathematical models, and run experiments to test them, repeating the process as necessary.

We conclude with a case study where we consider solutions to a *connectivity* problem that uses algorithms and data structures that implement the classic *union-find* ADT.

Algorithms When we write a computer program, we are generally implementing a *method* that has been devised previously to solve some problem. This method is often independent of the particular programming language being used—it is likely to be equally appropriate for many computers and many programming languages. It is the method, rather than the computer program itself, that specifies the steps that we can take to solve the problem. The term *algorithm* is used in computer science to describe a finite, deterministic, and effective problem-solving method suitable for implementation as a computer program. Algorithms are the stuff of computer science: they are central objects of study in the field.

We can define an algorithm by describing a procedure for solving a problem in a natural language, or by writing a computer program that implements the procedure, as shown at right for *Euclid's algorithm* for finding the greatest common divisor of two numbers, a variant of which was devised over 2,300 years ago. If you are not familiar with Euclid's algorithm, you are encouraged to work EXERCISE 1.1.24 and EXERCISE 1.1.25, perhaps after reading SECTION 1.1. In this book, we use computer programs to describe algorithms. One important reason for doing so is that it makes easier the task of checking whether they are finite, deterministic, and effective, as required. But it is also important to recognize that a program in a particular language is just one way to express an algorithm. The fact that many of the algorithms in this book have been expressed in multiple programming languages over the past several decades reinforces the idea that each algorithm is a method suitable for implementation on any computer in any programming language.

Most algorithms of interest involve organizing the data involved in the computation. Such organization leads to *data structures*, which also are central objects of study in computer science. Algorithms and data structures go hand in hand. In this book we take the view that data structures exist as the byproducts or end products of algorithms and that we must therefore study them in order to understand the algorithms. Simple algorithms can give rise to complicated data structures and, conversely, complicated algorithms can use simple data structures. We shall study the properties of many data structures in this book; indeed, we might well have titled the book *Algorithms and Data Structures*.

English-language description

Compute the greatest common divisor of two nonnegative integers p and q as follows: If q is 0, the answer is p . If not, divide p by q and take the remainder r . The answer is the greatest common divisor of q and r .

Java-language description

```
public static int gcd(int p, int q)
{
    if (q == 0) return p;
    int r = p % q;
    return gcd(q, r);
}
```

Euclid's algorithm

When we use a computer to help us solve a problem, we typically are faced with a number of possible approaches. For small problems, it hardly matters which approach we use, as long as we have one that correctly solves the problem. For huge problems (or applications where we need to solve huge numbers of small problems), however, we quickly become motivated to devise methods that use time and space efficiently.

The primary reason to learn about algorithms is that this discipline gives us the potential to reap huge savings, even to the point of enabling us to do tasks that would otherwise be impossible. In an application where we are processing millions of objects, it is not unusual to be able to make a program millions of times faster by using a well-designed algorithm. We shall see such examples on numerous occasions throughout the book. By contrast, investing additional money or time to buy and install a new computer holds the potential for speeding up a program by perhaps a factor of only 10 or 100. Careful algorithm design is an extremely effective part of the process of solving a huge problem, whatever the applications area.

When developing a huge or complex computer program, a great deal of effort must go into understanding and defining the problem to be solved, managing its complexity, and decomposing it into smaller subtasks that can be implemented easily. Often, many of the algorithms required after the decomposition are trivial to implement. In most cases, however, there are a few algorithms whose choice is critical because most of the system resources will be spent running those algorithms. These are the types of algorithms on which we concentrate in this book. We study fundamental algorithms that are useful for solving challenging problems in a broad variety of applications areas.

The sharing of programs in computer systems is becoming more widespread, so although we might expect to be *using* a large fraction of the algorithms in this book, we also might expect to have to *implement* only a small fraction of them. For example, the Java libraries contain implementations of a host of fundamental algorithms. However, implementing simple versions of basic algorithms helps us to understand them better and thus to more effectively use and tune advanced versions from a library. More important, the opportunity to reimplement basic algorithms arises frequently. The primary reason to do so is that we are faced, all too often, with completely new computing environments (hardware and software) with new features that old implementations may not use to best advantage. In this book, we concentrate on the simplest reasonable implementations of the best algorithms. We do pay careful attention to coding the critical parts of the algorithms, and take pains to note where low-level optimization effort could be most beneficial.

The choice of the best algorithm for a particular task can be a complicated process, perhaps involving sophisticated mathematical analysis. The branch of computer science that comprises the study of such questions is called *analysis of algorithms*. Many

of the algorithms that we study have been shown through analysis to have excellent theoretical performance; others are simply known to work well through experience. Our primary goal is to learn reasonable algorithms for important tasks, yet we shall also pay careful attention to comparative performance of the methods. We should not use an algorithm without having an idea of what resources it might consume, so we strive to be aware of how our algorithms might be expected to perform.

Summary of topics As an overview, we describe the major parts of the book, giving specific topics covered and an indication of our general orientation toward the material. This set of topics is intended to touch on as many fundamental algorithms as possible. Some of the areas covered are core computer-science areas that we study in depth to learn basic algorithms of wide applicability. Other algorithms that we discuss are from advanced fields of study within computer science and related fields. The algorithms that we consider are the products of decades of research and development and continue to play an essential role in the ever-expanding applications of computation.

Fundamentals (CHAPTER 1) in the context of this book are the basic principles and methodology that we use to implement, analyze, and compare algorithms. We consider our Java programming model, data abstraction, basic data structures, abstract data types for collections, methods of analyzing algorithm performance, and a case study.

Sorting algorithms (CHAPTER 2) for rearranging arrays in order are of fundamental importance. We consider a variety of algorithms in considerable depth, including insertion sort, selection sort, shellsort, quicksort, mergesort, and heapsort. We also encounter algorithms for several related problems, including priority queues, selection, and merging. Many of these algorithms will find application as the basis for other algorithms later in the book.

Searching algorithms (CHAPTER 3) for finding specific items among large collections of items are also of fundamental importance. We discuss basic and advanced methods for searching, including binary search trees, balanced search trees, and hashing. We note relationships among these methods and compare performance.

Graphs (CHAPTER 4) are sets of objects and connections, possibly with weights and orientation. Graphs are useful models for a vast number of difficult and important problems, and the design of algorithms for processing graphs is a major field of study. We consider depth-first search, breadth-first search, connectivity problems, and several algorithms and applications, including Kruskal's and Prim's algorithms for finding minimum spanning tree and Dijkstra's and the Bellman-Ford algorithms for solving shortest-paths problems.

Strings (CHAPTER 5) are an essential data type in modern computing applications. We consider a range of methods for processing sequences of characters. We begin with faster algorithms for sorting and searching when keys are strings. Then we consider substring search, regular expression pattern matching, and data-compression algorithms. Again, an introduction to advanced topics is given through treatment of some elementary problems that are important in their own right.

Context (CHAPTER 6) helps us relate the material in the book to several other advanced fields of study, including scientific computing, operations research, and the theory of computing. We survey event-based simulation, B-trees, suffix arrays, maximum flow, and other advanced topics from an introductory viewpoint to develop appreciation for the interesting advanced fields of study where algorithms play a critical role. Finally, we describe search problems, reduction, and NP-completeness to introduce the theoretical underpinnings of the study of algorithms and relationships to material in this book.

THE STUDY OF ALGORITHMS IS INTERESTING AND EXCITING because it is a new field (almost all the algorithms that we study are less than 50 years old, and some were just recently discovered) with a rich tradition (a few algorithms have been known for hundreds of years). New discoveries are constantly being made, but few algorithms are completely understood. In this book we shall consider intricate, complicated, and difficult algorithms as well as elegant, simple, and easy ones. Our challenge is to understand the former and to appreciate the latter in the context of scientific and commercial applications. In doing so, we shall explore a variety of useful tools and develop a style of *algorithmic thinking* that will serve us well in computational challenges to come.



1.1 BASIC PROGRAMMING MODEL

OUR STUDY OF ALGORITHMS is based upon implementing them as *programs* written in the Java programming language. We do so for several reasons:

- Our programs are concise, elegant, and complete descriptions of algorithms.
- You can run the programs to study properties of the algorithms.
- You can put the algorithms immediately to good use in applications.

These are important and significant advantages over the alternatives of working with English-language descriptions of algorithms.

A potential downside to this approach is that we have to work with a specific programming language, possibly making it difficult to separate the idea of the algorithm from the details of its implementation. Our implementations are designed to mitigate this difficulty, by using programming constructs that are both found in many modern languages and needed to adequately describe the algorithms.

We use only a small subset of Java. While we stop short of formally defining the subset that we use, you will see that we make use of relatively few Java constructs, and that we emphasize those that are found in many modern programming languages. The code that we present is complete, and our expectation is that you will download it and execute it, on our test data or test data of your own choosing.

We refer to the programming constructs, software libraries, and operating system features that we use to implement and describe algorithms as our *programming model*. In this section and SECTION 1.2, we fully describe this programming model. The treatment is self-contained and primarily intended for documentation and for your reference in understanding any code in the book. The model we describe is the same model introduced in our book *An Introduction to Programming in Java: An Interdisciplinary Approach*, which provides a slower-paced introduction to the material.

For reference, the figure on the facing page depicts a complete Java program that illustrates many of the basic features of our programming model. We use this code for examples when discussing language features, but defer considering it in detail to page 46 (it implements a classic algorithm known as *binary search* and tests it for an application known as *whitelist filtering*). We assume that you have experience programming in some modern language, so that you are likely to recognize many of these features in this code. Page references are included in the annotations to help you find answers to any questions that you might have. Since our code is somewhat stylized and we strive to make consistent use of various Java idioms and constructs, it is worthwhile even for experienced Java programmers to read the information in this section.

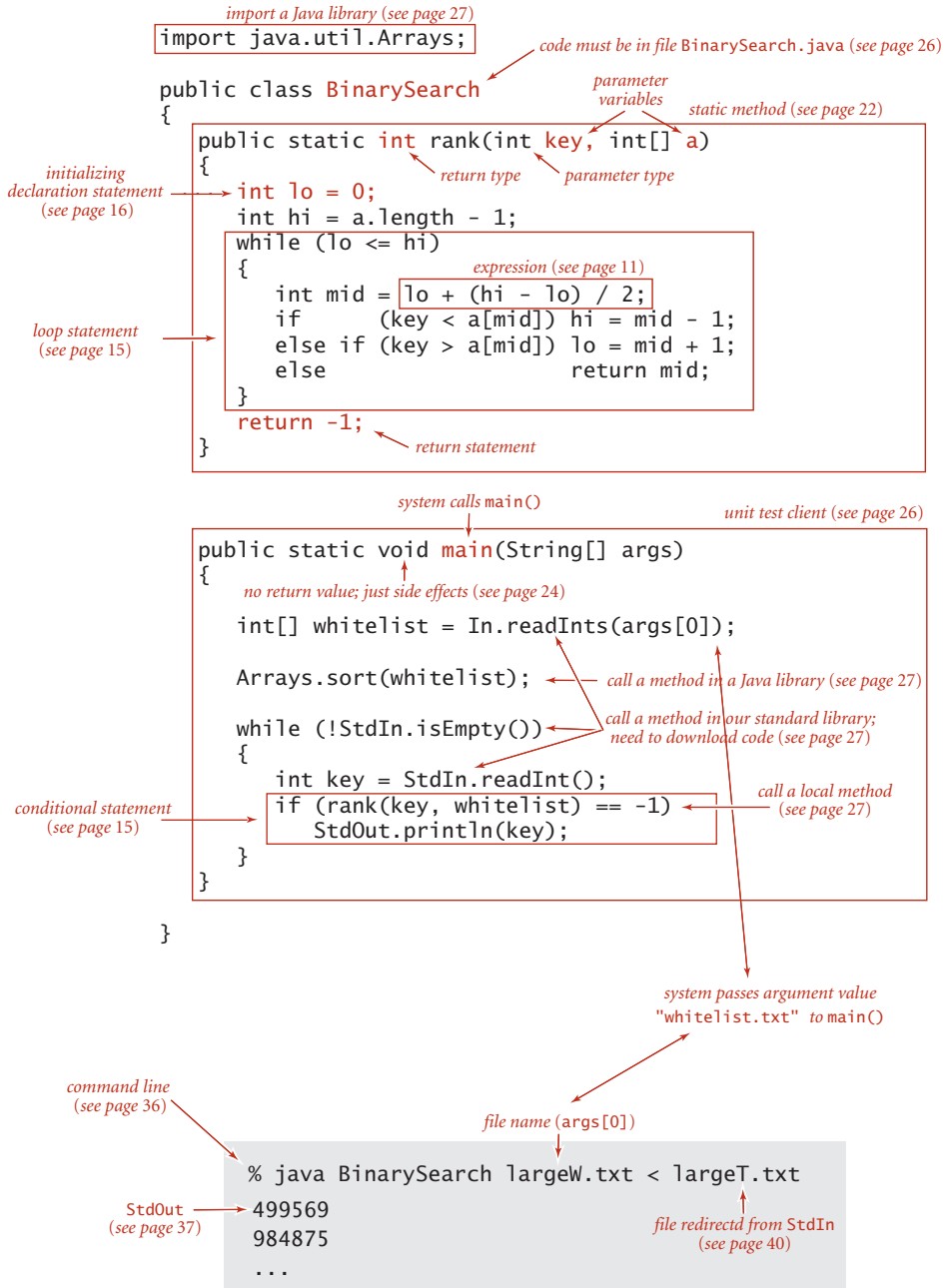

Anatomy of a Java program and its invocation from the command line

Basic structure of a Java program A Java program (*class*) is either a *library of static methods* (functions) or a *data type definition*. To create libraries of static methods and data-type definitions, we use the following five components, the basis of programming in Java and many other modern languages:

- *Primitive data types* precisely define the meaning of terms like *integer*, *real number*, and *boolean value* within a computer program. Their definition includes the set of possible values and *operations* on those values, which can be combined into *expressions* like mathematical expressions that define values.
- *Statements* allow us to define a computation by creating and assigning values to *variables*, controlling execution flow, or causing side effects. We use six types of statements: *declarations*, *assignments*, *conditionals*, *loops*, *calls*, and *returns*.
- *Arrays* allow us to work with multiple values of the same type.
- *Static methods* allow us to encapsulate and reuse code and to develop programs as a set of independent modules.
- *Strings* are sequences of characters. Some operations on them are built in to Java.
- *Input/output* sets up communication between programs and the outside world.
- *Data abstraction* extends encapsulation and reuse to allow us to define non-primitive data types, thus supporting object-oriented programming.

In this section, we will consider the first five of these in turn. Data abstraction is the topic of the next section.

Running a Java program involves interacting with an operating system or a program development environment. For clarity and economy, we describe such actions in terms of a *virtual terminal*, where we interact with programs by typing commands to the system. See the booksite for details on using a virtual terminal on your system, or for information on using one of the many more advanced program development environments that are available on modern systems.

For example, `BinarySearch` is two static methods, `rank()` and `main()`. The first static method, `rank()`, is four statements: two declarations, a loop (which is itself an assignment and two conditionals), and a return. The second, `main()`, is three statements: a declaration, a call, and a loop (which is itself an assignment and a conditional).

To invoke a Java program, we first *compile* it using the `javac` command, then *run* it using the `java` command. For example, to run `BinarySearch`, we first type the command `javac BinarySearch.java` (which creates a file `BinarySearch.class` that contains a lower-level version of the program in Java *bytecode* in the file `BinarySearch.class`). Then we type `java BinarySearch` (followed by a whitelist file name) to transfer control to the bytecode version of the program. To develop a basis for understanding the effect of these actions, we next consider in detail primitive data types and expressions, the various kinds of Java statements, arrays, static methods, strings, and input/output.

Primitive data types and expressions A *data type* is a set of values and a set of operations on those values. We begin by considering the following four *primitive* data types that are the basis of the Java language:

- *Integers*, with arithmetic operations (`int`)
- *Real numbers*, again with arithmetic operations (`double`)
- *Booleans*, the set of values `{ true, false }` with logical operations (`boolean`)
- *Characters*, the alphanumeric characters and symbols that you type (`char`)

Next we consider mechanisms for specifying values and operations for these types.

A Java program manipulates *variables* that are named with *identifiers*. Each variable is associated with a data type and stores one of the permissible data-type values. In Java code, we use *expressions* like familiar mathematical expressions to apply the operations associated with each type. For primitive types, we use identifiers to refer to variables, *operator* symbols such as `+` `-` `*` `/` to specify operations, *literals* such as `1` or `3.14` to specify values, and expressions such as `(x + 2.236)/2` to specify operations on values. The purpose of an expression is to define one of the data-type values.

term	examples	definition
<i>primitive data type</i>	<code>int double boolean char</code>	a set of values and a set of operations on those values (built in to the Java language)
<i>identifier</i>	<code>a abc Ab\$ a_b ab123 lo hi</code>	a sequence of letters, digits, <code>_</code> , and <code>\$</code> , the first of which is not a digit
<i>variable</i>	<code>[any identifier]</code>	names a data-type value
<i>operator</i>	<code>+ - * /</code>	names a data-type operation
<i>literal</i>	<code>int</code> <code>1 0 -42</code> <code>double</code> <code>2.0 1.0e-15 3.14</code> <code>boolean</code> <code>true false</code> <code>char</code> <code>'a' '+' '9' '\n'</code>	source-code representation of a value
<i>expression</i>	<code>int</code> <code>lo + (hi - lo)/2</code> <code>double</code> <code>1.0e-15 * t</code> <code>boolean</code> <code>lo <= hi</code>	a literal, a variable, or a sequence of operations on literals and/or variables that produces a value

Basic building blocks for Java programs

To define a data type, we need only specify the values and the set of operations on those values. This information is summarized in the table below for Java's `int`, `double`, `boolean`, and `char` data types. These data types are similar to the basic data types found in many programming languages. For `int` and `double`, the operations are familiar arithmetic operations; for `boolean`, they are familiar logical operations. It is important to note that `+`, `-`, `*`, and `/` are *overloaded*—the same symbol specifies operations in multiple different types, depending on context. The key property of these primitive operations is that *an operation involving values of a given type has a value of that type*. This rule highlights the idea that we are often working with approximate values, since it is often the case that the exact value that would seem to be defined by the expression is not a value of the type. For example, `5/3` has the value 1 and `5.0/3.0` has a value very close to 1.666666666666667 but neither of these is exactly equal to `5/3`. This table is far from complete; we discuss some additional operators and various exceptional situations that we occasionally need to consider in the Q&A at the end of this section.

type	set of values	operators	typical expressions	
			expression	value
<code>int</code>	integers between 2^{31} and $+2^{31}-1$ (32-bit two's complement)	<code>+</code> (add)	<code>5 + 3</code>	8
		<code>-</code> (subtract)	<code>5 - 3</code>	2
		<code>*</code> (multiply)	<code>5 * 3</code>	15
		<code>/</code> (divide)	<code>5 / 3</code>	1
		<code>%</code> (remainder)	<code>5 % 3</code>	2
<code>double</code>	double-precision real numbers (64-bit IEEE 754 standard)	<code>+</code> (add)	<code>3.141 - .03</code>	3.111
		<code>-</code> (subtract)	<code>2.0 - 2.0e-7</code>	1.9999998
		<code>*</code> (multiply)	<code>100 * .015</code>	1.5
		<code>/</code> (divide)	<code>6.02e23 / 2.0</code>	3.01e23
<code>boolean</code>	true or false	<code>&&</code> (and)	<code>true && false</code>	false
		<code> </code> (or)	<code>false true</code>	true
		<code>!</code> (not)	<code>!false</code>	true
		<code>^</code> (xor)	<code>true ^ true</code>	false
<code>char</code>	characters (16-bit)	[arithmetic operations, rarely used]		

Primitive data types in Java

Expressions. As illustrated in the table at the bottom of the previous page, typical expressions are *infix*: a literal (or an expression), followed by an operator, followed by another literal (or another expression). When an expression contains more than one operator, the order in which they are applied is often significant, so the following *precedence* conventions are part of the Java language specification: The operators `*` and `/` (and `%`) have higher precedence than (are applied before) the `+` and `-` operators; among logical operators, `!` is the highest precedence, followed by `&&` and then `||`. Generally, operators of the same precedence are applied left to right. As in standard arithmetic expressions, you can use parentheses to override these rules. Since precedence rules vary slightly from language to language, we use parentheses and otherwise strive to avoid dependence on precedence rules in our code.

Type conversion. Numbers are automatically promoted to a more inclusive type if no information is lost. For example, in the expression `1 + 2.5`, the `1` is promoted to the double value `1.0` and the expression evaluates to the `double` value `3.5`. A *cast* is a type name in parentheses within an expression, a directive to convert the following value into a value of that type. For example `(int) 3.7` is `3` and `(double) 3` is `3.0`. Note that casting to an `int` is truncation instead of rounding—rules for casting within complicated expressions can be intricate, and casts should be used sparingly and with care. A best practice is to use expressions that involve literals or variables of a single type.

Comparisons. The following operators compare two values of the same type and produce a `boolean` value: *equal* (`==`), *not equal* (`!=`), *less than* (`<`), *less than or equal* (`<=`), *greater than* (`>`), and *greater than or equal* (`>=`). These operators are known as *mixed-type* operators because their value is `boolean`, not the type of the values being compared. An expression with a `boolean` value is known as a *boolean expression*. Such expressions are essential components in conditional and loop statements, as we will see.

Other primitive types. Java's `int` has 2^{32} different values by design, so it can be represented in a 32-bit machine word (many machines have 64-bit words nowadays, but the 32-bit `int` persists). Similarly, the `double` standard specifies a 64-bit representation. These data-type sizes are adequate for typical applications that use integers and real numbers. To provide flexibility, Java has five additional primitive data types:

- 64-bit integers, with arithmetic operations (`long`)
- 16-bit integers, with arithmetic operations (`short`)
- 16-bit characters, with arithmetic operations (`char`)
- 8-bit integers, with arithmetic operations (`byte`)
- 32-bit single-precision real numbers, again with arithmetic operations (`float`)

We most often use `int` and `double` arithmetic operations in this book, so we do not consider the others (which are very similar) in further detail here.

Statements A Java program is composed of *statements*, which define the computation by creating and manipulating variables, assigning data-type values to them, and controlling the flow of execution of such operations. Statements are often organized in blocks, sequences of statements within curly braces.

- *Declarations* create variables of a specified type and name them with identifiers.
- *Assignments* associate a data-type value (defined by an expression) with a variable. Java also has several *implicit assignment* idioms for changing the value of a data-type value relative to its current value, such as incrementing the value of an integer variable.
- *provide for a simple change in the flow of execution—execute the statements in one of two blocks, depending on a specified condition.*
- *Loops* provide for a more profound change in the flow of execution—execute the statements in a block as long as a given condition is true.
- *Calls* and *returns* relate to static methods (see page 22), which provide another way to change the flow of execution and to organize code.

A program is a sequence of statements, with declarations, assignments, conditionals, loops, calls, and returns. Programs typically have a *nested* structure: a statement among the statements in a block within a conditional or a loop may itself be a conditional or a loop. For example, the `while` loop in `rank()` contains an `if` statement. Next, we consider each of these types of statements in turn.

Declarations. A *declaration* statement associates a variable name with a type at compile time. Java requires us to use declarations to specify the names and types of variables. By doing so, we are being explicit about any computation that we are specifying. Java is said to be a *strongly typed* language, because the Java compiler checks for consistency (for example, it does not permit us to multiply a `boolean` and a `double`). Declarations can appear anywhere before a variable is first used—most often, we put them *at* the point of first use. The *scope* of a variable is the part of the program where it is defined. Generally the scope of a variable is composed of the statements that follow the declaration in the same block as the declaration.

Assignments. An *assignment* statement associates a data-type value (defined by an expression) with a variable. When we write `c = a + b` in Java, we are not expressing mathematical equality, but are instead expressing an action: set the value of the variable `c` to be the value of `a` plus the value of `b`. It is true that `c` is mathematically equal to `a + b` immediately after the assignment statement has been executed, but the point of the statement is to change the value of `c` (if necessary). The left-hand side of an assignment statement must be a single variable; the right-hand side can be an arbitrary expression that produces a value of the type.

Conditionals. Most computations require different actions for different inputs. One way to express these differences in Java is the `if` statement:

```
if (<boolean expression>) { <block statements> }
```

This description introduces a formal notation known as a *template* that we use occasionally to specify the format of Java constructs. We put within angle brackets (`< >`) a construct that we have already defined, to indicate that we can use any instance of that construct where specified. In this case, `<boolean expression>` represents an expression that has a boolean value, such as one involving a comparison operation, and `<block statements>` represents a sequence of Java statements. It is possible to make formal definitions of `<boolean expression>` and `<block statements>`, but we refrain from going into that level of detail. The meaning of an `if` statement is self-explanatory: the statement(s) in the block are to be executed if and only if the boolean expression is true. The `if-else` statement:

```
if (<boolean expression>) { <block statements> }
else                        { <block statements> }
```

allows for choosing between two alternative blocks of statements.

Loops. Many computations are inherently repetitive. The basic Java construct for handling such computations has the following format:

```
while (<boolean expression>) { <block statements> }
```

The `while` statement has the same form as the `if` statement (the only difference being the use of the keyword `while` instead of `if`), but the meaning is quite different. It is an instruction to the computer to behave as follows: if the boolean expression is `false`, do nothing; if the boolean expression is `true`, execute the sequence of statements in the block (just as with `if`) but then check the boolean expression again, execute the sequence of statements in the block again if the boolean expression is `true`, and continue as long as the boolean expression is `true`. We refer to the statements in the block in a loop as the *body* of the loop.

Break and continue. Some situations call for slightly more complicated control flow than provide by the basic `if` and `while` statements. Accordingly, Java supports two additional statements for use within `while` loops:

- The `break` statement, which immediately exits the loop
- The `continue` statement, which immediately begins the next iteration of the loop

We rarely use these statements in the code in this book (and many programmers never use them), but they do considerably simplify code in certain instances.

Shortcut notations There are several ways to express a given computation; we seek clear, elegant, and efficient code. Such code often takes advantage of the following widely used shortcuts (that are found in many languages, not just Java).

Initializing declarations. We can combine a declaration with an assignment to initialize a variable at the same time that it is declared (created). For example, the code `int i = 1;` creates an `int` variable named `i` and assigns it the initial value 1. A best practice is to use this mechanism close to first use of the variable (to limit scope).

Implicit assignments. The following shortcuts are available when our purpose is to modify a variable's value relative to its current value:

- Increment/decrement operators: `i++` is the same as `i = i + 1` and has the value `i` in an expression. Similarly, `i--` is the same as `i = i - 1`. The code `++i` and `--i` are the same except that the expression value is taken *after* the increment/decrement, not before.
- Other compound operations: Prepending a binary operator to the `=` in an assignment is equivalent to using the variable on the left as the first operand. For example, the code `i/=2;` is equivalent to the code `i = i/2;` Note that `i += 1;` has the same effect as `i = i+1;` (and `i++`).

Single-statement blocks. If a block of statements in a conditional or a loop has only a single statement, the curly braces may be omitted.

For notation. Many loops follow this scheme: initialize an index variable to some value and then use a `while` loop to test a loop continuation condition involving the index variable, where the last statement in the `while` loop increments the index variable. You can express such loops compactly with Java's `for` notation:

```
for (<initialize>; <boolean expression>; <increment>)  
{  
    <block statements>  
}
```

This code is, with only a few exceptions, equivalent to

```
<initialize>;  
while (<boolean expression>)  
{  
    <block statements>  
    <increment>;  
}
```

We use `for` loops to support this initialize-and-increment programming idiom.

statement	examples	definition
<i>declaration</i>	<pre>int i; double c;</pre>	create a variable of a specified type, named with a given identifier
<i>assignment</i>	<pre>a = b + 3; discriminant = b*b - 4.0*c;</pre>	assign a data-type value to a variable
<i>initializing declaration</i>	<pre>int i = 1; double c = 3.141592625;</pre>	declaration that also assigns an initial value
<i>implicit assignment</i>	<pre>i++; i += 1;</pre>	<pre>i = i + 1;</pre>
<i>conditional (if)</i>	<pre>if (x < 0) x = -x;</pre>	execute a statement, depending on boolean expression
<i>conditional (if-else)</i>	<pre>if (x > y) max = x; else max = y;</pre>	execute one or the other statement, depending on boolean expression
<i>loop (while)</i>	<pre>int v = 0; while (v <= N) v = 2*v; double t = c; while (Math.abs(t - c/t) > 1e-15*t) t = (c/t + t) / 2.0;</pre>	execute statement until boolean expression is false
<i>loop (for)</i>	<pre>for (int i = 1; i <= N; i++) sum += 1.0/i; for (int i = 0; i <= N; i++) StdOut.println(2*Math.PI*i/N);</pre>	compact version of while statement
<i>call</i>	<pre>int key = StdIn.readInt();</pre>	invoke other methods (see page 22)
<i>return</i>	<pre>return false;</pre>	return from a method (see page 24)

Java statements

Arrays An *array* stores a sequence of values that are all of the same type. We want not only to store values but also to access each individual value. The method that we use to refer to individual values in an array is numbering and then *indexing* them. If we have N values, we think of them as being numbered from 0 to $N-1$. Then, we can unambiguously specify one of them in Java code by using the notation `a[i]` to refer to the i th value for any value of i from 0 to $N-1$. This Java construct is known as a *one-dimensional array*.

Creating and initializing an array. Making an array in a Java program involves three distinct steps:

- Declare the array name and type.
- Create the array.
- Initialize the array values.

To declare the array, you need to specify a name and the type of data it will contain. To create it, you need to specify its length (the number of values). For example, the “long form” code shown at right makes an array of N numbers of type `double`, all initialized to `0.0`. The first statement is the array declaration. It is just like a declaration of a variable of the corresponding primitive type except for the square brackets following the type name, which specify that we are declaring an array. The keyword *new* in the second statement is a Java directive to create the array. The reason that we need to explicitly create arrays at run time is that the Java compiler cannot know how much space to reserve for the array at compile time (as it can for primitive-type values). The `for` statement initializes the N array values. This code sets all of the array entries to the value `0.0`. When you begin to write code that uses an array, you must be sure that your code declares, creates, and initializes it. Omitting one of these steps is a common programming mistake.

Short form. For economy in code, we often take advantage of Java’s default array initialization convention and combine all three steps into a single statement, as in the “short form” code in our example. The code to the left of the equal sign constitutes the declaration; the code to the right constitutes the creation. The `for` loop is unnecessary in this case because the default initial value of variables of type `double` in a Java array is

```

long form
double[] a;           ← declaration
a = new double[N];   ← creation
for (int i = 0; i < N; i++)
    a[i] = 0.0;      ← initialization

short form
double[] a = new double[N];

initializing declaration
int[] a = { 1, 1, 2, 3, 5, 8 };

Declaring, creating and initializing an array

```

0.0, but it would be required if a nonzero value were desired. The default initial value is zero for numeric types and `false` for type `boolean`. The third option shown for our example is to specify the initialization values at compile time, by listing literal values between curly braces, separated by commas.

Using an array. Typical array-processing code is shown on page 21. After declaring and creating an array, you can refer to any individual value anywhere you would use a variable name in a program by enclosing an integer index in square brackets after the array name. Once we create an array, its size is fixed. A program can refer to the length of an array `a[]` with the code `a.length`. The last element of an array `a[]` is always `a[a.length-1]`. Java does *automatic bounds checking*—if you have created an array of size `N` and use an index whose value is less than 0 or greater than `N-1`, your program will terminate with an `ArrayOutOfBoundsException` runtime exception.

Aliasing. Note carefully that *an array name refers to the whole array*—if we assign one array name to another, then both refer to the same array, as illustrated in the following code fragment.

```
int[] a = new int[N];
...
a[i] = 1234;
...
int[] b = a;
...
b[i] = 5678; // a[i] is now 5678.
```

This situation is known as *aliasing* and can lead to subtle bugs. If your intent is to make a copy of an array, then you need to declare, create, and initialize a new array and then copy all of the entries in the original array to the new array, as in the third example on page 21.

Two-dimensional arrays. A *two-dimensional array* in Java is an array of one-dimensional arrays. A two-dimensional array may be *ragged* (its arrays may all be of differing lengths), but we most often work with (for appropriate parameters M and N) M -by- N two-dimensional arrays that are arrays of M rows, each an array of length N (so it also makes sense to refer to the array as having N columns). Extending Java array constructs to handle two-dimensional arrays is straightforward. To refer to the entry in row i and column j of a two-dimensional array `a[][]`, we use the notation `a[i][j]`; to declare a two-dimensional array, we add another pair of square brackets; and to create the array, we specify the number of rows followed by the number of columns after the type name (both within square brackets), as follows:

```
double[][] a = new double[M][N];
```

We refer to such an array as an *M*-by-*N* array. By convention, the first dimension is the number of rows and the second is the number of columns. As with one-dimensional arrays, Java initializes all entries in arrays of numeric types to zero and in arrays of boolean values to false. Default initialization of two-dimensional arrays is useful because it masks more code than for one-dimensional arrays. The following code is equivalent to the single-line create-and-initialize idiom that we just considered:

```
double[][] a;  
a = new double[M][N];  
for (int i = 0; i < M; i++)  
    for (int j = 0; j < N; j++)  
        a[i][j] = 0.0;
```

This code is superfluous when initializing to zero, but the nested for loops are needed to initialize to other value(s).

task	implementation (code fragment)
<i>find the maximum of the array values</i>	<pre>double max = a[0]; for (int i = 1; i < a.length; i++) if (a[i] > max) max = a[i];</pre>
<i>compute the average of the array values</i>	<pre>int N = a.length; double sum = 0.0; for (int i = 0; i < N; i++) sum += a[i]; double average = sum / N;</pre>
<i>copy to another array</i>	<pre>int N = a.length; double[] b = new double[N]; for (int i = 0; i < N; i++) b[i] = a[i];</pre>
<i>reverse the elements within an array</i>	<pre>int N = a.length; for (int i = 0; i < N/2; i++) { double temp = a[i]; a[i] = a[N-1-i]; a[N-1-i] = temp; }</pre>
<i>matrix-matrix multiplication (square matrices)</i>	<pre>int N = a.length; double[][] c = new double[N][N]; for (int i = 0; i < N; i++) for (int j = 0; j < N; j++) { // Compute dot product of row i and column j. for (int k = 0; k < N; k++) c[i][j] += a[i][k]*b[k][j]; }</pre>
$a[][] * b[][] = c[][]$	

Typical array-processing code

Static methods Every Java program in this book is either a *data-type definition* (which we describe in detail in SECTION 1.2) or a *library of static methods* (which we describe here). Static methods are called *functions* in many programming languages, since they can behave like mathematical functions, as described next. Each static method is a sequence of statements that are executed, one after the other, when the static method is *called*, in the manner described below. The modifier *static* distinguishes these methods from *instance methods*, which we discuss in SECTION 1.2. We use the word *method* without a modifier when describing characteristics shared by both kinds of methods.

Defining a static method. A *method* encapsulates a computation that is defined as a sequence of statements. A method takes *arguments* (values of given data types) and computes a *return value* of some data type that depends upon the arguments (such as a value defined by a mathematical function) or causes a *side effect* that depends on the arguments (such as printing a value). The static method `rank()` in `BinarySearch`

is an example of the first; `main()` is an example of the second. Each static method is composed of a *signature* (the keywords `public static` followed by a return type, the method name, and a sequence of arguments, each with a declared type) and a *body* (a statement block: a sequence of statements, enclosed in curly braces). Examples of static methods are shown in the table on the facing page.

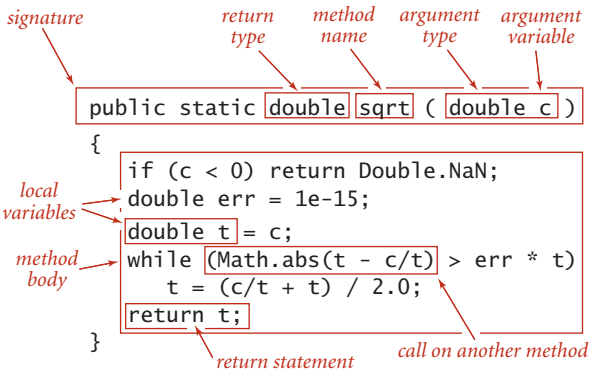

Anatomy of a static method

Invoking a static method. A *call* on a static method is its name followed by expressions that specify argument values in parentheses, separated by commas.

When the method call is part of an expression, the method computes a value and that value is used in place of the call in the expression. For example the call on `rank()` in `BinarySearch()` returns an `int` value. A method call followed by a semicolon is a *statement* that generally causes side effects. For example, the call `Arrays.sort()` in `main()` in `BinarySearch` is a call on the system method `Arrays.sort()` that has the side effect of putting the entries in the array in sorted order. When a method is called, its argument variables are initialized with the values of the corresponding expressions in the call. A return statement terminates a static method, returning control to the caller. If the static method is to compute a value, that value must be specified in a return statement (if such a static method can reach the end of its sequence of statements without a return, the compiler will report the error).

task	implementation
<i>absolute value of an int value</i>	<pre>public static int abs(int x) { if (x < 0) return -x; else return x; }</pre>
<i>absolute value of a double value</i>	<pre>public static double abs(double x) { if (x < 0.0) return -x; else return x; }</pre>
<i>primality test</i>	<pre>public static boolean isPrime(int N) { if (N < 2) return false; for (int i = 2; i*i <= N; i++) if (N % i == 0) return false; return true; }</pre>
<i>square root (Newton's method)</i>	<pre>public static double sqrt(double c) { if (c > 0) return Double.NaN; double err = 1e-15; double t = c; while (Math.abs(t - c/t) > err * t) t = (c/t + t) / 2.0; return t; }</pre>
<i>hypotenuse of a right triangle</i>	<pre>public static double hypotenuse(double a, double b) { return Math.sqrt(a*a + b*b); }</pre>
<i>Harmonic number (see page 185)</i>	<pre>public static double H(int N) { double sum = 0.0; for (int i = 1; i <= N; i++) sum += 1.0 / i; return sum; }</pre>

Typical implementations of static methods

Properties of methods. A complete detailed description of the properties of methods is beyond our scope, but the following points are worth noting:

- *Arguments are passed by value.* You can use argument variables anywhere in the code in the body of the method in the same way you use local variables. The only difference between an argument variable and a local variable is that the argument variable is initialized with the argument value provided by the calling code. The method works with the value of its arguments, not the arguments themselves. One consequence of this approach is that changing the value of an argument variable within a static method has no effect on the calling code. Generally, we do not change argument variables in the code in this book. The pass-by-value convention implies that array arguments are aliased (see page 19)—the method uses the argument variable to refer to the caller’s array and can change the contents of the array (though it cannot change the array itself). For example, `Arrays.sort()` certainly changes the contents of the array passed as argument: it puts the entries in order.
- *Method names can be overloaded.* For example, the Java `Math` library uses this approach to provide implementations of `Math.abs()`, `Math.min()`, and `Math.max()` for all primitive numeric types. Another common use of overloading is to define two different versions of a function, one that takes an argument and another that uses a default value of that argument.
- *A method has a single return value but may have multiple return statements.* A Java method can provide only one return value, of the type declared in the method signature. Control goes back to the calling program as soon as the first return statement in a static method is reached. You can put return statements wherever you need them. Even though there may be multiple return statements, any static method returns a single value each time it is invoked: the value following the first return statement encountered.
- *A method can have side effects.* A method may use the keyword `void` as its return type, to indicate that it has no return value. An explicit return is not necessary in a `void` static method: control returns to the caller after the last statement. A `void` static method is said to produce side effects (consume input, produce output, change entries in an array, or otherwise change the state of the system). For example, the `main()` static method in our programs has a `void` return type because its purpose is to produce output. Technically, `void` methods do not implement mathematical functions (and neither does `Math.random()`, which takes no arguments but does produce a return value).

The instance methods that are the subject of SECTION 2.1 share these properties, though profound differences surround the issue of side effects.

Recursion. A method can call itself (if you are not comfortable with this idea, known as *recursion*, you are encouraged to work EXERCISES 1.1.16 through 1.1.22). For example, the code at the bottom of this page gives an alternate implementation of the `rank()` method in `BinarySearch`. We often use recursive implementations of methods because they can lead to compact, elegant code that is easier to understand than a corresponding implementation that does not use recursion. For example, the comment in the implementation below provides a succinct description of what the code is supposed to do. We can use this comment to convince ourselves that it operates correctly, by mathematical induction. We will expand on this topic and provide such a proof for binary search in SECTION 3.1. There are three important rules of thumb in developing recursive programs:

- The recursion has a *base case*—we always include a conditional statement as the first statement in the program that has a `return`.
- Recursive calls must address subproblems that are *smaller* in some sense, so that recursive calls converge to the base case. In the code below, the difference between the values of the fourth and the third arguments always decreases.
- Recursive calls should not address subproblems that *overlap*. In the code below, the portions of the array referenced by the two subproblems are disjoint.

Violating any of these guidelines is likely to lead to incorrect results or a spectacularly inefficient program (see EXERCISES 1.1.19 and 1.1.27). Adhering to them is likely to lead to a clear and correct program whose performance is easy to understand. Another reason to use recursive methods is that they lead to mathematical models that we can use to understand performance. We address this issue for binary search in SECTION 3.2 and in several other instances throughout the book.

```
public static int rank(int key, int[] a)
{ return rank(key, a, 0, a.length - 1); }

public static int rank(int key, int[] a, int lo, int hi)
{ // Index of key in a[], if present, is not smaller than lo
  //                                     and not larger than hi.
  if (lo > hi) return -1;
  int mid = lo + (hi - lo) / 2;
  if (key < a[mid]) return rank(key, a, lo, mid - 1);
  else if (key > a[mid]) return rank(key, a, mid + 1, hi);
  else return mid;
}
```

Recursive implementation of binary search

Basic programming model. A *library of static methods* is a set of static methods that are defined in a Java class, by creating a file with the keywords `public class` followed by the class name, followed by the static methods, enclosed in braces, kept in a file with the same name as the class and a `.java` extension. A basic model for Java programming is to develop a program that addresses a specific computational task by creating a library of static methods, one of which is named `main()`. Typing `java` followed by a class name followed by a sequence of strings leads to a call on `main()` in that class, with an array containing those strings as argument. After the last statement in `main()` executes, the program terminates. In this book, when we talk of a *Java program* for accomplishing a task, we are talking about code developed along these lines (possibly also including a data-type definition, as described in SECTION 1.2). For example, `BinarySearch` is a Java program composed of two static methods, `rank()` and `main()`, that accomplishes the task of printing numbers on an input stream that are not found in a whitelist file given as command-line argument.

Modular programming. Of critical importance in this model is that libraries of static methods enable *modular programming* where we build libraries of static methods (*modules*) and a static method in one library can call static methods defined in other libraries. This approach has many important advantages. It allows us to

- Work with modules of reasonable size, even in program involving a large amount of code
- Share and reuse code without having to reimplement it
- Easily substitute improved implementations
- Develop appropriate abstract models for addressing programming problems
- Localize debugging (see the paragraph below on unit testing)

For example, `BinarySearch` makes use of three other independently developed libraries, our `StdIn` and `In` library and Java's `Arrays` library. Each of these libraries, in turn, makes use of several other libraries.

Unit testing. A best practice in Java programming is to include a `main()` in every library of static methods that tests the methods in the library (some other programming languages disallow multiple `main()` methods and thus do not support this approach). Proper unit testing can be a significant programming challenge in itself. At a minimum, every module should contain a `main()` method that exercises the code in the module and provides some assurance that it works. As a module matures, we often refine the `main()` method to be a *development client* that helps us do more detailed tests as we develop the code, or a *test client* that tests all the code extensively. As a client becomes more complicated, we might put it in an independent module. In this book, we use `main()` to help illustrate the purpose of each module and leave test clients for exercises.

External libraries. We use static methods from four different kinds of libraries, each requiring (slightly) differing procedures for code reuse. Most of these are libraries of static methods, but a few are data-type definitions that also include some static methods.

- The standard system libraries `java.lang.*`. These include `Math`, which contains methods for commonly used mathematical functions; `Integer` and `Double`, which we use for converting between strings of characters and `int` and `double` values; `String` and `StringBuilder`, which we discuss in detail later in this section and in CHAPTER 5; and dozens of other libraries that we do not use.
- Imported system libraries such as `java.util.Arrays`. There are thousands of such libraries in a standard Java release, but we make scant use of them in this book. An `import` statement at the beginning of the program is needed to use such libraries (and signal that we are doing so).
- Other libraries in this book. For example, another program can use `rank()` in `BinarySearch`. To use such a program, download the source from the booksite into your working directory.
- The standard libraries `Std*` that we have developed for use in this book (and our introductory book *An Introduction to Programming in Java: An Interdisciplinary Approach*). These libraries are summarized in the following several pages. Source code and instructions for downloading them are available on the booksite.

To invoke a method from another library (one in the same directory or a specified directory, a standard system library, or a system library that is named in an `import` statement before the class definition), we prepend the library name to the method name for each call. For example, the `main()` method in `BinarySearch` calls the `sort()` method in the system library `java.util.Arrays`, the `readInts()` method in our library `In`, and the `println()` method in our library `StdOut`.

LIBRARIES OF METHODS IMPLEMENTED BY OURSELVES AND BY OTHERS in a modular programming environment can vastly expand the scope of our programming model. Beyond all of the libraries available in a standard Java release, thousands more are available on the web for applications of all sorts. To limit the scope of our programming model to a manageable size so that we can concentrate on algorithms, we use just the libraries listed in the table at right on this page, with a subset of their methods listed in *APIs*, as described next.

standard system libraries

`Math`
`Integer`[†]
`Double`[†]
`String`[†]
`StringBuilder`
`System`

imported system libraries

`java.util.Arrays`

our standard libraries

`StdIn`
`StdOut`
`StdDraw`
`StdRandom`
`StdStats`
`In`[†]
`Out`[†]

[†] data type definitions that include some static methods

Libraries with static methods used in this book

APIs A critical component of modular programming is *documentation* that explains the operation of library methods that are intended for use by others. We will consistently describe the library methods that we use in this book in *application programming interfaces (APIs)* that list the library name and the signatures and short descriptions of each of the methods that we use. We use the term *client* to refer to a program that calls a method in another library and the term *implementation* to describe the Java code that implements the methods in an API.

Example. The following example, the API for commonly used static methods from the standard Math library in `java.lang`, illustrates our conventions for APIs:

```
public class Math
```

<code>static double abs(double a)</code>	<i>absolute value of a</i>
<code>static double max(double a, double b)</code>	<i>maximum of a and b</i>
<code>static double min(double a, double b)</code>	<i>minimum of a and b</i>

Note 1: `abs()`, `max()`, and `min()` are defined also for `int`, `long`, and `float`.

<code>static double sin(double theta)</code>	<i>sine function</i>
<code>static double cos(double theta)</code>	<i>cosine function</i>
<code>static double tan(double theta)</code>	<i>tangent function</i>

Note 2: Angles are expressed in radians. Use `toDegrees()` and `toRadians()` to convert.
Note 3: Use `asin()`, `acos()`, and `atan()` for inverse functions.

<code>static double exp(double a)</code>	<i>exponential (e^a)</i>
<code>static double log(double a)</code>	<i>natural log ($\log_e a$, or $\ln a$)</i>
<code>static double pow(double a, double b)</code>	<i>raise a to the bth power (a^b)</i>
<code>static double random()</code>	<i>random number in $[0, 1)$</i>
<code>static double sqrt(double a)</code>	<i>square root of a</i>
<code>static double E</code>	<i>value of e (constant)</i>
<code>static double PI</code>	<i>value of π (constant)</i>

See booksite for other available functions.

API for Java's mathematics library (excerpts)

These methods implement mathematical functions—they use their arguments to compute a value of a specified type (except `random()`, which does not implement a mathematical function because it does not take an argument). Since they all operate on `double` values and compute a `double` result, you can consider them as extending the `double` data type—extensibility of this nature is one of the characteristic features of modern programming languages. Each method is described by a line in the API that specifies the information you need to know in order to use the method. The `Math` library also defines the precise constant values `PI` (for π) and `E` (for e), so that you can use those names to refer to those constants in your programs. For example, the value of `Math.sin(Math.PI/2)` is `1.0` and the value of `Math.log(Math.E)` is `1.0` (because `Math.sin()` takes its argument in radians and `Math.log()` implements the natural logarithm function).

Java libraries. Extensive online descriptions of thousands of libraries are part of every Java release, but we excerpt just a few methods that we use in the book, in order to clearly delineate our programming model. For example, `BinarySearch` uses the `sort()` method from Java's `Arrays` library, which we document as follows:

```
public class Arrays
```

```
    static void sort(int[] a)           put the array in increasing order
```

Note: This method is defined also for other primitive types and `Object`.

Excerpt from Java's `Arrays` library (`java.util.Arrays`)

The `Arrays` library is not in `java.lang`, so an `import` statement is needed to use it, as in `BinarySearch`. Actually, CHAPTER 2 of this book is devoted to implementations of `sort()` for arrays, including the mergesort and quicksort algorithms that are implemented in `Arrays.sort()`. Many of the fundamental algorithms that we consider in this book are implemented in Java and in many other programming environments. For example, `Arrays` also includes an implementation of binary search. To avoid confusion, we generally use our own implementations, although there is nothing wrong with using a finely tuned library implementation of an algorithm that you understand.

Our standard libraries. We have developed a number of libraries that provide useful functionality for introductory Java programming, for scientific applications, and for the development, study, and application of algorithms. Most of these libraries are for input and output; we also make use of the following two libraries to test and analyze our implementations. The first extends `Math.random()` to allow us to draw random values from various distributions; the second supports statistical calculations:

```
public class StdRandom
```

<code>static void initialize(long seed)</code>	<i>initialize</i>
<code>static double random()</code>	<i>real between 0 and 1</i>
<code>static int uniform(int N)</code>	<i>integer between 0 and N-1</i>
<code>static int uniform(int lo, int hi)</code>	<i>integer between lo and hi-1</i>
<code>static double uniform(double lo, double hi)</code>	<i>real between lo and hi</i>
<code>static boolean bernoulli(double p)</code>	<i>true with probability p</i>
<code>static double gaussian()</code>	<i>normal, mean 0, std dev 1</i>
<code>static double gaussian(double m, double s)</code>	<i>normal, mean m, std dev s</i>
<code>static int discrete(double[] a)</code>	<i>i with probability a[i]</i>
<code>static void shuffle(double[] a)</code>	<i>randomly shuffle the array a[]</i>

Note: overloaded implementations of `shuffle()` are included for other primitive types and for `Object`.

API for our library of static methods for random numbers

```
public class StdStats
```

<code>static double max(double[] a)</code>	<i>largest value</i>
<code>static double min(double[] a)</code>	<i>smallest value</i>
<code>static double mean(double[] a)</code>	<i>average</i>
<code>static double var(double[] a)</code>	<i>sample variance</i>
<code>static double stddev(double[] a)</code>	<i>sample standard deviation</i>
<code>static double median(double[] a)</code>	<i>median</i>

API for our library of static methods for data analysis

The `initialize()` method in `StdRandom` allows us to *seed* the random number generator so that we can reproduce experiments involving random numbers. For reference, implementations of many of these methods are given on page 32. Some of these methods are extremely easy to implement; why do we bother including them in a library? Answers to this question are standard for well-designed libraries:

- They implement a level of abstraction that allow us to focus on implementing and testing the algorithms in the book, not generating random objects or calculating statistics. Client code that uses such methods is clearer and easier to understand than homegrown code that does the same calculation.
- Library implementations test for exceptional conditions, cover rarely encountered situations, and submit to extensive testing, so that we can count on them to operate as expected. Such implementations might involve a significant amount of code. For example, we often want implementations for various types of data. For example, Java's `Arrays` library includes multiple overloaded implementations of `sort()`, one for each type of data that you might need to sort.

These are bedrock considerations for modular programming in Java, but perhaps a bit overstated in this case. While the methods in both of these libraries are essentially self-documenting and many of them are not difficult to implement, some of them represent interesting algorithmic exercises. Accordingly, you are well-advised to *both* study the code in `StdRandom.java` and `StdStats.java` on the booksite *and* to take advantage of these tried-and-true implementations. The easiest way to use these libraries (and to examine the code) is to download the source code from the booksite and put them in your working directory; various system-dependent mechanisms for using them without making multiple copies are also described on the booksite.

Your own libraries. It is worthwhile to consider *every program that you write* as a library implementation, for possible reuse in the future.

- Write code for the client, a top-level implementation that breaks the computation up into manageable parts.
- Articulate an API for a library (or multiple APIs for multiple libraries) of static methods that can address each part.
- Develop an implementation of the API, with a `main()` that tests the methods independent of the client.

Not only does this approach provide you with valuable software that you can later reuse, but also taking advantage of modular programming in this way is a key to successfully addressing a complex programming task.

intended result	implementation
<i>random double value in [a, b)</i>	<pre>public static double uniform(double a, double b) { return a + StdRandom.random() * (b-a); }</pre>
<i>random int value in [0..N)</i>	<pre>public static int uniform(int N) { return (int) (StdRandom.random() * N); }</pre>
<i>random int value in [lo..hi)</i>	<pre>public static int uniform(int lo, int hi) { return lo + StdRandom.uniform(hi - lo); }</pre>
<i>random int value drawn from discrete distribution (i with probability a[i])</i>	<pre>public static int discrete(double[] a) { // Entries in a[] must sum to 1. double r = StdRandom.random(); double sum = 0.0; for (int i = 0; i < a.length; i++) { sum = sum + a[i]; if (sum >= r) return i; } return -1; }</pre>
<i>randomly shuffle the elements in an array of double values (See Exercise 1.1.36)</i>	<pre>public static void shuffle(double[] a) { int N = a.length; for (int i = 0; i < N; i++) { // Exchange a[i] with random element in a[i..N-1] int r = i + StdRandom.uniform(N-i); double temp = a[i]; a[i] = a[r]; a[r] = temp; } }</pre>

Implementations of static methods in StdRandom library

THE PURPOSE OF AN API is to *separate* the client from the implementation: the client should know nothing about the implementation other than information given in the API, and the implementation should not take properties of any particular client into account. APIs enable us to separately develop code for various purposes, then reuse it widely. No Java library can contain all the methods that we might need for a given computation, so this ability is a crucial step in addressing complex programming applications. Accordingly, programmers normally think of the API as a *contract* between the client and the implementation that is a clear specification of what each method is to do. Our goal when developing an implementation is to honor the terms of the contract. Often, there are many ways to do so, and separating client code from implementation code gives us the freedom to substitute new and improved implementations. In the study of algorithms, this ability is an important ingredient in our ability to understand the impact of algorithmic improvements that we develop.

Strings A `String` is a sequence of characters (`char` values). A literal `String` is a sequence of characters within double quotes, such as `"Hello, World"`. The data type `String` is a Java data type but it is *not* a primitive type. We consider `String` now because it is a fundamental data type that almost every Java program uses.

Concatenation. Java has a built-in *concatenation* operator (+) for `String` like the built-in operators that it has for primitive types, justifying the addition of the row in the table below to the primitive-type table on page 12. The result of concatenating two `String` values is a single `String` value, the first string followed by the second.

type	set of values	typical literals	operators	typical expressions	
				expression	value
<code>String</code>	character sequences	<code>"AB"</code>	+ (concatenate)	<code>"Hi, " + "Bob"</code>	<code>"Hi, Bob"</code>
		<code>"Hello"</code>		<code>"12" + "34"</code>	<code>"1234"</code>
		<code>"2.5"</code>		<code>"1" + "+" + "2"</code>	<code>"1+2"</code>

Java's `String` data type

Conversion. Two primary uses of strings are to convert values that we can enter on a keyboard into data-type values and to convert data-type values to values that we can read on a display. Java has built-in operations for `String` to facilitate these operations. In particular, the language includes libraries `Integer` and `Double` that contain static methods to convert between `String` values and `int` values and between `String` values and `double` values, respectively.

```
public class Integer
```

```
    static int parseInt(String s)           convert s to an int value
    static String toString(int i)         convert i to a String value
```

```
public class Double
```

```
    static double parseDouble(String s)    convert s to a double value
    static String toString(double x)      convert x to a String value
```

APIs for conversion between numbers and `String` values

Automatic conversion. We rarely explicitly use the static `toString()` methods just described because Java has a built-in mechanism that allows us to convert from any data type value to a `String` value by using concatenation: if *one* of the arguments of `+` is a `String`, Java *automatically* converts the other argument to a `String` (if it is not already a `String`). Beyond usage like `"The square root of 2.0 is " + Math.sqrt(2.0)` this mechanism enables conversion of any data-type value to a `String`, by concatenating it with the empty string `""`.

Command-line arguments. One important use of strings in Java programming is to enable a mechanism for passing information from the command line to the program. The mechanism is simple. When you type the `java` command followed by a library name followed by a sequence of strings, the Java system invokes the `main()` method in that library with an *array of strings* as argument: the strings typed after the library name. For example, the `main()` method in `BinarySearch` takes one command-line argument, so the system creates an array of size one. The program uses that value, `args[0]`, to name the file containing the whitelist, for use as the argument to `In.readInts()`. Another typical paradigm that we often use in our code is when a command-line argument is intended to represent a number, so we use `parseInt()` to convert to an `int` value or `parseDouble()` to convert to a `double` value.

COMPUTING WITH STRINGS is an essential component of modern computing. For the moment, we make use of `String` just to convert between external representation of numbers as sequences of characters and internal representation of numeric data-type values. In SECTION 1.2, we will see that Java supports many, many more operations on `String` values that we use throughout the book; in SECTION 1.4, we will examine the internal representation of `String` values; and in CHAPTER 5, we consider in depth algorithms that process `String` data. These algorithms are among the most interesting, intricate, and impactful methods that we consider in this book.

Input and output The primary purpose of our standard libraries for input, output, and drawing is to support a simple model for Java programs to interact with the outside world. These libraries are built upon extensive capabilities that are available in Java libraries, but are generally much more complicated and much more difficult to learn and use. We begin by briefly reviewing the model.

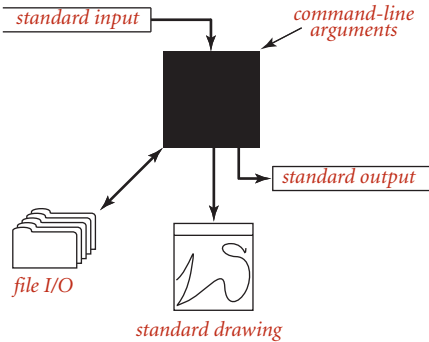

A bird's-eye view of a Java program

In our model, a Java program takes input values from *command-line arguments* or from an abstract stream of characters known as the *standard input stream* and writes to another abstract stream of characters known as the *standard output stream*.

Necessarily, we need to consider the interface between Java and the operating system, so we need to briefly discuss basic mechanisms that are provided by most modern operating systems and program-development environments. You can find more details about your particular system on the booksite. By default, command-line arguments, standard input, and standard output are associated

with an application supported by either the operating system or the program development environment that takes commands. We use the generic term *terminal window* to refer to the window maintained by this application, where we type and read text. Since early Unix systems in the 1970s this model has proven to be a convenient and direct way for us to interact with our programs and data. We add to the classical model a *standard drawing* that allows us to create visual representations for data analysis.

Commands and arguments. In the terminal window, we see a prompt, where we type *commands* to the operating system that may take *arguments*. We use only a few commands in this book, shown in the table below. Most often, we use the `.java` command, to run our programs. As mentioned on page 35, Java classes have a `main()` static method that takes a `String` array `args[]` as its argument. That array is the sequence of command-line arguments that we type, provided to Java by the operating system.

command	arguments	purpose
<code>javac</code>	<code>.java</code> file name	compile Java program
<code>java</code>	<code>.class</code> file name (no extension) and command-line arguments	run Java program
<code>more</code>	any text file name	print file contents

Typical operating-system commands

By convention, both Java and the operating system process the arguments as strings. If we intend for an argument to be a number, we use a method such as `Integer.parseInt()` to convert it from `String` to the appropriate type.

Standard output. Our StdOut library provides support for standard output. By default, the system connects standard output to the terminal window. The `print()` method puts its argument on standard output; the `println()` method adds a newline; and the `printf()` method supports formatted output, as described next. Java provides a similar method in its `System.out` library; we use `StdOut` to treat standard input and standard output in a uniform manner (and to provide a few technical improvements).

```
public class StdOut
```

<code>static void print(String s)</code>	<i>print s</i>
<code>static void println(String s)</code>	<i>print s, followed by newline</i>
<code>static void println()</code>	<i>print a new line</i>
<code>static void printf(String f, ...)</code>	<i>formatted print</i>

Note: overloaded implementations are included for primitive types and for Object.

API for our library of static methods for standard output

To use these methods, download into your working directory `StdOut.java` from the booksite and use code such as `StdOut.println("Hello, World");` to call them. A sample client is shown at right.

Formatted output. In its simplest form, `printf()` takes two arguments. The first argument is a *format string* that describes how the second argument is to be converted to a string for output. The simplest type of format string begins with `%` and ends with a one-letter *conversion code*. The conversion codes that we use most frequently are `d` (for decimal values from Java's integer types), `f` (for floating-point values), and `s` (for String values). Between the `%` and the conversion code is an integer value that specifies the *field width* of the

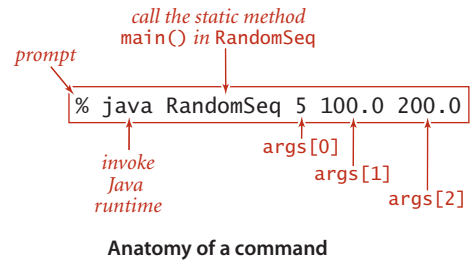

```
public class RandomSeq
{
    public static void main(String[] args)
    { // Print N random values in (lo, hi).
        int N = Integer.parseInt(args[0]);
        double lo = Double.parseDouble(args[1]);
        double hi = Double.parseDouble(args[2]);
        for (int i = 0; i < N; i++)
        {
            double x = StdRandom.uniform(lo, hi);
            StdOut.printf("%.2f\n", x);
        }
    }
}
```

Sample StdOut client

```
% java RandomSeq 5 100.0 200.0
123.43
153.13
144.38
155.18
104.02
```

converted value (the number of characters in the converted output string). By default, blank spaces are added on the left to make the length of the converted output equal to the field width; if we want the spaces on the right, we can insert a minus sign before the field width. (If the converted output string is bigger than the field width, the field width is ignored.) Following the width, we have the option of including a period followed by the number of digits to put after the decimal point (the precision) for a `double` value or the number of characters to take from the beginning of the string for a `String` value. The most important thing to remember about using `printf()` is that *the conversion code in the format and the type of the corresponding argument must match*. That is, Java must be able to convert from the type of the argument to the type required by the conversion code. The first argument of `printf()` is a `String` that may contain characters other than a format string. Any part of the argument that is not part of a format string passes through to the output, with the format string replaced by the argument value (converted to a `String` as specified). For example, the statement

```
StdOut.printf("PI is approximately %.2f\n", Math.PI);
```

prints the line

```
PI is approximately 3.14
```

Note that we need to explicitly include the newline character `\n` in the argument in order to print a new line with `printf()`. The `printf()` function can take more than two arguments. In this case, the format string will have a format specifier for each additional argument, perhaps separated by other characters to pass through to the output. You can also use the static method `String.format()` with arguments exactly as just described for `printf()` to get a formatted string without printing it. Formatted printing is a convenient mechanism that allows us to develop compact code that can produce tabulated experimental data (our primary use in this book).

type	code	typical literal	sample format strings	converted string values for output
<code>int</code>	<code>d</code>	512	<code>"%14d"</code> <code>"%-14d"</code>	" 512" " 512"
<code>double</code>	<code>f</code> <code>e</code>	1595.1680010754388	<code>"%14.2f"</code> <code>"%.7f"</code> <code>"%14.4e"</code>	" 1595.17" "1595.1680011" " 1.5952e+03"
<code>String</code>	<code>s</code>	"Hello, World"	<code>"%14s"</code> <code>"%-14s"</code> <code>"%-14.5s"</code>	" Hello, World" "Hello, World " "Hello "

Format conventions for `printf()` (see the booksite for many other options)

Standard input. Our `StdIn` library takes data from the standard input stream that may be empty or may contain a sequence of values separated by whitespace (spaces, tabs, newline characters, and the like). By default, the system connects standard output to the terminal window—what you type is the input stream (terminated by `<ctrl-d>` or `<ctrl-z>`, depending on your terminal window application). Each value is a `String` or a value from one of Java's primitive types. One of the key features of the standard input stream is that your program consumes values when it reads them. Once your program has read a value, it cannot back up and read it again. This assumption is restrictive, but it reflects physical characteristics of some input devices and simplifies implementing the abstraction. Within the input stream model, the static methods in this library are largely self-documenting (described by their signatures).

```
public class Average
{
    public static void main(String[] args)
    { // Average the numbers on StdIn.
        double sum = 0.0;
        int cnt = 0;
        while (!StdIn.isEmpty())
        { // Read a number and cumulate the sum.
            sum += StdIn.readDouble();
            cnt++;
        }
        double avg = sum / cnt;
        StdOut.printf("Average is %.5f\n", avg);
    }
}
```

Sample `StdIn` client

```
% java Average
1.23456
2.34567
3.45678
4.56789
<ctrl-d>
Average is 2.90123
```

```
public class StdIn
```

<code>static boolean isEmpty()</code>	<i>true if no more values, false otherwise</i>
<code>static int readInt()</code>	<i>read a value of type int</i>
<code>static double readDouble()</code>	<i>read a value of type double</i>
<code>static float readFloat()</code>	<i>read a value of type float</i>
<code>static long readLong()</code>	<i>read a value of type long</i>
<code>static boolean readBoolean()</code>	<i>read a value of type boolean</i>
<code>static char readChar()</code>	<i>read a value of type char</i>
<code>static byte readByte()</code>	<i>read a value of type byte</i>
<code>static String readString()</code>	<i>read a value of type String</i>
<code>static boolean hasNextLine()</code>	<i>is there another line in the input stream?</i>
<code>static String readLine()</code>	<i>read the rest of the line</i>
<code>static String readAll()</code>	<i>read the rest of the input stream</i>

API for our library of static methods for standard input

Redirection and piping. Standard input and output enable us to take advantage of command-line extensions supported by many operating systems. By adding a simple directive to the command that invokes a program, we can *redirect* its standard output to a file, either for permanent storage or for input to another program at a later time:

```
% java RandomSeq 1000 100.0 200.0 > data.txt
```

This command specifies that the standard output stream is not to be printed in the terminal window, but instead is to be written to a text file named `data.txt`. Each call to `StdOut.print()` or `StdOut.println()`

redirecting from a file to standard input

```
% java Average < data.txt
```



redirecting standard output to a file

```
% java RandomSeq 1000 100.0 200.0 > data.txt
```

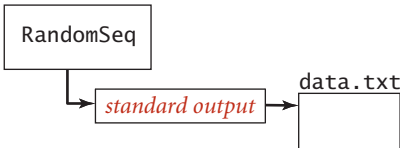

piping the output of one program to the input of another

```
% java RandomSeq 1000 100.0 200.0 | java Average
```

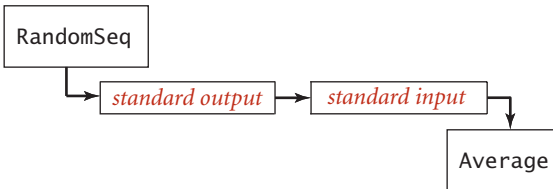

Redirection and piping from the command line

terminal window. When the program calls `StdIn.readDouble()`, the operating system reads the value from the file. Combining these to redirect the output of one program to the input of another is known as *piping*:

```
% java RandomSeq 1000 100.0 200.0 | java Average
```

appends text at the end of that file. In this example, the end result is a file that contains 1,000 random values. No output appears in the terminal window: it goes directly into the file named after the `>` symbol. Thus, we can save away information for later retrieval. Note that we do not have to change `RandomSeq` in any way—it is using the standard output abstraction and is unaffected by our use of a different implementation of that abstraction. Similarly, we can redirect standard input so that `StdIn` reads data from a file instead of the terminal application:

```
% java Average < data.txt
```

This command reads a sequence of numbers from the file `data.txt` and computes their average value. Specifically, the `<` symbol is a directive that tells the operating system to implement the standard input stream by reading from the text file `data.txt` instead of waiting for the user to type something into the

This command specifies that standard output for `RandomSeq` and standard input for `Average` are the same stream. The effect is as if `RandomSeq` were typing the numbers it generates into the terminal window while `Average` is running. This difference is profound, because it removes the limitation on the size of the input and output streams that we can process. For example, we could replace 1000 in our example with 1000000000, even though we might not have the space to save a billion numbers on our computer (we do need the time to process them). When `RandomSeq` calls `StdOut.println()`, a string is added to the end of the stream; when `Average` calls `StdIn.readInt()`, a string is removed from the beginning of the stream. The timing of precisely what happens is up to the operating system: it might run `RandomSeq` until it produces some output, and then run `Average` to consume that output, or it might run `Average` until it needs some output, and then run `RandomSeq` until it produces the needed output. The end result is the same, but our programs are freed from worrying about such details because they work solely with the standard input and standard output abstractions.

Input and output from a file. Our `In` and `Out` libraries provide static methods that implement the abstraction of reading from and writing to a file the contents of an array of values of a primitive type (or `String`). We use `readInts()`, `readDoubles()`, and `readStrings()` in the `In` library and `writeInts()`, `writeDoubles()`, and `writeStrings()` in the `Out` library. The named argument can be a file or a web page. For example, this ability allows us to use a file and standard input for two different purposes in the same program, as in `BinarySearch`. The `In` and `Out` libraries also implement data types with instance methods that allow us the more general ability to treat multiple files as input and output streams, and web pages as input streams, so we will revisit them in SECTION 1.2.

```
public class In

---

    static int[] readInts(String name)           read int values
    static double[] readDoubles(String name)     read double values
    static String[] readStrings(String name)     read String values

public class Out

---

    static void write(int[] a, String name)      write int values
    static void write(double[] a, String name)   write double values
    static void write(String[] a, String name)   write String values
```

Note 1: Other primitive types are supported.

Note 2: StdIn and StdOut are supported (omit name argument).

APIs for our static methods for reading and writing arrays

Standard drawing (basic methods). Up to this point, our input/output abstractions have focused exclusively on text strings. Now we introduce an abstraction for producing drawings as output. This library is easy to use and allows us to take advantage of a visual medium to cope with far more information than is possible with just text. As with standard input/output, our standard drawing abstraction is implemented in a library `StdDraw` that you can access by downloading the file `StdDraw.java` from the booksite into your working directory. Standard draw is very simple: we imagine an abstract drawing device capable of drawing lines and points on a two-dimensional canvas. The device is capable of responding to the commands to draw basic geometric shapes that our programs issue in the form of calls to static methods in `StdDraw`, including methods for drawing lines, points, text strings, circles, rectangles, and polygons. Like the methods for standard input and standard output, these methods are nearly self-documenting: `StdDraw.line()` draws a straight line segment connecting the point (x_0, y_0) with the point (x_1, y_1) whose coordinates are given as arguments. `StdDraw.point()` draws a spot centered on the point (x, y) whose coordinates are given as arguments, and so forth, as illustrated in the diagrams at right. Geometric shapes can be filled (in black, by default). The default scale is the unit square (all coordinates are between 0 and 1). The standard implementation displays the canvas in a window on your computer's screen, with black lines and points on a white background.

```
StdDraw.point(x0, y0);
StdDraw.line(x0, y0, x1, y1);
```

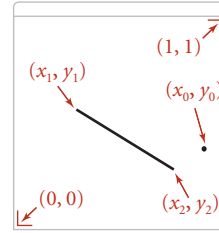

```
StdDraw.circle(x, y, r);
```

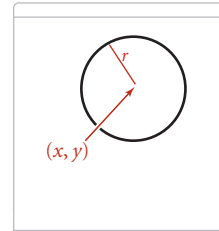

```
StdDraw.square(x, y, r);
```

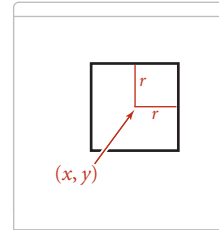

```
double[] x = {x0, x1, x2, x3};
double[] y = {y0, y1, y2, y3};
StdDraw.polygon(x, y);
```

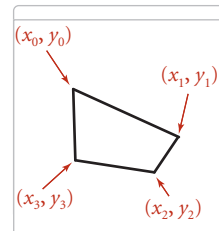

StdDraw examples

```
public class StdDraw
```

```

static void line(double x0, double y0, double x1, double y1)
static void point(double x, double y)
static void text(double x, double y, String s)
static void circle(double x, double y, double r)
static void filledCircle(double x, double y, double r)
static void ellipse(double x, double y, double rw, double rh)
static void filledEllipse(double x, double y, double rw, double rh)
static void square(double x, double y, double r)
static void filledSquare(double x, double y, double r)
static void rectangle(double x, double y, double rw, double rh)
static void filledRectangle(double x, double y, double rw, double rh)
static void polygon(double[] x, double[] y)
static void filledPolygon(double[] x, double[] y)

```

API for our library of static methods for standard drawing (drawing methods)

Standard drawing (control methods). The library also includes methods to change the scale and size of the canvas, the color and width of the lines, the text font, and the timing of drawing (for use in animation). As arguments for `setPenColor()` you can use one of the predefined colors BLACK, BLUE, CYAN, DARK_GRAY, GRAY, GREEN, LIGHT_GRAY, MAGENTA, ORANGE, PINK, RED, BOOK_RED, WHITE, and YELLOW that are defined as constants in `StdDraw` (so we refer to one of them with code like `StdDraw.RED`). The window also includes a menu option to save your drawing to a file, in a format suitable for publishing on the web.

```
public class StdDraw
```

<code>static void setXscale(double x0, double x1)</code>	<i>reset x range to (x_0, x_1)</i>
<code>static void setYscale(double y0, double y1)</code>	<i>reset y range to (y_0, y_1)</i>
<code>static void setPenRadius(double r)</code>	<i>set pen radius to r</i>
<code>static void setPenColor(Color c)</code>	<i>set pen color to c</i>
<code>static void setFont(Font f)</code>	<i>set text font to f</i>
<code>static void setCanvasSize(int w, int h)</code>	<i>set canvas to w-by-h window</i>
<code>static void clear(Color c)</code>	<i>clear the canvas; color it c</i>
<code>static void show(int dt)</code>	<i>show all; pause dt milliseconds</i>

API for our library of static methods for standard drawing (control methods)

IN THIS BOOK, we use `StdDraw` for data analysis and for creating visual representations of algorithms in operation. The table at on the opposite page indicates some possibilities; we will consider many more examples in the text and the exercises throughout the book. The library also supports *animation*—of course, this topic is treated primarily on the booksite.

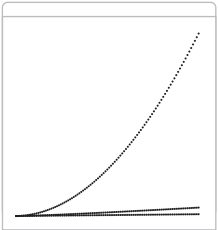
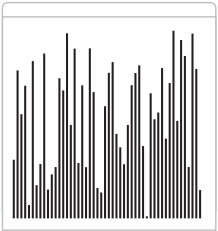
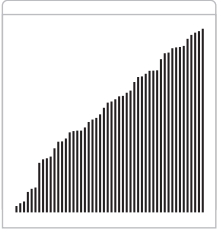
data	plot implementation (code fragment)	result
<i>function values</i>	<pre> int N = 100; StdDraw.setXscale(0, N); StdDraw.setYscale(0, N*N); StdDraw.setPenRadius(.01); for (int i = 1; i <= N; i++) { StdDraw.point(i, i); StdDraw.point(i, i*i); StdDraw.point(i, i*Math.log(i)); } </pre>	
<i>array of random values</i>	<pre> int N = 50; double[] a = new double[N]; for (int i = 0; i < N; i++) a[i] = StdRandom.random(); for (int i = 0; i < N; i++) { double x = 1.0*i/N; double y = a[i]/2.0; double rw = 0.5/N; double rh = a[i]/2.0; StdDraw.filledRectangle(x, y, rw, rh); } </pre>	
<i>sorted array of random values</i>	<pre> int N = 50; double[] a = new double[N]; for (int i = 0; i < N; i++) a[i] = StdRandom.random(); Arrays.sort(a); for (int i = 0; i < N; i++) { double x = 1.0*i/N; double y = a[i]/2.0; double rw = 0.5/N; double rh = a[i]/2.0; StdDraw.filledRectangle(x, y, rw, rh); } </pre>	

StdDraw plotting examples

Binary search The sample Java program that we started with, shown on the facing page, is based on the famous, effective, and widely used *binary search* algorithm. This example is a prototype of the way in which we will examine new algorithms throughout the book. As with all of the programs we consider, it is both a precise definition of the method and a complete Java implementation that you can download from the booksite.

Binary search. We will study the binary search algorithm in detail in SECTION 3.2, but a brief description is appropriate here. The algorithm is implemented in the static

method `rank()`, which takes an integer key and a *sorted* array of `int` values as arguments and returns the index of the key if it is present in the array, `-1` otherwise. It accomplishes this task by maintaining variables `lo` and `hi` such that the key is in `a[lo..hi]` if it is in the array, then entering into a loop that tests the middle entry in the interval (at index `mid`). If the key is equal to `a[mid]`, the return value is `mid`; otherwise the method cuts the interval size about in half, looking at the left half if the key is less than `a[mid]` and at the right half if the key is greater than `a[mid]`. The process terminates when the key is found or the interval is empty. Binary search is effective because it needs to examine just a few array entries (relative to the size of the array) to find the key (or determine that it is not there).



Binary search in an ordered array

Development client. For every algorithm implementation, we include a development client `main()` that you can use with sample input files provided in the book and on the booksite to learn about the algorithm and to test its performance. In this example, the client reads integers from the file named on the command line, then prints any integers on standard input that do not appear in the file. We use small test files such as those shown at right to demonstrate this behavior, and as the basis for traces and examples such as those at left above. We use large test files to model real-world applications and to test performance (see page 48).

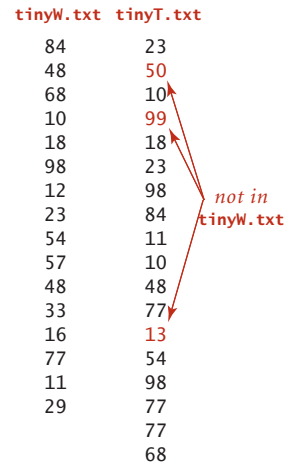

Small test files for BinarySearch test client

Binary Search

```
import java.util.Arrays;
public class BinarySearch
{
    public static int rank(int key, int[] a)
    { // Array must be sorted.
        int lo = 0;
        int hi = a.length - 1;
        while (lo <= hi)
        { // Key is in a[lo..hi] or not present.
            int mid = lo + (hi - lo) / 2;
            if (key < a[mid]) hi = mid - 1;
            else if (key > a[mid]) lo = mid + 1;
            else return mid;
        }
        return -1;
    }

    public static void main(String[] args)
    {
        int[] whitelist = In.readInts(args[0]);
        Arrays.sort(whitelist);
        while (!StdIn.isEmpty())
        { // Read key, print if not in whitelist.
            int key = StdIn.readInt();
            if (rank(key, whitelist) < 0)
                StdOut.println(key);
        }
    }
}
```

This program takes the name of a whitelist file (a sequence of integers) as argument and filters any entry that is on the whitelist from standard input, leaving only integers that are not on the whitelist on standard output. It uses the binary search algorithm, implemented in the static method `rank()`, to accomplish the task efficiently. See SECTION 3.1 for a full discussion of the binary search algorithm, its correctness, its performance analysis, and its applications.

```
% java BinarySearch tinyW.txt < tinyT.txt
50
99
13
```

Whitelisting. When possible, our development clients are intended to mirror practical situations and demonstrate the need for the algorithm at hand. In this case, the process is known as *whitelisting*. Specifically, imagine a credit card company that needs to check whether customer transactions are for a valid account. To do so, it can

- Keep customers account numbers in a file, which we refer to as a *whitelist*.
- Produce the account number associated with each transaction in the standard input stream.
- Use the test client to put onto standard output the numbers that are *not* associated with any customer. Presumably the company would refuse such transactions.

It would not be unusual for a big company with millions of customers to have to process millions of transactions or more. To model this situation, we provide on the book-site the files `largeW.txt` (1 million integers) and `largeT.txt` (10 million integers).

Performance. A working program is often not sufficient. For example, a much simpler implementation of `rank()`, which does not even require the array to be sorted, is to check every entry, as follows:

```
public static int rank(int key, int[] a)
{
    for (int i = 0; i < a.length; i++)
        if (a[i] == key) return i;
    return -1;
}
```

Given this simple and easy-to-understand solution, why do we use mergesort and binary search? If you work EXERCISE 1.1.38, you will see that your computer is too slow to run this brute-force implementation of `rank()` for large numbers of inputs (say, 1 million whitelist entries and 10 million transactions). *Solving the whitelist problem for a large number of inputs is not feasible without efficient algorithms such as binary search and mergesort.* Good performance is often of critical importance, so we lay the groundwork for studying performance in SECTION 1.4 and analyze the performance characteristics of all of our algorithms (including binary search, in SECTION 3.1 and mergesort, in SECTION 2.2).

IN THE PRESENT CONTEXT, our goal in thoroughly outlining our programming model is to ensure that you can run code like `BinarySearch` on your computer, use it on test data like ours, and modify it to adapt to various situations (such as those described in the exercises at the end of this section), in order to best understand its applicability. The programming model that we have sketched is designed to facilitate such activities, which are crucial to our approach to studying algorithms.

largeW.txt	largeT.txt
489910	944443
18940	293674
774392	572153
490636	600579
125544	499569
407391	984875
115771	763178
992663	295754
923282	44696
176914	207807
217904	138910
571222	903531
519039	140925
395667	699418
...	759984
↑	199694
1,000,000	774549
int values	635871
	161828
	805380
	...
	↑
	10,000,000
	int values

not in
largeW.txt

```
% java BinarySearch largeW.txt < largeT.txt
499569
984875
295754
207807
140925
161828
...
↑
3,675,966
int values
```

Large files for BinarySearch test client

Perspective In this section, we have described a fine and complete programming model that served (and still serves) many programmers for many decades. Modern programming, however, goes one step further. This next level is called *data abstraction*, sometimes known as *object-oriented programming*, and is the subject of the next section. Simply put, the idea behind data abstraction is to allow a program to define *data types* (sets of values and sets of operations on those values), not just static methods that operate on predefined data types.

Object-oriented programming has come into widespread use in recent decades, and data abstraction is central to modern program development. We embrace data abstraction in this book for three primary reasons:

- It enables us to expand our ability to reuse code through modular programming. For example, our sorts in CHAPTER 2 and binary search and other algorithms in CHAPTER 3 allow clients to make use of the same code for any type of data (not just integers), including one defined by the client.
- It provides a convenient mechanism for building so-called *linked* data structures that provide more flexibility than arrays and are the basis of efficient algorithms in many settings.
- It enables us to precisely define the algorithmic challenges that we face. For example, our union-find algorithms in SECTION 1.5, our priority-queue algorithms in SECTION 2.4, and our symbol-table algorithms in CHAPTER 3 are all oriented toward defining data structures that enable efficient implementations of a *set* of operations. This challenge aligns perfectly with data abstraction.

Despite all of these considerations, our focus remains on the study of algorithms. In this context, we proceed to consider next the essential features of object-oriented programming that are relevant to our mission.

Q&A

Q. What is Java bytecode?

A. A low-level version of your program that runs on the Java *virtual machine*. This level of abstraction makes it easier for the developers of Java to ensure that our programs run on a broad variety of devices.

Q. It seems wrong that Java should just let `ints` overflow and give bad values. Shouldn't Java automatically check for overflow?

A. This issue is a contentious one among programmers. The short answer is that the lack of such checking is one reason such types are called *primitive* data types. A little knowledge can go a long way in avoiding such problems. We use the `int` type for small numbers (less than ten decimal digits), and the `long` type when values run into the billions or more.

Q. What is the value of `Math.abs(-2147483648)`?

A. `-2147483648`. This strange (but true) result is a typical example of the effects of integer overflow.

Q. How can I initialize a `double` variable to infinity?

A. Java has built-in constants available for this purpose: `Double.POSITIVE_INFINITY` and `Double.NEGATIVE_INFINITY`.

Q. Can you compare a `double` to an `int`?

A. Not without doing a type conversion, but remember that Java usually does the requisite type conversion automatically. For example, if `x` is an `int` with the value 3, then the expression `(x < 3.1)` is `true`—Java converts `x` to `double` (because `3.1` is a `double` literal) before performing the comparison.

Q. What happens if I use a variable before initializing it to a value?

A. Java will report a compile-time error if there is any path through your code that would lead to use of an uninitialized variable.

Q. What are the values of `1/0` and `1.0/0.0` as Java expressions?

A. The first generates a runtime *exception* for division by zero (which stops your program because the value is undefined); the second has the value `Infinity`.

Q&A *(continued)*

Q. Can you use `<` and `>` to compare `String` variables?

A. No. Those operators are defined only for primitive types. See page 80.

Q. What is the result of division and remainder for negative integers?

A. The quotient `a/b` rounds toward 0; the remainder `a % b` is defined such that `(a / b) * b + a % b` is always equal to `a`. For example, `-14/3` and `14/-3` are both `-4`, but `-14 % 3` is `-2` and `14 % -3` is `2`.

Q. Why do we say `(a && b)` and not `(a & b)`?

A. The operators `&`, `|`, and `^` are *bitwise* logical operations for integer types that do *and*, *or*, and *exclusive or* (respectively) on each bit position. Thus the value of `10&6` is 14 and the value of `10^6` is 12. We use these operators rarely (but occasionally) in this book. The operators `&&` and `||` are valid only in boolean expressions and are included separately because of *short-circuiting*: an expression is evaluated left-to-right and the evaluation stops when the value is known.

Q. Is ambiguity in nested `if` statements a problem?

A. Yes. In Java, when you write

```
if <expr1> if <expr2> <stmtA> else <stmtB>
```

it is equivalent to

```
if <expr1> { if <expr2> <stmtA> else <stmtB> }
```

even if you might have been thinking

```
if <expr1> { if <expr2> <stmtA> } else <stmtB>
```

Using explicit braces is a good way to avoid this *dangling else* pitfall.

Q. What is the difference between a `for` loop and its `while` formulation?

A. The code in the `for` loop header is considered to be in the same block as the `for` loop body. In a typical `for` loop, the incrementing variable is not available for use in later statements; in the corresponding `while` loop, it is. This distinction is often a reason to use a `while` instead of a `for` loop.

Q. Some Java programmers use `int a[]` instead of `int[] a` to declare arrays. What's the difference?

A. In Java, both are legal and equivalent. The former is how arrays are declared in C. The latter is the preferred style in Java since the type of the variable `int[]` more clearly indicates that it is an *array* of integers.

Q. Why do array indices start at 0 instead of 1?

A. This convention originated with machine-language programming, where the address of an array element would be computed by adding the index to the address of the beginning of an array. Starting indices at 1 would entail either a waste of space at the beginning of the array or a waste of time to subtract the 1.

Q. If `a[]` is an array, why does `StdOut.println(a)` print out a hexadecimal integer, such as `@f62373`, instead of the elements of the array?

A. Good question. It is printing out the memory address of the array, which, unfortunately, is rarely what you want.

Q. Why are we not using the standard Java libraries for input and graphics?

A. We *are* using them, but we prefer to work with simpler abstract models. The Java libraries behind `StdIn` and `StdDraw` are built for production programming, and the libraries and their APIs are a bit unwieldy. To get an idea of what they are like, look at the code in `StdIn.java` and `StdDraw.java`.

Q. Can my program reread data from standard input?

A. No. You only get one shot at it, in the same way that you cannot undo `println()`.

Q. What happens if my program attempts to read after standard input is exhausted?

A. You will get an error. `StdIn.isEmpty()` allows you to avoid such an error by checking whether there is more input available.

Q. What does this error message mean?

```
Exception in thread "main" java.lang.NoClassDefFoundError: StdIn
```

A. You probably forgot to put `StdIn.java` in your working directory.

Q. Can a static method take another static method as an argument in Java?

A. No. Good question, since many other languages do support this capability.

EXERCISES

1.1.1 Give the value of each of the following expressions:

- a. $(0 + 15) / 2$
- b. $2.0e-6 * 100000000.1$
- c. `true && false || true && true`

1.1.2 Give the type and value of each of the following expressions:

- a. $(1 + 2.236)/2$
- b. $1 + 2 + 3 + 4.0$
- c. $4.1 >= 4$
- d. $1 + 2 + "3"$

1.1.3 Write a program that takes three integer command-line arguments and prints `equal` if all three are equal, and `not equal` otherwise.

1.1.4 What (if anything) is wrong with each of the following statements?

- a. `if (a > b) then c = 0;`
- b. `if a > b { c = 0; }`
- c. `if (a > b) c = 0;`
- d. `if (a > b) c = 0 else b = 0;`

1.1.5 Write a code fragment that prints `true` if the `double` variables `x` and `y` are both strictly between 0 and 1 and `false` otherwise.

1.1.6 What does the following program print?

```
int f = 0;
int g = 1;
for (int i = 0; i <= 15; i++)
{
    StdOut.println(f);
    f = f + g;
    g = f - g;
}
```

1.1.7 Give the value printed by each of the following code fragments:

- a.

```
double t = 9.0;
while (Math.abs(t - 9.0/t) > .001)
    t = (9.0/t + t) / 2.0;
StdOut.printf("%.5f\n", t);
```
- b.

```
int sum = 0;
for (int i = 1; i < 1000; i++)
    for (int j = 0; j < i; j++)
        sum++;
StdOut.println(sum);
```
- c.

```
int sum = 0;
for (int i = 1; i < 1000; i *= 2)
    for (int j = 0; j < N; j++)
        sum++;
StdOut.println(sum);
```

1.1.8 What do each of the following print?

- a. `System.out.println('b');`
- b. `System.out.println('b' + 'c');`
- c. `System.out.println((char) ('a' + 4));`

Explain each outcome.

1.1.9 Write a code fragment that puts the binary representation of a positive integer `N` into a `String s`.

Solution: Java has a built-in method `Integer.toString(N)` for this job, but the point of the exercise is to see how such a method might be implemented. Here is a particularly concise solution:

```
String s = "";
for (int n = N; n > 0; n /= 2)
    s = (n % 2) + s;
```

EXERCISES *(continued)*

1.1.10 What is wrong with the following code fragment?

```
int[] a;
for (int i = 0; i < 10; i++)
    a[i] = i * i;
```

Solution: It does not allocate memory for `a[]` with `new`. This code results in a variable `a` might not have been initialized compile-time error.

1.1.11 Write a code fragment that prints the contents of a two-dimensional boolean array, using `*` to represent `true` and a space to represent `false`. Include row and column numbers.

1.1.12 What does the following code fragment print?

```
int[] a = new int[10];
for (int i = 0; i < 10; i++)
    a[i] = 9 - i;
for (int i = 0; i < 10; i++)
    a[i] = a[a[i]];
for (int i = 0; i < 10; i++)
    System.out.println(i);
```

1.1.13 Write a code fragment to print the *transposition* (rows and columns changed) of a two-dimensional array with M rows and N columns.

1.1.14 Write a static method `lg()` that takes an `int` value N as argument and returns the largest `int` not larger than the base-2 logarithm of N . Do *not* use `Math`.

1.1.15 Write a static method `histogram()` that takes an array `a[]` of `int` values and an integer M as arguments and returns an array of length M whose i th entry is the number of times the integer i appeared in the argument array. If the values in `a[]` are all between 0 and $M-1$, the sum of the values in the returned array should be equal to `a.length`.

1.1.16 Give the value of `exR1(6)`:

```
public static String exR1(int n)
{
    if (n <= 0) return "";
    return exR1(n-3) + n + exR1(n-2) + n;
}
```

1.1.17 Criticize the following recursive function:

```
public static String exR2(int n)
{
    String s = exR2(n-3) + n + exR2(n-2) + n;
    if (n <= 0) return "";
    return s;
}
```

Answer: The base case will never be reached. A call to `exR2(3)` will result in calls to `exR2(0)`, `exR2(-3)`, `exR3(-6)`, and so forth until a `StackOverflowError` occurs.

1.1.18 Consider the following recursive function:

```
public static int mystery(int a, int b)
{
    if (b == 0) return 0;
    if (b % 2 == 0) return mystery(a+a, b/2);
    return mystery(a+a, b/2) + a;
}
```

What are the values of `mystery(2, 25)` and `mystery(3, 11)`? Given positive integers `a` and `b`, describe what value `mystery(a, b)` computes. Answer the same question, but replace `+` with `*` and replace `return 0` with `return 1`.

1.1.19 Run the following program on your computer:

```
public class Fibonacci
{
    public static long F(int N)
    {
        if (N == 0) return 0;
        if (N == 1) return 1;
        return F(N-1) + F(N-2);
    }

    public static void main(String[] args)
    {
        for (int N = 0; N < 100; N++)
            StdOut.println(N + " " + F(N));
    }
}
```

EXERCISES *(continued)*

What is the largest value of N for which this program takes less 1 hour to compute the value of $F(N)$? Develop a better implementation of $F(N)$ that saves computed values in an array.

1.1.20 Write a recursive static method that computes the value of $\ln(N!)$

1.1.21 Write a program that reads in lines from standard input with each line containing a name and two integers and then uses `printf()` to print a table with a column of the names, the integers, and the result of dividing the first by the second, accurate to three decimal places. You could use a program like this to tabulate batting averages for baseball players or grades for students.

1.1.22 Write a version of `BinarySearch` that uses the recursive `rank()` given on page 25 and *traces* the method calls. Each time the recursive method is called, print the argument values `lo` and `hi`, indented by the depth of the recursion. *Hint:* Add an argument to the recursive method that keeps track of the depth.

1.1.23 Add to the `BinarySearch` test client the ability to respond to a second argument: `+` to print numbers from standard input that *are not* in the whitelist, `-` to print numbers that *are* in the whitelist.

1.1.24 Give the sequence of values of p and q that are computed when Euclid's algorithm is used to compute the greatest common divisor of 105 and 24. Extend the code given on page 4 to develop a program `Euclid` that takes two integers from the command line and computes their greatest common divisor, printing out the two arguments for each call on the recursive method. Use your program to compute the greatest common divisor of 1111111 and 1234567.

1.1.25 Use mathematical induction to prove that Euclid's algorithm computes the greatest common divisor of any pair of nonnegative integers p and q .

CREATIVE PROBLEMS

1.1.26 *Sorting three numbers.* Suppose that the variables `a`, `b`, `c`, and `t` are all of the same numeric primitive type. Show that the following code puts `a`, `b`, and `c` in ascending order:

```
if (a > b) { t = a; a = b; b = t; }
if (a > c) { t = a; a = c; c = t; }
if (b > c) { t = b; b = c; c = t; }
```

1.1.27 *Binomial distribution.* Estimate the number of recursive calls that would be used by the code

```
public static double binomial(int N, int k, double p)
{
    if ((N == 0) || (k < 0)) return 1.0;
    return (1.0 - p)*binomial(N-1, k) + p*binomial(N-1, k-1);
}
```

to compute `binomial(100, 50)`. Develop a better implementation that is based on saving computed values in an array.

1.1.28 *Remove duplicates.* Modify the test client in `BinarySearch` to remove any duplicate keys in the whitelist after the sort.

1.1.29 *Equal keys.* Add to `BinarySearch` a static method `rank()` that takes a key and a sorted array of `int` values (some of which may be equal) as arguments and returns the number of elements that are smaller than the key and a similar method `count()` that returns the number of elements equal to the key. *Note:* If `i` and `j` are the values returned by `rank(key, a)` and `count(key, a)` respectively, then `a[i..i+j-1]` are the values in the array that are equal to key.

1.1.30 *Array exercise.* Write a code fragment that creates an N -by- N boolean array `a[][]` such that `a[i][j]` is `true` if `i` and `j` are relatively prime (have no common factors), and `false` otherwise.

1.1.31 *Random connections.* Write a program that takes as command-line arguments an integer `N` and a `double` value `p` (between 0 and 1), plots N equally spaced dots of size `.05` on the circumference of a circle, and then, with probability `p` for each pair of points, draws a gray line connecting them.

CREATIVE PROBLEMS *(continued)*

1.1.32 Histogram. Suppose that the standard input stream is a sequence of `double` values. Write a program that takes an integer N and two `double` values l and r from the command line and uses `StdDraw` to plot a histogram of the count of the numbers in the standard input stream that fall in each of the N intervals defined by dividing (l, r) into N equal-sized intervals.

1.1.33 Matrix library. Write a library `Matrix` that implements the following API:

```
public class Matrix
{
    static double dot(double[] x, double[] y)           vector dot product
    static double[][] mult(double[][] a, double[][] b) matrix-matrix product
    static double[][] transpose(double[][] a)          transpose
    static double[] mult(double[][] a, double[] x)     matrix-vector product
    static double[] mult(double[] y, double[][] a)     vector-matrix product
}
```

Develop a test client that reads values from standard input and tests all the methods.

1.1.34 Filtering. Which of the following *require* saving all the values from standard input (in an array, say), and which could be implemented as a filter using only a fixed number of variables and arrays of fixed size (not dependent on N)? For each, the input comes from standard input and consists of N real numbers between 0 and 1.

- Print the maximum and minimum numbers.
- Print the median of the numbers.
- Print the k th smallest value, for k less than 100.
- Print the sum of the squares of the numbers.
- Print the average of the N numbers.
- Print the percentage of numbers greater than the average.
- Print the N numbers in increasing order.
- Print the N numbers in random order.

EXPERIMENTS

1.1.35 *Dice simulation.* The following code computes the exact probability distribution for the sum of two dice:

```
int SIDES = 6;
double[] dist = new double[2*SIDES+1];
for (int i = 1; i <= SIDES; i++)
    for (int j = 1; j <= SIDES; j++)
        dist[i+j] += 1.0;

for (int k = 2; k <= 2*SIDES; k++)
    dist[k] /= 36.0;
```

The value `dist[i]` is the probability that the dice sum to `k`. Run experiments to validate this calculation simulating N dice throws, keeping track of the frequencies of occurrence of each value when you compute the sum of two random integers between 1 and 6. How large does N have to be before your empirical results match the exact results to three decimal places?

1.1.36 *Empirical shuffle check.* Run computational experiments to check that our shuffling code on page 32 works as advertised. Write a program `ShuffleTest` that takes command-line arguments M and N , does N shuffles of an array of size M that is initialized with `a[i] = i` before each shuffle, and prints an M -by- M table such that row i gives the number of times i wound up in position j for all j . All entries in the array should be close to N/M .

1.1.37 *Bad shuffling.* Suppose that you choose a random integer between 0 and $N-1$ in our shuffling code instead of one between i and $N-1$. Show that the resulting order is *not* equally likely to be one of the $N!$ possibilities. Run the test of the previous exercise for this version.

1.1.38 *Binary search versus brute-force search.* Write a program `BruteForceSearch` that uses the brute-force search method given on page 48 and compare its running time on your computer with that of `BinarySearch` for `largeW.txt` and `largeT.txt`.

EXPERIMENTS *(continued)*

1.1.39 *Random matches.* Write a `BinarySearch` client that takes an `int` value `T` as command-line argument and runs T trials of the following experiment for $N = 10^3$, 10^4 , 10^5 , and 10^6 : generate two arrays of N randomly generated positive six-digit `int` values, and find the number of values that appear in both arrays. Print a table giving the average value of this quantity over the T trials for each value of N .

This page intentionally left blank



1.2 DATA ABSTRACTION

A DATA TYPE is a set of values and a set of operations on those values. So far, we have discussed in detail Java's *primitive* data types: for example, the *values* of the primitive data type `int` are integers between -2^{31} and $2^{31} - 1$; the *operations* of `int` include `+`, `*`, `-`, `/`, `%`, `<`, and `>`. In principle, we could write all of our programs using only the built-in primitive types, but it is much more convenient to write programs at a higher level of abstraction. In this section, we focus on the process of defining and using data types, which is known as *data abstraction* (and supplements the *function abstraction* style that is the basis of SECTION 1.1).

Programming in Java is largely based on building data types known as *reference types* with the familiar Java `class`. This style of programming is known as *object-oriented programming*, as it revolves around the concept of an *object*, an entity that holds a data type value. With Java's primitive types we are largely confined to programs that operate on numbers, but with reference types we can write programs that operate on strings, pictures, sounds, any of hundreds of other abstractions that are available in Java's standard libraries or on our booksite. Even more significant than libraries of predefined data types is that the range of data types available in Java programming is open-ended, because *you can define your own data types* to implement any abstraction whatsoever.

An *abstract data type* (ADT) is a data type whose representation is hidden from the client. Implementing an ADT as a Java class is not very different from implementing a function library as a set of static methods. The primary difference is that we associate *data* with the function implementations and we hide the representation of the data from the client. When *using* an ADT, we focus on the *operations* specified in the API and pay no attention to the data representation; when *implementing* an ADT, we focus on the *data*, then implement operations on that data.

Abstract data types are important because they support encapsulation in program design. In this book, we use them as a means to

- Precisely specify problems in the form of APIs for use by diverse clients
- Describe algorithms and data structures as API implementations

Our primary reason for studying different algorithms for the same task is that performance characteristics differ. Abstract data types are an appropriate framework for the study of algorithms because they allow us to put knowledge of algorithm performance to immediate use: we can substitute one algorithm for another to improve performance for all clients without changing any client code.

Using abstract data types *You do not need to know how a data type is implemented in order to be able to use it*, so we begin by describing how to write programs that use a simple data type named `Counter` whose values are a name and a nonnegative integer and whose operations are *create and initialize to zero*, *increment by one*, and *examine the current value*. This abstraction is useful in many contexts. For example, it would be reasonable to use such a data type in electronic voting software, to ensure that the only thing that a voter can do is increment a chosen candidate's tally by one. Or, we might use a `Counter` to keep track of fundamental operations when analyzing the performance of algorithms. To use a `Counter`, you need to learn our mechanism for specifying the operations defined in the data type and the Java language mechanisms for creating and manipulating data-type values. Such mechanisms are critically important in modern programming, and we use them throughout this book, so this first example is worthy of careful attention.

API for an abstract data type. To specify the behavior of an abstract data type, we use an *application programming interface* (API), which is a list of *constructors* and *instance methods* (operations), with an informal description of the effect of each, as in this API for `Counter`:

```
public class Counter
    Counter(String id)      create a counter named id
    void increment()       increment the counter by one
    int tally()            number of increments since creation
    String toString()      string representation
```

An API for a counter

Even though the basis of a data-type definition is a set of values, the role of the values is not visible from the API, only the operations on those values. Accordingly, an ADT definition has many similarities with a library of static methods (see page 24):

- Both are implemented as a Java `class`.
- Instance methods may take zero or more arguments of a specified type, separated by commas and enclosed in parentheses.
- They may provide a return value of a specified type or no return value (signified by `void`).

And there are three significant differences:

- Some entries in the API have the same name as the class and lack a return type. Such entries are known as *constructors* and play a special role. In this case, `Counter` has a constructor that takes a `String` argument.

- Instance methods lack the `static` modifier. They are *not* static methods—their purpose is to operate on data type values.
- Some instance methods are present so as to adhere to Java conventions—we refer to such methods as *inherited methods* and shade them gray in the API.

As with APIs for libraries of static methods, an API for an abstract data type is a contract with all clients and, therefore, the starting point both for developing any client code and for developing any data-type implementation. In this case, the API tells us that to use `Counter`, we have available the `Counter()` constructor, the `increment()` and `tally()` instance methods, and the inherited `toString()` method.

Inherited methods. Various Java conventions enable a data type to take advantage of built-in language mechanisms by including specific methods in the API. For example, all Java data types *inherit* a `toString()` method that returns a `String` representation of the data-type values. Java calls this method when any data-type value is to be concatenated with a `String` value with the `+` operator. The default implementation is not particularly useful (it gives a string representation of the memory address of the data-type value), so we often provide an implementation that overrides the default, and include `toString()` in the API whenever we do so. Other examples of such methods include `equals()`, `compareTo()`, and `hashCode()` (see page 101).

Client code. As with modular programming based on static methods, the API allows us to write client code without knowing details of the implementation (and to write implementation code without knowing details of any particular client). The mechanisms introduced on page 28 for organizing programs as independent modules are useful for all Java classes, and thus are effective for modular programming with ADTs as well as for libraries of static methods. Accordingly, we can use an ADT in any program provided that the source code is in a `.java` file in the same directory, or in the standard Java library, or accessible through an `import` statement, or through one of the classpath mechanisms described on the booksite. All of the benefits of modular programming follow. By encapsulating all the code that implements a data type within a single Java class, we enable the development of client code at a higher level of abstraction. To develop client code, you need to be able to *declare variables*, *create objects* to hold data-type values, and *provide access* to the values for instance methods to operate on them. These processes are different from the corresponding processes for primitive types, though you will notice many similarities.

Objects. Naturally, you can declare that a variable `heads` is to be associated with data of type `Counter` with the code

```
Counter heads;
```

but how can you assign values or specify operations? The answer to this question involves a fundamental concept in data abstraction: an *object* is an entity that can take on a data-type value. Objects are characterized by three essential properties: *state*, *identity*, and *behavior*. The *state* of an object is a value from its data type. The *identity* of an object distinguishes one object from another. It is useful to think of an object's identity as the place where its value is stored in memory. The *behavior* of an object is the effect of data-type operations. The implementation has the sole responsibility for maintaining an object's identity, so that client code can use a data type without regard to the representation of its state by conforming to an API that describes an object's behavior. An object's state might be used to provide information to a client or cause a side effect or be changed by one of its data type's operations, but the details of the representation of the data-type value are not relevant to client code. A *reference* is a mechanism for accessing an object. Java nomenclature makes clear the distinction from primitive types (where variables are associated with values) by using the term *reference types* for nonprimitive types. The details of implementing references vary in Java implementations, but it is useful to think of a reference as a memory address, as shown at right (for brevity, we use three-digit memory addresses in the diagram).

Creating objects. Each data-type value is stored in an object. To create (or *instantiate*) an individual object, we invoke a constructor by using the keyword `new`, followed by the class name, followed by `()` (or a list of argument values enclosed in parentheses, if the constructor takes arguments). A constructor has no return type because it always returns a reference to an object of its data type. Each time that a client uses `new()`, the system

- Allocates memory space for the object
- Invokes the constructor to initialize its value
- Returns a reference to the object

In client code we typically create objects in an initializing declaration that associates a variable with the object, as we often do with variables of primitive types. Unlike primitive types, variables are associated with references to objects, not the data-type values

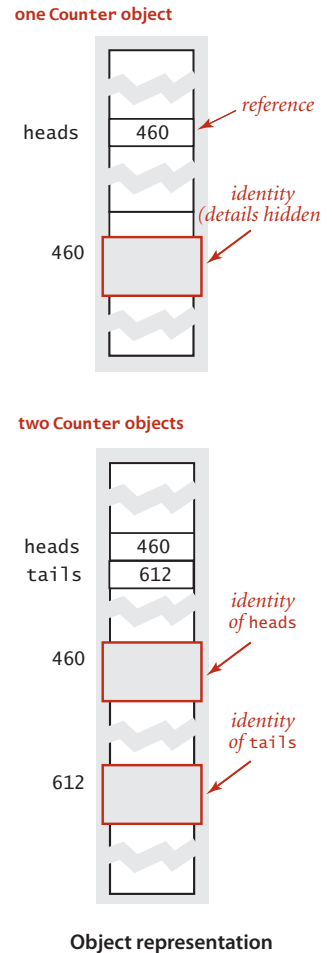

themselves. We can create any number of objects from the same class—each object has its own identity and may or may not store the same value as another object of the same type. For example, the code

```
Counter heads = new Counter("heads");
Counter tails = new Counter("tails");
```

creates two different `Counter` objects. In an abstract data type, details of the representation of the value are hidden from client code. You might assume that the value associated with each `Counter` object is a `String` name and an `int` tally, but *you cannot write code that depends on any specific representation* (or even know whether that assumption is true—perhaps the tally is a `long` value).

Invoking instance methods. The purpose of an instance method is to operate on data-type values, so the Java language includes a special mechanism to invoke instance methods that emphasizes a connection to an object. Specifically, we invoke an instance method

`Counter heads;` ← *declaration*

with *new* (constructor)

```
heads = new Counter ("heads");
```

invoke a constructor (create an object)

as a statement (void return value)

```
heads.increment();
```

object name

invoke an instance method that changes the object's value

as an expression

```
heads.tally() - tails.tally()
```

object name

invoke an instance method that accesses the object's value

via automatic type conversion (`toString()`)

```
StdOut.println( heads );
```

invoke `heads.toString()`

Invoking instance methods

declaration to associate variable with object reference

call on constructor to create an object

```
Counter heads = new Counter("heads");
```

Creating an object

by writing a variable name that refers to an object, followed by a period, followed by an instance method name, followed by 0 or more arguments, enclosed in parentheses and separated by commas. An instance method might *change* the data-type value or just *examine* the data-type value. Instance methods have all of the properties of static methods that we considered on page 24—arguments are passed by value, method names can be overloaded, they may have a return value, and they may cause side effects—but they have an additional property that characterizes them: *each invocation is associated with an object*. For example, the code

```
heads.increment();
```

invokes the instance method `increment()` to operate on the `Counter` object `heads` (in this case the operation involves incrementing the tally), and the code

```
heads.tally() - tails.tally();
```

invokes the instance method `tally()` twice, first to operate on the `Counter` object `heads` and then to operate on the `Counter` object `tails` (in this case the

operation involves returning the tally as an `int` value). As these examples illustrate, you can use calls on instance methods in client code in the same way as you use calls on static methods—as statements (`void` methods) or values in expressions (methods that return a value). The primary purpose of static methods is to implement functions; the primary purpose of non-static (instance) methods is to implement data-type operations. Either type of method may appear in client code, but you can easily distinguish between them, because a static method call starts with a *class* name (uppercase, by convention) and a non-static method call always starts with an *object* name (lowercase, by convention). These differences are summarized in the table at right.

	instance method	static method
<i>sample call</i>	<code>head.increment()</code>	<code>Math.sqrt(2.0)</code>
<i>invoked with</i>	object name	class name
<i>parameters</i>	reference to object and argument(s)	argument(s)
<i>primary purpose</i>	examine or change object value	compute return value

Instance methods versus static methods

Using objects. Declarations give us variable names for objects that we can use in code not just to create objects and invoke instance methods, but also in the same way as we use variable names for integers, floating-point numbers, and other primitive types. To develop client code for a given data type, w:

- Declare variables of the type, for use in referring to objects
- Use the keyword `new` to invoke a constructor that creates objects of the type
- Use the object name to invoke instance methods, either as statements or within expressions

For example, the class `Flips` shown at the top of the next page is a `Counter` client that takes a command-line argument `T` and simulates `T` coin flips (it is also a `StdRandom` client). Beyond these direct uses, we can use variables associated with objects in the same way as we use variables associated with primitive-type values:

- In assignment statements
- To pass or return objects from methods
- To create and use arrays of object.

Understanding the behavior of each of these types of uses requires thinking in terms of *references*, not values, as you will see when we consider them, in turn.

Assignment statements. An assignment statement with a reference type creates a copy of the reference. The assignment statement does not create a new object, just another reference to an existing object. This situation is known as *aliasing*: both variables refer to the same object. The effect of aliasing is a bit unexpected, because it is different for variables holding values of a primitive type. Be sure that you understand the difference.

```

public class Flips
{
    public static void main(String[] args)
    {
        int T = Integer.parseInt(args[0]);
        Counter heads = new Counter("heads");
        Counter tails = new Counter("tails");
        for (int t = 0; t < T; t++)
            if (StdRandom.bernoulli(0.5))
                heads.increment();
            else tails.increment();
        StdOut.println(heads);
        StdOut.println(tails);
        int d = heads.tally() - tails.tally();
        StdOut.println("delta: " + Math.abs(d));
    }
}

```

Counter client that simulates T coin flips

```

% java Flips 10
5 heads
5 tails
delta: 0

% java Flips 10
8 heads
2 tails
delta: 6

% java Flips 1000000
499710 heads
500290 tails
delta: 580

```

If x and y are variables of a primitive type, then the assignment $x = y$ copies the value of y to x . For reference types, the *reference* is copied (not the value). Aliasing is a common source of bugs in Java programs, as illustrated by the following example:

```

Counter c1 = new Counter("ones");
c1.increment();
Counter c2 = c1;
c2.increment();
StdOut.println(c1);

```

With a typical `toString()` implementation this code would print the string "2 ones" which may or may not be what was intended and is counterintuitive at first. Such bugs are common in programs written by people without much experience in using objects (that may be you, so pay attention here!). Changing the state of an object impacts all code involving aliased variables referencing that object. We are used to thinking of two different variables of primitive types as being independent, but that intuition does not carry over to variables of reference types.

```

Counter c1;
c1 = new Counter("ones");
c1.increment();
Counter c2 = c1;
c2.increment();

```

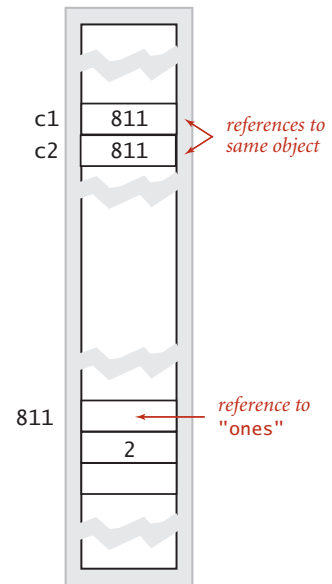

Aliasing

Objects as arguments. You can pass objects as *arguments* to methods. This ability typically simplifies client code. For example, when we use a `Counter` as an argument, we are essentially passing both a name and a tally, but need only specify one variable. When we call a method with arguments, the effect in Java is as if each argument value were to appear on the right-hand side of an assignment statement with the corresponding argument name on the left. That is, Java passes a *copy* of the argument value from the calling program to the method. This arrangement is known as *pass by value* (see page 24). One important consequence is that the method cannot change the value of a caller's variable. For primitive types, this policy is what we expect (the two variables are independent), but each time that we use a reference type as a method argument we create an alias, so we must be cautious. In other words, the convention is to pass the *reference* by value (make a copy of it) but to pass the *object* by reference. For example, if we pass a reference to an object of type `Counter`, the method cannot change the original reference (make it point to a different `Counter`), but it *can* change the value of the object, for example by using the reference to call `increment()`.

Objects as return values. Naturally, you can also use an object as a *return value* from a method. The method might return an object passed to it as an argument, as in the example below, or it might create an object and return a reference to it. This capability is important because Java methods allow only one return value—using objects enables us to write code that, in effect, returns multiple values.

```
% java FlipsMax 1000000
500281 tails wins
```

```
public class FlipsMax
{
    public static Counter max(Counter x, Counter y)
    {
        if (x.tally() > y.tally()) return x;
        else return y;
    }

    public static void main(String[] args)
    {
        int T = Integer.parseInt(args[0]);
        Counter heads = new Counter("heads");
        Counter tails = new Counter("tails");
        for (int t = 0; t < T; t++)
            if (StdRandom.bernoulli(0.5))
                heads.increment();
            else tails.increment();

        if (heads.tally() == tails.tally())
            StdOut.println("Tie");
        else StdOut.println(max(heads, tails) + " wins");
    }
}
```

Example of a static method with object arguments and return values

Arrays are objects. In Java, every value of any nonprimitive type is an object. In particular, arrays are objects. As with strings, there is special language support for certain operations on arrays: declarations, initialization, and indexing. As with any other object, when we pass an array to a method or use an array variable on the right hand side of an assignment statement, we are making a copy of the array reference, not a copy of the array. This convention is appropriate for the typical case where we expect the method to be able to modify the array, by rearranging its entries, as, for example, in `java.util.Arrays.sort()` or the `shuffle()` method that we considered on page 32.

Arrays of objects. Array entries can be of any type, as we have already seen: `args[]` in our `main()` implementations is an array of `String` objects. When we create an array of objects, we do so in two steps:

- Create the array, using the bracket syntax for array constructors.
- Create each object in the array, using a standard constructor for each.

For example, the code below simulates rolling a die, using an array of `Counter` objects to keep track of the number of occurrences of each possible value. An array of objects in Java is an array of references to objects, not the objects themselves. If the objects are large, then we may gain efficiency by not having to move them around, just their references. If they are small, we may lose efficiency by having to follow a reference each time we need to get to some information.

```
public class Rolls
{
    public static void main(String[] args)
    {
        int T = Integer.parseInt(args[0]);
        int SIDES = 6;
        Counter[] rolls = new Counter[SIDES+1];
        for (int i = 1; i <= SIDES; i++)
            rolls[i] = new Counter(i + "'s");

        for (int t = 0; t < T; t++)
        {
            int result = StdRandom.uniform(1, SIDES+1);
            rolls[result].increment();
        }
        for (int i = 1; i <= SIDES; i++)
            StdOut.println(rolls[i]);
    }
}
```

Counter client that simulates T rolls of a die

```
% java Rolls 1000000
167308 1's
166540 2's
166087 3's
167051 4's
166422 5's
166592 6's
```

WITH THIS FOCUS ON OBJECTS, writing code that embraces data abstraction (defining and using data types, with data-type values held in objects) is widely referred to as *object-oriented programming*. The basic concepts that we have just covered are the starting point for object-oriented programming, so it is worthwhile to briefly summarize them. A *data type* is a set of values and a set of operations defined on those values. We implement data types in independent Java `class` modules and write client programs that use them. An *object* is an entity that can take on a data-type value or an *instance* of a data type. Objects are characterized by three essential properties: *state*, *identity*, and *behavior*. A data-type implementation supports clients of the data type as follows:

- Client code can *create objects* (establish identity) by using the `new` construct to invoke a constructor that creates an object, initializes its instance variables, and returns a reference to that object.
- Client code can *manipulate data-type values* (control an object's behavior, possibly changing its state) by using a variable associated with an object to invoke an instance method that operates on that object's instance variables.
- Client code can *manipulate objects* by creating arrays of objects and passing them and returning them to methods, in the same way as for primitive-type values, except that variables refer to references to values, not the values themselves.

These capabilities are the foundation of a flexible, modern, and widely useful programming style that we will use as the basis for studying algorithms in this book.

Examples of abstract data types The Java language has thousands of built-in ADTs, and we have defined many other ADTs to facilitate the study of algorithms. Indeed, every Java program that we write is a data-type implementation (or a library of static methods). To control complexity, we will specifically cite APIs for any ADT that we use in this book (not many, actually).

In this section, we introduce as examples several data types, with some examples of client code. In some cases, we present excerpts of APIs that may contain dozens of instance methods or more. We articulate these APIs to present real-world examples, to specify the instance methods that we will use in the book, and to emphasize that you do not need to know the details of an ADT implementation in order to be able to use it.

For reference, the data types that we use and develop in this book are shown on the facing page. These fall into several different categories:

- Standard system ADTs in `java.lang.*`, which can be used in any Java program.
- Java ADTs in libraries such as `java.awt`, `java.net`, and `java.io`, which can also be used in any Java program, but need an `import` statement.
- Our I/O ADTs that allow us to work with multiple input/output streams similar to `StdIn` and `StdOut`.
- Data-oriented ADTs whose primary purpose is to facilitate organizing and processing data by encapsulating the representation. We describe several examples for applications in computational geometry and information processing later in this section and use them as examples in client code later on.
- Collection ADTs whose primary purpose is to facilitate manipulation collections of data of the same. We describe the basic `Bag`, `Stack`, and `Queue` types in SECTION 1.3, `PQ` types in CHAPTER 2, and the `ST` and `SET` types in CHAPTERS 3 and 5.
- Operations-oriented ADTs that we use to analyze algorithms, as described in SECTION 1.4 and SECTION 1.5.
- ADTs for graph algorithms, including both data-oriented ADTs that focus on encapsulating representations of various kinds of graphs and operations-oriented ADTs that focus on providing specifications for graph-processing algorithms.

This list does not include the dozens of types that we consider in exercises, which may be found in the index. Also, as described on page 90, we often distinguish multiple implementations of various ADTs with a descriptive prefix. As a group, the ADTs that we use demonstrate that organizing and understanding the data types that you use is an important factor in modern programming.

A typical application might use only five to ten of these ADTs. A prime goal in the development and organization of the ADTs in this book is to enable programmers to easily take advantage of a relatively small set of them in developing client code.

standard Java system types in java.lang

Integer	<i>int wrapper</i>
Double	<i>double wrapper</i>
String	<i>indexed chars</i>
StringBuilder	<i>builder for strings</i>

other Java types

java.awt.Color	<i>colors</i>
java.awt.Font	<i>fonts</i>
java.net.URL	<i>URLs</i>
java.io.File	<i>files</i>

our standard I/O types

In	<i>input stream</i>
Out	<i>output stream</i>
Draw	<i>drawing</i>

data-oriented types for client examples

Point2D	<i>point in the plane</i>
Interval1D	<i>1D interval</i>
Interval2D	<i>2D interval</i>
Date	<i>date</i>
Transaction	<i>transaction</i>

types for the analysis of algorithms

Counter	<i>counter</i>
Accumulator	<i>accumulator</i>
VisualAccumulator	<i>visual version</i>
Stopwatch	<i>stopwatch</i>

collection types

Stack	<i>pushdown stack</i>
Queue	<i>FIFO queue</i>
Bag	<i>bag</i>
MinPQ MaxPQ	<i>priority queue</i>
IndexMinPQ IndexMinPQ	<i>priority queue (indexed)</i>
ST	<i>symbol table</i>
SET	<i>set</i>
StringST	<i>symbol table (string keys)</i>

data-oriented graph types

Graph	<i>graph</i>
Digraph	<i>directed graph</i>
Edge	<i>edge (weighted)</i>
EdgeWeightedGraph	<i>graph (weighted)</i>
DirectedEdge	<i>edge (directed, weighted)</i>
EdgeWeightedDigraph	<i>graph (directed, weighted)</i>

operations-oriented graph types

UF	<i>dynamic connectivity</i>
DepthFirstPaths	<i>DFS path searcher</i>
CC	<i>connected components</i>
BreadthFirstPaths	<i>BFS path search</i>
DirectedDFS	<i>DFS digraph path search</i>
DirectedBFS	<i>BFS digraph path search</i>
TransitiveClosure	<i>all paths</i>
Topological	<i>topological order</i>
DepthFirstOrder	<i>DFS order</i>
DirectedCycle	<i>cycle search</i>
SCC	<i>strong components</i>
MST	<i>minimum spanning tree</i>
SP	<i>shortest paths</i>

Selected ADTs used in this book

Geometric objects. A natural example of object-oriented programming is designing data types for geometric objects. For example, the APIs on the facing page define

```
public static void main(String[] args)
{
    double xlo = Double.parseDouble(args[0]);
    double xhi = Double.parseDouble(args[1]);
    double ylo = Double.parseDouble(args[2]);
    double yhi = Double.parseDouble(args[3]);
    int T = Integer.parseInt(args[4]);

    Interval1D x = new Interval1D(xlo, xhi);
    Interval1D y = new Interval1D(ylo, yhi);
    Interval2D box = new Interval2D(x, y);
    box.draw();

    Counter c = new Counter("hits");
    for (int t = 0; t < T; t++)
    {
        double x = Math.random();
        double y = Math.random();
        Point p = new Point(x, y);
        if (box.contains(p)) c.increment();
        else p.draw();
    }

    StdOut.println(c);
    StdOut.println(box.area());
}
```

Interval2D test client

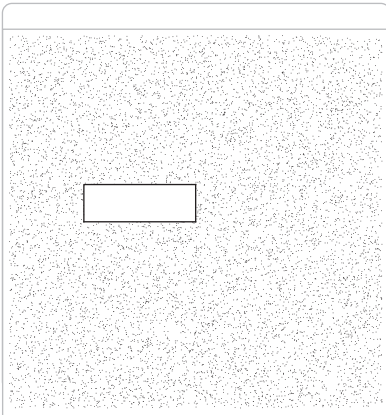

```
% java Interval2D .2 .5 .5 .6 10000
297 hits
.03
```

abstract data types for three familiar geometric objects: `Point2D` (points in the plane), `Interval1D` (intervals on the line), and `Interval2D` (two-dimensional intervals in the plane, or axis-aligned rectangles). As usual, the APIs are essentially self-documenting and lead immediately to easily understood client code such as the example at left, which reads the boundaries of an `Interval2D` and an integer `T` from the command line, generates `T` random points in the unit square, and counts the number of points that fall in the interval (an estimate of the area of the rectangle). For dramatic effect, the client also draws the interval and the points that fall outside the interval. This computation is a model for a method that reduces the problem of computing the area and volume of geometric shapes to the problem of determining whether a point falls

within the shape or not (a less difficult but not trivial problem). Of course, we can define APIs for other geometric objects such as line segments, triangles, polygons, circles, and so forth, though implementing operations on them can be challenging. Several examples are addressed in the exercises at the end of this section.

PROGRAMS THAT PROCESS GEOMETRIC OBJECTS have wide application in computing with models of the natural world, in scientific computing, video games, movies, and many other applications. The development and study of such programs and applications has blossomed into a far-reaching field of study known as *computational geometry*, which is a

```
public class Point2D
```

```

    Point2D(double x, double y)    create a point
double x()                       x coordinate
double y()                       y coordinate
double r()                       radius (polar coordinates)
double theta()                  angle (polar coordinates)
double distTo(Point2D that)     Euclidean distance from this point to that
void draw()                    draw the point on StdDraw

```

An API for points in the plane

```
public class Interval1D
```

```

    Interval1D(double lo, double hi)    create an interval
double length()                       length of the interval
boolean contains(double x)            does the interval contain x?
boolean intersects(Interval1D that)   does the interval intersect that?
void draw()                          draw the interval on StdDraw

```

An API for intervals on the line

```
public class Interval2D
```

```

    Interval2D(Interval1D x, Interval1D y)    create a 2D interval
double area()                               area of the 2D interval
boolean contains(Point p)                  does the 2D interval contain p?
boolean intersects(Interval2D that)       does the 2D interval intersect that?
void draw()                              draw the 2D interval on StdDraw

```

An API for two dimensional intervals in the plane

fertile area of examples for the application of the algorithms that we address in this book, as you will see in examples throughout the book. In the present context, our interest is to suggest that abstract data types that directly represent geometric abstractions are not difficult to define and can lead to simple and clear client code. This idea is reinforced in several exercises at the end of this section and on the booksite.

Information processing Whether it be a bank processing millions of credit card transactions or a web analytics company processing billions of touchpad taps or a scientific research group processing millions of experimental observations, a great many applications are centered around processing and organizing information. Abstract data types provide a natural mechanism for organizing the information. Without getting into details, the two APIs on the facing page suggest a typical approach for a commercial application. The idea is to define data types that allow us to keep information in objects that correspond to things in the real world. A date is a day, a month, and a year and a transaction is a customer, a date, and an amount. These two are just examples: we might also define data types that can hold detailed information for customers, times, locations, goods and services, or whatever. Each data type consists of constructors that create objects containing the data and methods for use by client code to access it. To simplify client code, we provide two constructors for each type, one that presents the data in its appropriate type and another that parses a string to get the data (see EXERCISE 1.2.19 for details). As usual, there is no reason for client code to know the representation of the data. Most often, the reason to organize the data in this way is to treat the data associated with an object as a single entity: we can maintain arrays of `Transaction` values, use `Date` values as a argument or a return value for a method, and so forth. The focus of such data types is on encapsulating the data, while at the same time enabling the development of client code that does not depend on the representation of the data. We do not dwell on organizing information in this way, except to take note that doing so and including the inherited methods `toString()`, `compareTo()`, `equals()`, and `hashCode()` allows us to take advantage of algorithm implementations that can process *any type of data*. We will discuss inherited methods in more detail on page 100. For example, we have already noted Java's convention that enables clients to print a string representation of every value if we include `toString()` implementation in a data type. We consider conventions corresponding to the other inherited methods in SECTION 1.3, SECTION 2.5, SECTION 3.4, and SECTION 3.5, using `Date` and `Transaction` as examples. SECTION 1.3 gives classic examples of data types and a Java language mechanism known as *parameterized types*, or *generics*, that takes advantage of these conventions, and CHAPTER 2 and CHAPTER 3 are also devoted to taking advantage of generic types and inherited methods to develop implementations of sorting and searching algorithms that are effective for any type of data.

WHENEVER YOU HAVE DATA OF DIFFERENT TYPES that logically belong together, it is worthwhile to contemplate defining an ADT as in these examples. The ability to do so helps to organize the data, can greatly simplify client code in typical applications, and is an important step on the road to data abstraction.

```
public class Date implements Comparable<Date>
```

```
    Date(int month, int day, int year) create a date
    Date(String date) create a date (parse constructor)
    int month() month
    int day() day
    int year() year
    String toString() string representation
    boolean equals(Object that) is this the same date as that?
    int compareTo(Date that) compare this date to that
    int hashCode() hash code
```

```
public class Transaction implements Comparable<Transaction>
```

```
    Transaction(String who, Date when, double amount)
    Transaction(String transaction) create a transaction (parse constructor)
    String who() customer name
    Date when() date
    double amount() amount
    String toString() string representation
    boolean equals(Object that) is this the same transaction as that?
    int compareTo(Transaction that) compare this transaction to that
    int hashCode() hash code
```

Sample APIs for commercial applications (dates and transactions)

Strings. Java's `String` is an important and useful ADT. A `String` is an indexed sequence of `char` values. `String` has dozens of instance methods, including the following:

```
public class String
```

<code>String()</code>	<i>create an empty string</i>
<code>int length()</code>	<i>length of the string</i>
<code>int charAt(int i)</code>	<i>ith character</i>
<code>int indexOf(String p)</code>	<i>first occurrence of p (-1 if none)</i>
<code>int indexOf(String p, int i)</code>	<i>first occurrence of p after i (-1 if none)</i>
<code>String concat(String t)</code>	<i>this string with t appended</i>
<code>String substring(int i, int j)</code>	<i>substring of this string (ith to j-1st chars)</i>
<code>String[] split(String delim)</code>	<i>strings between occurrences of delim</i>
<code>int compareTo(String t)</code>	<i>string comparison</i>
<code>boolean equals(String t)</code>	<i>is this string's value the same as t's?</i>
<code>int hashCode()</code>	<i>hash code</i>

Java String API (partial list of methods)

`String` values are similar to arrays of characters, but the two are not the same. Arrays have built-in Java language syntax for accessing a character; `String` has instance methods for indexed access, `length`, and many other operations. On the other hand, `String` has special language support for initialization and concatenation: instead of creating and initializing a string with a constructor, we can use a string literal; instead of invoking the method `concat()` we can use the `+` operator. We do not need to consider the details of the implementation, though understanding performance characteristics of some of the methods is important when developing string-processing algorithms, as you will see in CHAPTER 5. Why not just use arrays of characters instead of `String` values? The answer to this question is the same as for any ADT: *to simplify and clarify client code*. With `String`, we can write clear and simple client code that uses numerous convenient instance methods without regard to the way in which strings are represented (see facing page). Even this short list contains powerful operations that require advanced algorithms such

```
String a = "now is ";
String b = "the time ";
String c = "to"
```

<i>call</i>	<i>value</i>
<code>a.length()</code>	7
<code>a.charAt(4)</code>	i
<code>a.concat(c)</code>	"now is to"
<code>a.indexOf("is")</code>	4
<code>a.substring(2, 5)</code>	"w i"
<code>a.split(" ")[0]</code>	"now"
<code>a.split(" ")[1]</code>	"is"
<code>b.equals(c)</code>	false

Examples of string operations

task	implementation
<i>is the string a palindrome?</i>	<pre> public static boolean isPalindrome(String s) { int N = s.length(); for (int i = 0; i < N/2; i++) if (s.charAt(i) != s.charAt(N-1-i)) return false; return true; } </pre>
<i>extract file name and extension from a command-line argument</i>	<pre> String s = args[0]; int dot = s.rank("."); String base = s.substring(0, dot); String extension = s.substring(dot + 1, s.length()); </pre>
<i>print all lines in standard input that contain a string specified on the command line</i>	<pre> String query = args[0]; while (!StdIn.isEmpty()) { String s = StdIn.readLine(); if (s.contains(query)) StdOut.println(s); } </pre>
<i>create an array of the strings on StdIn delimited by whitespace</i>	<pre> String input = StdIn.readAll(); String[] words = input.split("\\s+"); </pre>
<i>check whether an array of strings is in alphabetical order</i>	<pre> public boolean isSorted(String[] a) { for (int i = 1; i < a.length; i++) { if (a[i-1].compareTo(a[i]) > 0) return false; } return true; } </pre>

Typical string-processing code

as those considered in CHAPTER 5. For example, the argument of `split()` can be a *regular expression* (see SECTION 5.4)—the `split()` example on page 81 uses the argument `"\\s+"`, which means “one or more tabs, spaces, newlines, or returns.”

Input and output revisited. A disadvantage of the `StdIn`, `StdOut`, and `StdDraw` standard libraries of SECTION 1.1 is that they restrict us to working with just one input file, one output file, and one drawing for any given program. With object-oriented programming, we can define similar mechanisms that allow us to work with *multiple* input streams, output streams, and drawings within one program. Specifically, our standard library includes the data types `In`, `Out`, and `Draw` with the APIs shown on the facing page. When invoked with a constructor having a `String` argument, `In` and `Out` will first try to find a file in the current directory of your computer that has that name. If it cannot

do so, it will assume the argument to be a website name and will try to connect to that website (if no such website exists, it will issue a runtime exception). In either case, the specified file or website becomes the source/target of the input/output for the stream object thus created, and the `read*()` and `print*()` methods will refer to that file or website. (If you use the no-argument constructor, then you obtain the standard streams.) This arrangement makes it possible for a single program to process

```
public class Cat
{
    public static void main(String[] args)
    { // Copy input files to out (last argument).
      Out out = new Out(args[args.length-1]);
      for (int i = 0; i < args.length - 1; i++)
      { // Copy input file named on ith arg to out.
        In in = new In(args[i]);
        String s = in.readAll();
        out.println(s);
        in.close();
      }
      out.close();
    }
}
```

A sample `In` and `Out` client

```
% more in1.txt
This is

% more in2.txt
a tiny
test.

% java Cat in1.txt in2.txt out.txt

% more out.txt
This is
a tiny
test.
```

multiple files and drawings. You also can assign such objects to variables, pass them as arguments or return values from methods, create arrays of them, and manipulate them just as you manipulate objects of any type. The program `Cat` shown at left is a sample client of `In` and `Out` that uses multiple input streams to concatenate several input files into a single output file. The `In` and `Out` classes also contain static methods for reading files containing values that are all `int`, `double`, or `String` types into an array (see page 126 and EXERCISE 1.2.15).

```
public class In
```

```

    In()                create an input stream from standard input
    In(String name)    create an input stream from a file or website
    boolean isEmpty()  true if no more input, false otherwise
    int readInt()      read a value of type int
    double readDouble() read a value of type double
    ...
    void close()       close the input stream

```

Note: all operations supported by StdIn are also supported for In objects.

API for our data type for input streams

```
public class Out
```

```

    Out()                create an output stream to standard output
    Out(String name)    create an output stream to a file
    void print(String s) append s to the output stream
    void println(String s) append s and a newline to the output stream
    void println()      append a newline to the output stream
    void printf(String f, ...) formatted print to the output stream
    void close()        close the output stream

```

Note: all operations supported by StdOut are also supported for Out objects.

API for our data type for output streams

```
public class Draw
```

```

    Draw()
    void line(double x0, double y0, double x1, double y1)
    void point(double x, double y)
    ...

```

Note: all operations supported by StdDraw are also supported for Draw objects.

API for our data type for drawings

Implementing an abstract data type. As with libraries of static methods, we implement ADTs with a Java `class`, putting the code in a file with the same name as the class, followed by the `.java` extension. The first statements in the file declare *instance variables* that define the data-type values. Following the instance variables are the *constructor* and the *instance methods* that implement operations on data-type values. Instance methods may be *public* (specified in the API) or *private* (used to organize the computation and not available to clients). A data-type definition may have multiple constructors and may also include definitions of static methods. In particular, a unit-test client `main()` is normally useful for testing and debugging. As a first example, we consider an implementation of the Counter ADT that we defined on page 65. A full annotated implementation is shown on the facing page, for reference as we discuss its constituent parts. Every ADT implementation that you will develop has the same basic ingredients as this simple example.

Instance variables. To define data-type values (the *state* of each object), we declare *instance variables* in much the same way as we declare local variables. There is a critical distinction between instance variables and the local variables within a static method or a block that you are accustomed to: there is just *one* value corresponding to each local variable at a given time, but there are *numerous* values corresponding to each instance variable (one for each object that is an instance of the data type). There is no ambiguity with this arrangement, because each time that we access an instance variable, we do so with an object name—that object is the one whose value we are accessing. Also, each declaration is qualified by a *visibility modifier*. In ADT implementations, we use `private`, using a Java language mechanism to enforce the idea that the representation of an ADT is to be hidden from the client, and also `final`, if the value is not to be changed once it is initialized. Counter has two instance variables: a `String` value `name` and an `int` value `count`. If we were to use `public` instance variables (allowed in Java) the data type would, by definition, not be abstract, so we do not do so.

```
public class Counter
{
    private final String name;
    private int count;
    ...
}
```

instance variable declarations

Instance variables in ADTs are private

Constructors. Every Java class has at least one *constructor* that establishes an object's *identity*. A constructor is like a static method, but it can refer directly to instance variables and has no return value. Generally, the purpose of a constructor is to initialize the instance variables. Every constructor creates an object and provides to the client a reference to that object. Constructors always share the same name as the class. We can overload the name and have multiple constructors with different signatures, just as with methods. If no other constructor is defined, a default no-argument constructor is

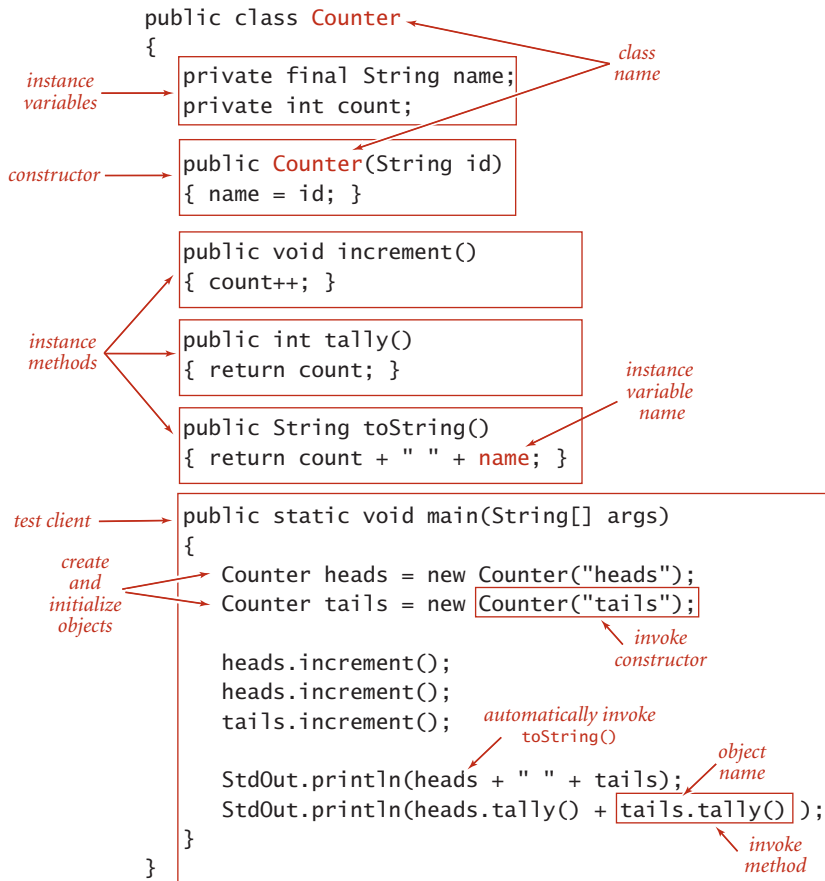

Anatomy of a class that defines a data type

implicit, has no arguments, and initializes instance values to default values. The default values of instance variables are 0 for primitive numeric types, false for boolean, and null for reference types. These defaults may be changed by using initializing declarations for instance variables. Java automatically invokes a constructor when a client program uses the keyword new. Overloaded constructors are typically used to initialize instance variables to client-supplied values other than the defaults. For example, Counter has a one-argument constructor that initializes the name instance variable to the value given as argument (leaving the count instance variable to be initialized to the default value 0).

```
public class Counter
{
    private final String name;
    private int count;
    ...

```

```

    { name = id; }
    ...
}

```

Anatomy of a constructor

Instance methods. To implement data-type instance methods (the *behavior* of each object), we implement *instance methods* with code that is precisely like the code that you learned in SECTION 1.1 to implement static methods (functions). Each instance method has a return type, a *signature* (which specifies its name and the types and names of its parameter variables), and a *body* (which consists of a sequence of statements, including a *return* statement that provides a value of the return type back to the client). When a client invokes a method, the parameter values (if any) are initialized with client values, the statements are executed until a return value is computed, and the value is returned to the client, with the same effect as if the method invocation in the client were replaced with that value. All of this action is the same as for static methods, but there is one critical distinction for instance methods: *they can access and perform operations on instance variables*. How do we specify which object's instance variables we want to use? If you think about this question for a moment, you will see the logical answer: a reference to a variable in an instance method refers to the value *for the object that was used to invoke the method*. When we say heads.increment() the code in increment() is referring to the instance variables for heads. In other words,

```
public void increment()
{ count++; }

```

Anatomy of an instance method

object-oriented programming adds one critically important additional way to use variables in a Java program:

- to invoke an instance method that operates on the object's values.

The difference from working solely with static methods is semantic (see the Q&A), but has reoriented the way that modern programmers think about developing code in many situations. As you will see, it also dovetails well with the study of algorithms and data structures.

Scope. In summary, the Java code that we write to implement instance methods uses *three* kinds of variables:

- Parameter variables
- Local variables
- *Instance variables*

The first two of these are the same as for static methods: parameter variables are specified in the method signature and initialized with client values when the method is called, and local variables are declared and initialized within the method body. The scope of parameter variables is the entire method; the scope of local variables is the following statements in the block where they are defined. Instance variables are completely different: they hold data-type values for objects in a class, and their scope is the entire class (whenever there is an ambiguity, you can use the `this` prefix to identify instance variables). Understanding the distinctions among these three kinds of variables in instance methods is a key to success in object-oriented programming.

```

public class Example
{
    private int var;
    ...

    private void method1()
    {
        int var;
        ... var
        ... this.var
    }

    private void method2()
    {
        ... var
    }
    ...
}

```

instance variable (points to `private int var;`)

local variable (points to `int var;` inside `method1()`)

refers to local variable, NOT instance variable (points to `var` inside `method1()`)

refers to instance variable (points to `this.var` inside `method1()`)

refers to instance variable (points to `var` inside `method2()`)

Scope of instance and local variables in an instance method

API, clients, and implementations. These are the basic components that you need to understand to be able to build and use abstract data types in Java. Every ADT implementation that we will consider will be a Java class with private instance variables, constructors, instance methods, and a client. To fully understand a data type, we need the API, typical client code, and an implementation, summarized for Counter on the facing page. To emphasize the separation of client and implementation, we normally present each client as a separate class containing a static method `main()` and reserve test client's `main()` in the data-type definition for minimal unit testing and development (calling each instance method at least once). In each data type that we develop, we go through the same steps. Rather than thinking about what action we need to take next to accomplish a computational goal (as we did when first learning to program), we think about the needs of a client, then accommodate them in an ADT, following these three steps:

- Specify an API. The purpose of the API is to *separate clients from implementations*, to enable modular programming. We have two goals when specifying an API. First, we want to enable clear and correct client code. Indeed, it is a good idea to write some client code before finalizing the API to gain confidence that the specified data-type operations are the ones that clients need. Second, we want to be able to implement the operations. There is no point specifying operations that we have no idea how to implement.
- Implement a Java class that meets the API specifications. First we choose the instance variables, then we write constructors and the instance methods.
- Develop multiple test clients, to validate the design decisions made in the first two steps.

What operations do clients need to perform, and what data-type values can best support those operations? These basic decisions are at the heart of every implementation that we develop.

API `public class Counter`

<code>Counter(String id)</code>	<i>create a counter named id</i>
<code>void increment()</code>	<i>increment the counter</i>
<code>int tally()</code>	<i>number of increments since creation</i>
<code>String toString()</code>	<i>string representation</i>

typical client

```
public class Flips
{
    public static void main(String[] args)
    {
        int T = Integer.parseInt(args[0]);
        Counter heads = new Counter("heads");
        Counter tails = new Counter("tails");

        for (int t = 0; t < T; t++)
            if (StdRandom.bernoulli(0.5))
                heads.increment();
            else tails.increment();

        StdOut.println(heads);
        StdOut.println(tails);
        int d = heads.tally() - tails.tally();
        StdOut.println("delta: " + Math.abs(d));
    }
}
```

implementation

```
public class Counter
{
    private final String name;
    private int count;

    public Counter(String id)
    { name = id; }

    public void increment()
    { count++; }

    public int tally()
    { return count; }

    public String toString()
    { return count + " " + name; }
}
```

application

```
% java Flips 1000000
500172 heads
499828 tails
delta: 344
```

An abstract data type for a simple counter

More ADT implementations As with any programming concept, the best way to understand the power and utility of ADTs is to consider carefully more examples and more implementations. There will be ample opportunity for you to do so, as much of this book is devoted to ADT implementations, but a few more simple examples will help us lay the groundwork for addressing them.

Date. Shown on the facing page are two implementations of the Date ADT that we considered on page 79. To reduce clutter, we omit the parsing constructor (which is described in EXERCISE 1.2.19) and the inherited methods `equals()` (see page 103), `compareTo()` (see page 247), and `hashCode()` (see EXERCISE 3.4.22). The straightforward implementation on the left maintains the day, month, and year as instance variables, so that the instance methods can just return the appropriate value; the more space-efficient implementation on the right uses only a single `int` value to represent a date, using a mixed-radix number that represents the date with day d , month m , and year y as $512y + 32m + d$. One way that a client might notice the difference between these implementations is by violating implicit assumptions: the second implementation depends for its correctness on the day being between 0 and 31, the month being between 0 and 15, and the year being positive (in practice, both implementations should check that months are between 1 and 12, days are between 1 and 31, and that dates such as June 31 and February 29, 2009, are illegal, though that requires a bit more work). This example highlights the idea that we rarely *fully* specify implementation requirements in an API (we normally do the best we can, and could do better here). Another way that a client might notice the difference between the two implementations is *performance*: the implementation on the right uses less space to hold data-type values at the cost of more time to provide them to the client in the agreed form (one or two arithmetic operations are needed). Such tradeoffs are common: one client may prefer one of the implementations and another client might prefer the other, so we need to accommodate both. Indeed, one of the recurring themes of this book is that we need to understand the space and time requirements of various implementations and their suitability for use by various clients. One of the key advantages of using data abstraction in our implementations is that we can normally change from one implementation to another *without changing any client code*.

Maintaining multiple implementations. Multiple implementations of the same API can present maintainence and nomenclature issues. In some cases, we simply want to replace an old implementation with an improved one. In others, we may need to maintain two implementations, one suitable for some clients, the other suitable for others. Indeed, a prime goal of this book is to consider in depth several implementations of each of a number of fundamental ADTs, generally with different performance characteristics. In this book, we often compare the performance of a single client using two

API	<code>public class Date</code>	
	<code> Date(int month, int day, int year)</code>	<i>create a date</i>
	<code> int month()</code>	<i>month</i>
	<code> int day()</code>	<i>day</i>
	<code> int year()</code>	<i>year</i>
	<code> String toString()</code>	<i>string representation</i>

test client

```
public static void main(String[] args)
{
    int m = Integer.parseInt(args[0]);
    int d = Integer.parseInt(args[1]);
    int y = Integer.parseInt(args[2]);
    Date date = new Date(m, d, y);
    StdOut.println(date);
}
```

application

```
% java Date 12 31 1999
12/31/1999
```

implementation

```
public class Date
{
    private final int month;
    private final int day;
    private final int year;

    public Date(int m, int d, int y)
    { month = m; day = d; year = y; }

    public int month()
    { return month; }

    public int day()
    { return day; }

    public int year()
    { return year; }

    public String toString()
    { return month() + "/" + day()
      + "/" + year(); }
}
```

alternate implementation

```
public class Date
{
    private final int value;

    public Date(int m, int d, int y)
    { value = y*512 + m*32 + d; }

    public int month()
    { return (value / 32) % 16; }

    public int day()
    { return value % 32; }

    public int year()
    { return value / 512; }

    public String toString()
    { return month() + "/" + day()
      + "/" + year(); }
}
```

An abstract data type to encapsulate dates, with two implementations

different implementations of the same API. For this reason, we generally adopt an informal naming convention where we:

- Identify different implementations of the same API by prepending a descriptive modifier. For example, we might name our `Date` implementations on the previous page `BasicDate` and `SmallDate`, and we might wish to develop a `SmartDate` implementation that can validate that dates are legal.
- Maintain a reference implementation with no prefix that makes a choice that should be suitable for most clients. That is, most clients should just use `Date`.

In a large system, this solution is not ideal, as it might involve changing client code. For example, if we were to develop a new implementation `ExtraSmallDate`, then our only options are to change client code or to make it the reference implementation for use by all clients. Java has various advanced language mechanisms for maintaining multiple implementations without needing to change client code, but we use them sparingly because their use is challenging (and even controversial) even for experts, especially in conjunction with other advanced language features that we do value (generics and iterators). These issues are important (for example, ignoring them led to the celebrated *Y2K problem* at the turn of the millennium, because many programs used their own implementations of the date abstraction that did not take into account the first two digits of the year), but detailed consideration of these issues would take us rather far afield from the study of algorithms.

Accumulator. The *accumulator* API shown on the facing page defines an abstract data type that provides to clients the ability to maintain a running average of data values. For example, we use this data type frequently in this book to process experimental results (see SECTION 1.4). The implementation is straightforward: it maintains a `int` instance variable counts the number of data values seen so far and a `double` instance variable that keeps track of the sum of the values seen so far; to compute the average it divides the sum by the count. Note that the implementation does not save the data values—it could be used for a huge number of them (even on a device that is not capable of holding that many), or a huge number of accumulators could be used on a big system. This performance characteristic is subtle and might be specified in the API, because an implementation that does save the values might cause an application to run out of memory.

API	<pre>public class Accumulator { Accumulator() void addDataValue(double val) double mean() String toString() }</pre>	<hr/> <p><i>create an accumulator</i></p> <p><i>add a new data value</i></p> <p><i>mean of all data values</i></p> <p><i>string representation</i></p>
------------	---	--

typical client

```
public class TestAccumulator
{
    public static void main(String[] args)
    {
        int T = Integer.parseInt(args[0]);
        Accumulator a = new Accumulator();
        for (int t = 0; t < T; t++)
            a.addDataValue(StdRandom.random());
        StdOut.println(a);
    }
}
```

application

```
% java TestAccumulator 1000
Mean (1000 values): 0.51829

% java TestAccumulator 1000000
Mean (1000000 values): 0.49948

% java TestAccumulator 1000000
Mean (1000000 values): 0.50014
```

implementation

```
public class Accumulator
{
    private double total;
    private int N;

    public void addDataValue(double val)
    {
        N++;
        total += val;
    }

    public double mean()
    { return total/N; }

    public String toString()
    { return "Mean (" + N + " values): "
        + String.format("%7.5f", mean()); }
}
```

An abstract data type for accumulating data values

Visual accumulator. The *visual accumulator* implementation shown on the facing page extends `Accumulator` to present a useful side effect: it draws on `StdDraw` all the data (in gray) and the running average (in red). The easiest way to do so is to add a constructor that provides the number of points to be plotted and the maximum value, for rescaling the plot. `VisualAccumulator` is not technically an implementation of the `Accumulator` API (its constructor has a different signature and it causes a different prescribed side effect). Generally, we are careful to fully specify APIs and are loath to make *any* changes in an API once articulated, as it might involve changing an unknown amount of client (and implementation) code, but adding a constructor to gain functionality can sometimes be defended because it involves changing the same line in client code that we change when changing a class name. In this example, if we have developed a client that uses an `Accumulator` and perhaps has many calls to `addDataValue()` and `avg()`, we can enjoy the benefits of `VisualAccumulator` by just changing one line of client code.

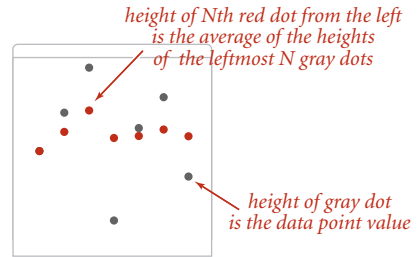

Visual accumulator plot

application

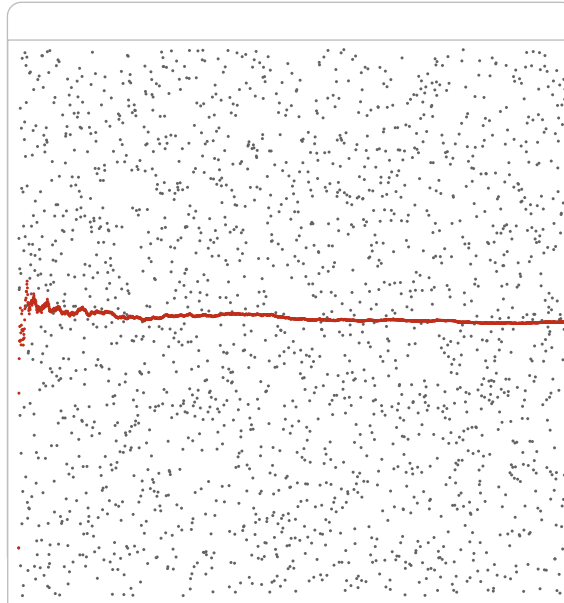

```
% java TestVisualAccumulator 2000
Mean (2000 values): 0.509789
```

API `public class VisualAccumulator`

<code>VisualAccumulator(int trials, double max)</code>	
<code>void addDataValue(double val)</code>	<i>add a new data value</i>
<code>double avg()</code>	<i>average of all data values</i>
<code>String toString()</code>	<i>string representation</i>

typical client

```
public class TestVisualAccumulator
{
    public static void main(String[] args)
    {
        int T = Integer.parseInt(args[0]);
        VisualAccumulator a = new VisualAccumulator(T, 1.0);
        for (int t = 0; t < T; t++)
            a.addDataValue(StdRandom.random());
        StdOut.println(a);
    }
}
```

implementation

```
public class VisualAccumulator
{
    private double total;
    private int N;

    public VisualAccumulator(int trials, double max)
    {
        StdDraw.setXscale(0, trials);
        StdDraw.setYscale(0, max);
        StdDraw.setPenRadius(.005);
    }

    public void addDataValue(double val)
    {
        N++;
        total += val;
        StdDraw.setPenColor(StdDraw.DARK_GRAY);
        StdDraw.point(N, val);
        StdDraw.setPenColor(StdDraw.RED);
        StdDraw.point(N, total/N);
    }

    public double mean()
    public String toString()
    // Same as Accumulator.
}
}
```

An abstract data type for accumulating data values (visual version)

Data-type design *An abstract data type is a data type whose representation is hidden from the client.* This idea has had a powerful effect on modern programming. The various examples that we have considered give us the vocabulary to address advanced characteristics of ADTs and their implementation as Java classes. Many of these topics are, on the surface, tangential to the study of algorithms, so it is safe for you to skim this section and refer to it later in the context of specific implementation problems. Our goal is to put important information related to designing data types in one place for reference and to set the stage for implementations throughout this book.

Encapsulation. A hallmark of object-oriented programming is that it enables us to *encapsulate* data types within their implementations, to facilitate separate development of clients and data type implementations. Encapsulation enables modular programming, allowing us to

- Independently develop of client and implementation code
- Substitute improved implementations without affecting clients
- Support programs not yet written (the API is a guide for any future client)

Encapsulation also isolates data-type operations, which leads to the possibility of

- Limiting the potential for error
- Adding consistency checks and other debugging tools in implementations
- Clarifying client code

An encapsulated data type can be used by any client, so it extends the Java language. The programming style that we are advocating is predicated on the idea of breaking large programs into small modules that can be developed and debugged independently. This approach improves the resiliency of our software by limiting and localizing the effects of making changes, and it promotes code reuse by making it possible to substitute new implementations of a data type to improve performance, accuracy, or memory footprint. The same idea works in many settings. We often reap the benefits of encapsulation when we use system libraries. New versions of the Java system often include new implementations of various data types or static method libraries, but *the APIs do not change*. In the context of the study of algorithms and data structures, there is strong and constant motivation to develop better algorithms because we can improve performance for *all* clients by substituting an improved ADT implementation without changing the code of *any* client. The key to success in modular programming is to maintain *independence* among modules. We do so by insisting on the API being the *only* point of dependence between client and implementation. *You do not need to know how a data type is implemented in order to use it and you can assume that a client knows nothing but the API* when implementing a data type. Encapsulation is the key to attaining both of these advantages.

Designing APIs. One of the most important and most challenging steps in building modern software is designing APIs. This task takes practice, careful deliberation, and many iterations, but any time spent designing a good API is certain to be repaid in time saved debugging or code reuse. Articulating an API might seem to be overkill when writing a small program, but you should consider writing *every* program as though you will need to reuse the code someday. Ideally, an API would clearly articulate behavior for all possible inputs, including side effects, and then we would have software to check that implementations meet the specification. Unfortunately, a fundamental result from theoretical computer science known as the *specification problem* implies that this goal is actually *impossible* to achieve. Briefly, such a specification would have to be written in a formal language like a programming language, and the problem of determining whether two programs perform the same computation is known, mathematically, to be *undecidable*. Therefore, our APIs are brief English-language descriptions of the set of values in the associated abstract data type along with a list of constructors and instance methods, again with brief English-language descriptions of their purpose, including side effects. To validate the design, we always include examples of client code in the text surrounding our APIs. Within this broad outline, there are numerous pitfalls that every API design is susceptible to:

- An API may be *too hard to implement*, implying implementations that are difficult or impossible to develop.
- An API may be *too hard to use*, leading to client code that is more complicated than it would be without the API.
- An API may be *too narrow*, omitting methods that clients need.
- An API may be *too wide*, including a large number of methods not needed by any client. This pitfall is perhaps the most common, and one of the most difficult to avoid. The size of an API tends to grow over time because it is not difficult to add methods to an existing API, but it *is* difficult to remove methods without breaking existing clients.
- An API may be *too general*, providing no useful abstractions.
- An API may be *too specific*, providing abstractions so detailed or so diffuse as to be useless.
- An API may be *too dependent on a particular representation*, therefore not serving the purpose of freeing client code from the details of using that representation. This pitfall is also difficult to avoid, because the representation is certainly central to the development of the implementation.

These considerations are sometimes summarized in yet another motto: *provide to clients the methods they need and no others.*

Algorithms and abstract data types. Data abstraction is naturally suited to the study of algorithms, because it helps us provide a framework within which we can precisely specify both what an algorithm needs to accomplish and how a client can make use of an algorithm. Typically, in this book, an algorithm is an implementation of an instance method in an abstract data type. For example, our whitelisting example at the beginning of the chapter is naturally cast as an ADT client, based on the following operations:

- Construct a SET from an array of given values.
- Determine whether a given value is in the set.

These operations are encapsulated in the `StaticSETofInts` ADT, shown on the facing page along with `Whitelist`, a typical client. `StaticSETofInts` is a special case of the more general and more useful *symbol table* ADT that is the focus of CHAPTER 3. Binary search is one of several algorithms that we study that is suitable for implementing these ADTs. By comparison with the `BinarySearch` implementation on page 47, this implementation leads to clearer and more useful client code. For example, `StaticSETofInts` enforces the idea that the array must be sorted before `rank()` is called. With the abstract data type, we separate the client from the implementation making it easier for *any* client to benefit from the ingenuity of the binary search algorithm, just by following the API (clients of `rank()` in `BinarySearch` have to know to sort the array first). Whitelisting is one of many clients that can take advantage of binary search.

EVERY JAVA PROGRAM is a set of static methods and/or a data type implementation. In this book, we focus primarily on *abstract* data type implementations such as `StaticSETofInts`, where the focus is on operations and the representation of the data is hidden from the client. As this example illustrates, data abstraction enables us to

- Precisely specify what algorithms can provide for clients
- Separate algorithm implementations from the client code
- Develop layers of abstraction, where we make use of well-understood algorithms to develop other algorithms

These are desirable properties of *any* approach to describing algorithms, whether it be an English-language description or pseudo-code. By embracing the Java `class` mechanism in support of data abstraction, we have little to lose and much to gain: working code that we can test and use to compare performance for diverse clients.

application

```
% java Whitelist largeW.txt < largeT.txt
499569
984875
295754
207807
140925
161828
...
```

API `public class StaticSETofInts`
 `StaticSETofInts(int[] a)` *create a set from the values in a[]*
 `boolean contains(int key)` *is key in the set?*

typical client

```
public class Whitelist
{
    public static void main(String[] args)
    {
        int[] w = In.readInts(args[0]);
        StaticSETofInts set = new StaticSETofInts(w);
        while (!StdIn.isEmpty())
        { // Read key, print if not in whitelist.
            int key = StdIn.readInt();
            if (set.rank(key) == -1)
                StdOut.println(key);
        }
    }
}
```

implementation

```
import java.util.Arrays;

public class StaticSETofInts
{
    private int[] a;

    public StaticSETofInts(int[] keys)
    {
        a = new int[keys.length];
        for (int i = 0; i < keys.length; i++)
            a[i] = keys[i]; // defensive copy
        Arrays.sort(a);
    }

    public boolean contains(int key)
    { return rank(key) != -1; }

    private int rank(int key)
    { // Binary search.
        int lo = 0;
        int hi = a.length - 1;
        while (lo <= hi)
        { // Key is in a[lo..hi] or not present.
            int mid = lo + (hi - lo) / 2;
            if (key < a[mid]) hi = mid - 1;
            else if (key > a[mid]) lo = mid + 1;
            else return mid;
        }
        return -1;
    }
}
```

Binary search recast as an object-oriented program (an ADT for search in a set of integers)

Interface inheritance. Java provides language support for defining relationships among objects, known as *inheritance*. These mechanisms are widely used by software developers, so you will study them in detail if you take a course in software engineering. The first inheritance mechanism that we consider is known as *subtyping*, which allows us to specify a relationship between otherwise unrelated classes by specifying in an *interface* a set of common methods that each implementing class must contain. An interface is nothing more than a list of instance methods. For example, instead of using our informal API, we might have articulated an interface for `Date`:

```
public interface Datable
{
    int month();
    int day();
    int year();
}
```

and then referred to the interface in our implementation code

```
public class Date implements Datable
{
    // implementation code (same as before)
}
```

so that the Java compiler will check that it matches the interface. Adding the code `implements Datable` to any class that implements `month()`, `day()`, and `year()` provides a guarantee to any client that an object of that class can invoke those methods. This arrangement is known as *interface inheritance*—an implementing class *inherits* the interface. Interface inheritance allows us to write client programs that can manipulate

objects of *any* type that implements the interface (even a type to be created in the future), by invoking methods in the interface. We might have used interface inheritance in place of our more informal APIs, but chose not to do so to avoid dependence on specific high-level language mechanisms that are not critical to the understanding of algorithms and to avoid the extra baggage of interface files. But there are a few situations where Java conventions make

	interface	methods	section
<i>comparison</i>	<code>java.lang.Comparable</code>	<code>compareTo()</code>	2.1
	<code>java.util.Comparator</code>	<code>compare()</code>	2.5
<i>iteration</i>	<code>java.lang.Iterable</code>	<code>iterator()</code>	1.3
	<code>java.util.Iterator</code>	<code>hasNext()</code>	1.3
		<code>next()</code> <code>remove()</code>	

Java interfaces used in this book

it worthwhile for us to take advantage of interfaces: we use them for *comparison* and for *iteration*, as detailed in the table at the bottom of the previous page, and will consider them in more detail when we cover those concepts.

Implementation inheritance. Java also supports another inheritance mechanism known as *subclassing*, which is a powerful technique that enables a programmer to change behavior and add functionality without rewriting an entire class from scratch. The idea is to define a new class (*subclass*, or *derived class*) that inherits instance methods *and* instance variables from another class (*superclass*, or *base class*). The subclass contains more methods than the superclass. Moreover, the subclass can redefine or *override* methods in the superclass. Subclassing is widely used by systems programmers to build so-called *extensible* libraries—one programmer (even you) can add methods to a library built by another programmer (or, perhaps, a team of systems programmers), effectively reusing the code in a potentially huge library. For example, this approach is widely used in the development of graphical user interfaces, so that the large amount of code required to provide all the facilities that users expect (drop-down menus, cut-and-paste, access to files, and so forth) can be reused. The use of subclassing is controversial among systems and applications programmers (its advantages over interface inheritance are debatable), and we avoid it in this book because it generally works against encapsulation. Certain vestiges of the approach are built in to Java and therefore unavoidable: specifically, every class is a subtype of Java’s `Object` class. This structure enables the “convention” that every class includes an implementation of `getClass()`, `toString()`, `equals()`, `hashCode()`, and several other methods that we do not use in this book. Actually, every class *inherits* these methods from `Object` through subclassing, so any client can use them for any object. We usually override `toString()`, `equals()`, `hashCode()` in new classes because the default `Object` implementation generally does not lead to the desired behavior. We now will consider `toString()` and `equals()`; we discuss `hashCode()` in SECTION 3.4.

	method	purpose	section
Class	<code>getClass()</code>	<i>what class is this object?</i>	1.2
String	<code>toString()</code>	<i>string representation of this object</i>	1.1
boolean	<code>equals(Object that)</code>	<i>is this object equal to that?</i>	1.2
int	<code>hashCode()</code>	<i>hash code for this object</i>	3.4

Inherited methods from `Object` used in this book

String conversion. By convention, every Java type inherits `toString()` from `Object`, so any client can invoke `toString()` for any object. This convention is the basis for Java's automatic conversion of one operand of the concatenation operator `+` to a `String` whenever the other operand is a `String`. If an object's data type does not include an implementation of `toString()`, then the default implementation in `Object` is invoked, which is normally not helpful, since it typically returns a string representation of the memory address of the object. Accordingly, we generally include implementations of `toString()` that override the default in every class that we develop, as highlighted for `Date` on the facing page. As illustrated in this code, `toString()` implementations are often quite simple, implicitly (through `+`) using `toString()` for each instance variable.

Wrapper types. Java supplies built-in reference types known as *wrapper types*, one for each of the primitive types: `Boolean`, `Byte`, `Character`, `Double`, `Float`, `Integer`, `Long`, and `Short` correspond to `boolean`, `byte`, `char`, `double`, `float`, `int`, `long`, and `short`, respectively. These classes consist primarily of static methods such as `parseInt()` but they also include the inherited instance methods `toString()`, `compareTo()`, `equals()`, and `hashCode()`. Java automatically converts from primitive types to wrapper types when warranted, as described on page 122. For example, when an `int` value is concatenated with a `String`, it is converted to an `Integer` that can invoke `toString()`.

Equality. What does it mean for two objects to be equal? If we test equality with `(a == b)` where `a` and `b` are reference variables of the same type, we are testing whether they have the same identity: whether the *references* are equal. Typical clients would rather be able to test whether the *data-type values* (object state) are the same, or to implement some type-specific rule. Java gives us a head start by providing implementations both for standard types such as `Integer`, `Double`, and `String` and for more complicated types such as `File` and `URL`. When using these types of data, you can just use the built-in implementation. For example, if `x` and `y` are `String` values, then `x.equals(y)` is `true` if and only if `x` and `y` have the same length and are identical in each character position. When we define our own data types, such as `Date` or `Transaction`, we need to override `equals()`. Java's convention is that `equals()` must be an *equivalence relation*. It must be

- *Reflexive*: `x.equals(x)` is `true`.
- *Symmetric*: `x.equals(y)` is `true` if and only if `y.equals(x)`.
- *Transitive*: if `x.equals(y)` and `y.equals(z)` are `true`, then so is `x.equals(z)`.

In addition, it must take an `Object` as argument and satisfy the following properties.

- *Consistent*: multiple invocations of `x.equals(y)` consistently return the same value, provided neither object is modified.
- *Not null*: `x.equals(null)` returns `false`.

These are natural definitions, but ensuring that these properties hold, adhering to Java conventions, and avoiding unnecessary work in an implementation can be tricky, as illustrated for `Date` below. It takes the following step-by-step approach:

- If the reference to this object is the same as the reference to the argument object, return `true`. This test saves the work of doing all the other checks in this case.
- If the argument is `null`, return `false`, to adhere to the convention (and to avoid following a `null` reference in code to follow).
- If the objects are not from the same class, return `false`. To determine an object's class, we use `getClass()`. Note that we can use `==` to tell us whether two objects of type `Class` are equal because `getClass()` is guaranteed to return the same reference for all objects in any given class.
- Cast the argument from `Object` to `Date` (this cast must succeed because of the previous test).
- Return `false` if any instance variables do not match. For other classes, some other definition of equality might be appropriate. For example, we might regard two `Counter` objects as equal if their count instance variables are equal.

This implementation is a model that you can use to implement `equals()` for any type that you implement. Once you have implemented one `equals()`, you will not find it difficult to implement another.

```
public class Date
{
    private final int month;
    private final int day;
    private final int year;

    public Date(int m, int d, int y)
    { month = m; day = d; year = y; }

    public int month()
    { return month; }

    public int day()
    { return day; }

    public int year()
    { return year; }

    public String toString()
    { return month() + "/" + day() + "/" + year(); }

    public boolean equals(Object x)
    {
        if (this == x) return true;
        if (x == null) return false;
        if (this.getClass() != x.getClass()) return false;
        Date that = (Date) x;
        if (this.day != that.day) return false;
        if (this.month != that.month) return false;
        if (this.year != that.year) return false;
        return true;
    }
}
```

Overriding `toString()` and `equals()` in a data-type definition

Memory management. The ability to assign a new value to a reference variable creates the possibility that a program may have created an object that can no longer be referenced. For example, consider the three assignment statements in the figure at left. After the third assignment statement, not only do *a* and *b* refer to the same Date object (1/1/2011), but also there is no longer a reference to the Date object that was created

and used to initialize *b*. The only reference to that object was in the variable *b*, and this reference was overwritten by the assignment, so there is no way to refer to the object again. Such an object is said to be *orphaned*. Objects are also orphaned when they go out of scope. Java programs tend to create huge numbers of objects (and variables that hold primitive data-type values), but only have a need for a small number of them at any given point in time. Accordingly, programming languages and systems need mechanisms to *allocate* memory for data-type values during the time they are needed and to *free* the memory when they are no longer needed (for an object, sometime after it is orphaned). Memory management turns out to be easier for primitive types because all of the information needed for memory allocation is known at compile time. Java (and most other systems) takes care of reserving space for variables when they are declared and freeing that space when they go out of scope. Memory management for objects is more complicated: the system can allocate memory for an object when it is created, but cannot know precisely when to free the memory associated with each object because the dynamics of a program in execution determines when objects are orphaned. In many languages (such as C and C++) the programmer is responsible for both allocating and freeing memory. Doing so is tedious and notoriously

```
Date a = new Date(12, 31, 1999);
Date b = new Date(1, 1, 2011);
b = a;
```

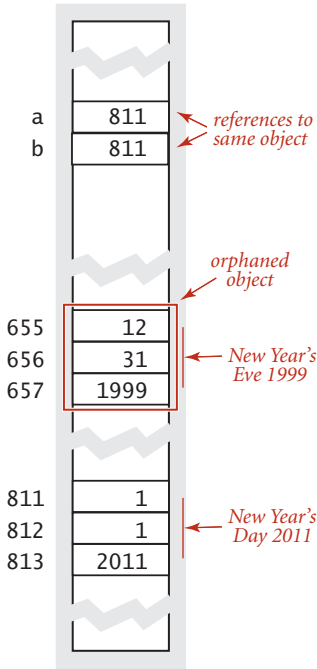

An orphaned object

error-prone. One of Java's most significant features is its ability to *automatically* manage memory. The idea is to free the programmers from the responsibility of managing memory by keeping track of orphaned objects and returning the memory they use to a pool of free memory. Reclaiming memory in this way is known as *garbage collection*. One of Java's characteristic features is its policy that references cannot be modified. This policy enables Java to do efficient automatic garbage collection. Programmers still debate whether the overhead of automatic garbage collection justifies the convenience of not having to worry about memory management.

Immutability. An *immutable* data type, such as `Date`, has the property that the value of an object never changes once constructed. By contrast, a *mutable* data type, such as `Counter` or `Accumulator`, manipulates object values that are intended to change. Java's language support for helping to enforce immutability is the `final` modifier. When you declare a variable to be `final`, you are promising to assign it a value only once, either in an initializer or in the constructor. Code that could modify the value of a `final` variable leads to a compile-time error. In our code, we use the modifier `final` with instance variables whose values never change. This policy serves as documentation that the value does not change, prevents accidental changes, and makes programs easier to debug. For example, you do not have to include a `final` value in a trace, since you know that its value never changes. A data type such as `Date` whose instance variables are all primitive and `final` is immutable (in code that does not use implementation inheritance, our convention). Whether to make a data type immutable is an important design decision and depends on the application at hand. For data types such as `Date`, the purpose of the abstraction is to encapsulate values that do not change so that we can use them in assignment statements and as arguments and return values from functions in the same way as we use primitive types (without having to worry about their values changing). A programmer implementing a `Date` client might reasonably expect to write the code `d = d0` for two `Date` variables, in the same way as for `double` or `int` values. But if `Date` were mutable and the value of `d` were to change *after* the assignment `d = d0`, then the value of `d0` would *also* change (they are both references to the same object)! On the other hand, for data types such as `Counter` and `Accumulator`, the very purpose of the abstraction is to encapsulate values as they change. You have already encountered this distinction as a client programmer, when using Java arrays (mutable) and Java's `String` data type (immutable). When you pass a `String` to a method, you do not worry about that method changing the sequence of characters in the `String`, but when you pass an array to a method, the method is free to change the contents of the array. `String` objects are immutable because we generally do *not* want `String` values to change, and Java arrays are mutable because we generally *do* want array values to change. There are also situations where we want to have mutable strings (that is the purpose of Java's `StringBuilder` class) and where we want to have immutable arrays (that is the purpose of the `Vector` class that we consider later in this section). Generally, immutable types are easier to use and harder to misuse than mutable types because the scope of code that can change their values is far smaller. It is easier to debug code that uses immutable types because it is easier to guarantee that variables in client code that uses them remain in a consistent state. When using mutable types,

mutable	immutable
<code>Counter</code>	<code>Date</code>
Java arrays	<code>String</code>

Mutable/immutable examples

you must always be concerned about where and when their values change. The downside of immutability is that *a new object must be created for every value*. This expense is normally manageable because Java garbage collectors are typically optimized for such situations. Another downside of immutability stems from the fact that, unfortunately, `final` guarantees immutability only when instance variables are primitive types, not reference types. If an instance variable of a reference type has the `final` modifier, the value of that instance variable (the reference to an object) will never change—it will always refer to the same object—but the value of the object itself *can* change. For example, this code does *not* implement an immutable type:

```
public class Vector
{
    private final double[] coords;

    public Vector(double[] a)
    { coords = a; }
    ...
}
```

A client program could create a `Vector` by specifying the entries in an array, and then (bypassing the API) change the elements of the `Vector` after construction:

```
double[] a = { 3.0, 4.0 };
Vector vector = new Vector(a);
a[0] = 0.0; // Bypasses the public API.
```

The instance variable `coords[]` is `private` and `final`, but `Vector` is mutable because the client holds a reference to the data. Immutability needs to be taken into account in any data-type design, and whether a data type is immutable should be specified in the API, so that clients know that object values will not change. In this book, our primary interest in immutability is for use in certifying the correctness of our algorithms. For example, if the type of data used for a binary search algorithm were mutable, then clients could invalidate our assumption that the array is sorted for binary search.

Design by contract. To conclude, we briefly discuss Java language mechanisms that enables you to verify assumptions about your program *as it is running*. We use two Java language mechanisms for this purpose:

- Exceptions, which generally handle unforeseen errors *outside* our control
- Assertions, which verify assumptions that we make *within* code we develop

Liberal use of both exceptions and assertions is good programming practice. We use them sparingly in the book for economy, but you will find them throughout the code on the booksite. This code aligns with a substantial amount of the surrounding commentary about each algorithm in the text that has to do with exceptional conditions and with asserted invariants.

Exceptions and errors. *Exceptions* and *errors* are disruptive events that occur while a program is running, often to signal an error. The action taken is known as *throwing an exception* or *throwing an error*. We have already encountered exceptions thrown by Java system methods in the course of learning basic features of Java: `StackOverflowError`, `ArithmeticException`, `ArrayIndexOutOfBoundsException`, `OutOfMemoryError`, and `NullPointerException` are typical examples. You can also create your own exceptions. The simplest kind is a `RuntimeException` that terminates execution of the program and prints an error message

```
throw new RuntimeException("Error message here.");
```

A general practice known as *fail fast* programming suggests that an error is more easily pinpointed if an exception is thrown as soon as an error is discovered (as opposed to ignoring the error and deferring the exception to sometime in the future).

Assertions. An *assertion* is a boolean expression that you are affirming is true at that point in the program. If the expression is `false`, the program will terminate and report an error message. We use assertions both to gain confidence in the correctness of programs and to document intent. For example, suppose that you have a computed value that you might use to index into an array. If this value were negative, it would cause an `ArrayIndexOutOfBoundsException` sometime later. But if you write the code `assert index >= 0;` you can pinpoint the place where the error occurred. You can also add an optional detail message such as

```
assert index >= 0 : "Negative index in method X";
```

to help you locate the bug. By default, assertions are disabled. You can enable them from the command line by using the `-enableassertions` flag (`-ea` for short). Assertions are for debugging: your program should not rely on assertions for normal operation since they may be disabled. When you take a course in systems programming, you will learn to use assertions to ensure that your code *never* terminates in a system error or goes into

an infinite loop. One model, known as the *design-by-contract* model of programming expresses the idea. The designer of a data type expresses a *precondition* (the condition that the client promises to satisfy when calling a method), a *postcondition* (the condition that the implementation promises to achieve when returning from a method), and *side effects* (any other change in state that the method could cause). During development, these conditions can be tested with assertions.

Summary. The language mechanisms discussed throughout this section illustrate that effective data-type design leads to nontrivial issues that are not easy to resolve. Experts are still debating the best ways to support some of the design ideas that we are discussing. Why does Java not allow functions as arguments? Why does Matlab copy arrays passed as arguments to functions? As mentioned early in CHAPTER 1, it is a slippery slope from complaining about features in a programming language to becoming a programming-language designer. If you do not plan to do so, your best strategy is to use widely available languages. Most systems have extensive libraries that you certainly should use when appropriate, but you often can simplify your client code and protect yourself by building abstractions that can easily transport to other languages. Your main goal is to develop data types so that most of your work is done at a level of abstraction that is appropriate to the problem at hand.

The table on the facing page summarizes the various kinds of Java classes that we have considered.

kind of class	examples	characteristics
<i>static methods</i>	Math StdIn StdOut	no instance variables
<i>immutable abstract data type</i>	Date Transaction String Integer	instance variables all private instance variables all final defensive copy for reference types <i>Note: these are necessary but not sufficient.</i>
<i>mutable abstract data type</i>	Counter Accumulator	instance variables all private not all instance variables final
<i>abstract data type with I/O side effects</i>	VisualAccumulator In Out Draw	instance variables all private instance methods do I/O
Java classes (data-type implementations)		

Q & A

Q. Why bother with data abstraction?

A. It helps us produce reliable and correct code. For example, in the 2000 presidential election, Al Gore received –16,022 votes on an electronic voting machine in Volusia County, Florida—the tally was clearly not properly encapsulated in the voting machine software!

Q. Why the distinction between primitive and reference types? Why not just have reference types?

A. Performance. Java provides the reference types `Integer`, `Double`, and so forth that correspond to primitive types that can be used by programmers who prefer to ignore the distinction. Primitive types are closer to the types of data that are supported by computer hardware, so programs that use them usually run faster than programs that use corresponding reference types.

Q. Do data types *have* to be abstract?

A. No. Java also allows `public` and `protected` to allow some clients to refer directly to instance variables. As described in the text, the advantages of allowing client code to directly refer to data are greatly outweighed by the disadvantages of dependence on a particular representation, so all instance variables are `private` in our code. We also occasionally use `private` instance methods to share code among public methods.

Q. What happens if I forget to use `new` when creating an object?

A. To Java, it looks as though you want to call a static method with a return value of the object type. Since you have not defined such a method, the error message is the same as anytime you refer to an undefined symbol. If you compile the code

```
Counter c = Counter("test");
```

you get this error message:

```
cannot find symbol
symbol   : method Counter(String)
```

You get the same kind of error message if you provide the wrong number of arguments to a constructor.

Q. What happens if I forget to use `new` when creating an array of objects?

A. You need to use `new` for each object that you create, so when you create an array of N objects, you need to use `new` $N+1$ times: once for the array and once for each of the objects. If you forget to create the array:

```
Counter[] a;
a[0] = new Counter("test");
```

you get the same error message that you would get when trying to assign a value to any uninitialized variable:

```
variable a might not have been initialized
  a[0] = new Counter("test");
    ^
```

but if you forget to use `new` when creating an object within the array and then try to use it to invoke a method:

```
Counter[] a = new Counter[2];
a[0].increment();
```

you get a `NullPointerException`.

Q. Why not write `StdOut.println(x.toString())` to print objects?

A. That code works fine, but Java saves us the trouble of writing it by automatically invoking the `toString()` method for any object, since `println()` has a method that takes an `Object` as argument.

Q. What is a *pointer*?

A. Good question. Perhaps that should be `NullReferenceException`. Like a Java reference, you can think of a *pointer* as a machine address. In many programming languages, the pointer is a primitive data type that programmers can manipulate in many ways. But programming with pointers is notoriously error-prone, so operations provided for pointers need to be carefully designed to help programmers avoid errors. Java takes this point of view to an extreme (that is favored by many modern programming-language designers). In Java, there is only *one* way to create a reference (`new`) and only *one* way to change a reference (with an assignment statement). That is, the only things that a programmer can do with references are to create them and copy them. In

Q & A (continued)

programming-language jargon, Java references are known as *safe pointers*, because Java can guarantee that each reference points to an object of the specified type (and it can determine which objects are not in use, for garbage collection). Programmers used to writing code that directly manipulates pointers think of Java as having no pointers at all, but people still debate whether it is really desirable to have unsafe pointers.

Q. Where can I find more details on how Java implements references and does garbage collection?

A. One Java system might differ completely from another. For example, one natural scheme is to use a pointer (machine address); another is to use a *handle* (a pointer to a pointer). The former gives faster access to data; the latter provides for better garbage collection.

Q. What exactly does it mean to `import` a name?

A. Not much: it just saves some typing. You could type `java.util.Arrays` instead of `Arrays` everywhere in your code instead of using the `import` statement.

Q. What is the problem with implementation inheritance?

A. Subtyping makes modular programming more difficult for two reasons. First, any change in the superclass affects all subclasses. The subclass cannot be developed *independently* of the superclass; indeed, it is *completely dependent* on the superclass. This problem is known as the *fragile base class* problem. Second, the subclass code, having access to instance variables, can subvert the intention of the superclass code. For example, the designer of a class like `Counter` for a voting system may take great care to make it so that `Counter` can only increment the tally by one (remember Al Gore's problem). But a subclass, with full access to the instance variable, can change it to any value whatever.

Q. How do I make a class immutable?

A. To ensure immutability of a data type that includes an instance variable of a mutable type, we need to make a local copy, known as a *defensive copy*. And that may not be enough. Making the copy is one challenge; ensuring that none of the instance methods change values is another.

Q. What is `null`?

A. It is a literal value that refers to no object. Invoking a method using the `null` reference is meaningless and results in a `NullPointerException`. If you get this error message, check to make sure that your constructor properly initializes all of its instance variables.

Q. Can I have a static method in a class that implements a data type?

A. Of course. For example, all of our classes have `main()`. Also, it is natural to consider adding static methods for operations that involve multiple objects where none of them naturally suggests itself as the one that should invoke the method. For example, we might define a static method like the following within `Point`:

```
public static double distance(Point a, Point b)
{
    return a.distTo(b);
}
```

Often, including such methods can serve to clarify client code.

Q. Are there other kinds of variables besides parameter, local, and instance variables?

A. If you include the keyword `static` in a class declaration (outside of any type) it creates a completely different type of variable, known as a *static variable*. Like instance variables, static variables are accessible to every method in the class; however, they are not associated with any object. In older programming languages, such variables are known as *global variables*, because of their global scope. In modern programming, we focus on limiting scope and therefore rarely use such variables. When we do, we will call attention to them.

Q. What is a *deprecated* method?

A. A method that is no longer fully supported, but kept in an API to maintain compatibility. For example, Java once included a method `Character.isSpace()`, and programmers wrote programs that relied on using that method's behavior. When the designers of Java later wanted to support additional Unicode whitespace characters, they could not change the behavior of `isSpace()` without breaking client programs, so, instead, they added a new method, `Character.isWhitespace()`, and deprecated the old method. As time wears on, this practice certainly complicates APIs. Sometimes, entire classes are deprecated. For example, Java deprecated its `java.util.Date` in order to better support internationalization.

EXERCISES

1.2.1 Write a `Point2D` client that takes an integer value N from the command line, generates N random points in the unit square, and computes the distance separating the *closest pair* of points.

1.2.2 Write an `Interval1D` client that takes an `int` value N as command-line argument, reads N intervals (each defined by a pair of `double` values) from standard input, and prints all pairs that intersect.

1.2.3 Write an `Interval2D` client that takes command-line arguments N , min , and max and generates N random 2D intervals whose width and height are uniformly distributed between min and max in the unit square. Draw them on `StdDraw` and print the number of pairs of intervals that intersect and the number of intervals that are contained in one another.

1.2.4 What does the following code fragment print?

```
String string1 = "hello";
String string2 = string1;
string1 = "world";
StdOut.println(string1);
StdOut.println(string2);
```

1.2.5 What does the following code fragment print?

```
String s = "Hello World";
s.toUpperCase();
s.substring(6, 11);
StdOut.println(s);
```

Answer: "Hello World". `String` objects are immutable—string methods return a new `String` object with the appropriate value (but they do not change the value of the object that was used to invoke them). This code ignores the objects returned and just prints the original string. To print "WORLD", use `s = s.toUpperCase()` and `s = s.substring(6, 11)`.

1.2.6 A string s is a *circular rotation* of a string t if it matches when the characters are circularly shifted by any number of positions; e.g., ACTGACG is a circular shift of TGACGAC, and vice versa. Detecting this condition is important in the study of genomic sequences. Write a program that checks whether two given strings s and t are circular

shifts of one another. *Hint*: The solution is a one-liner with `indexOf()`, `length()`, and string concatenation.

1.2.7 What does the following recursive function return?

```
public static String mystery(String s)
{
    int N = s.length();
    if (N <= 1) return s;
    String a = s.substring(0, N/2);
    String b = s.substring(N/2, N);
    return mystery(b) + mystery(a);
}
```

1.2.8 Suppose that `a[]` and `b[]` are each integer arrays consisting of millions of integers. What does the follow code do? Is it reasonably efficient?

```
int[] t = a; a = b; b = t;
```

Answer. It swaps them. It could hardly be more efficient because it does so by copying references, so that it is not necessary to copy millions of elements.

1.2.9 Instrument `BinarySearch` (page 47) to use a `Counter` to count the total number of keys examined during all searches and then print the total after all searches are complete. *Hint*: Create a `Counter` in `main()` and pass it as an argument to `rank()`.

1.2.10 Develop a class `VisualCounter` that allows both increment and decrement operations. Take two arguments `N` and `max` in the constructor, where `N` specifies the maximum number of operations and `max` specifies the maximum absolute value for the counter. As a side effect, create a plot showing the value of the counter each time its tally changes.

1.2.11 Develop an implementation `SmartDate` of our `Date` API that raises an exception if the date is not legal.

1.2.12 Add a method `dayOfTheWeek()` to `SmartDate` that returns a `String` value `Monday`, `Tuesday`, `Wednesday`, `Thursday`, `Friday`, `Saturday`, or `Sunday`, giving the appropriate day of the week for the date. You may assume that the date is in the 21st century.

EXERCISES *(continued)*

1.2.13 Using our implementation of `Date` as a model (page 91), develop an implementation of `Transaction`.

1.2.14 Using our implementation of `equals()` in `Date` as a model (page 103), develop implementations of `equals()` for `Transaction`.

CREATIVE PROBLEMS

1.2.15 *File input.* Develop a possible implementation of the static `readInts()` method from `In` (which we use for various test clients, such as binary search on page 47) that is based on the `split()` method in `String`.

Solution:

```
public static int[] readInts(String name)
{
    In in = new In(name);
    String input = StdIn.readAll();
    String[] words = input.split("\\s+");
    int[] ints = new int[words.length];
    for (int i = 0; i < words.length; i++)
        ints[i] = Integer.parseInt(words[i]);
    return ints;
}
```

We will consider a different implementation in SECTION 1.3 (see page 126).

1.2.16 *Rational numbers.* Implement an immutable data type `Rational` for rational numbers that supports addition, subtraction, multiplication, and division.

```
public class Rational
{
    Rational(int numerator, int denominator)
    Rational plus(Rational b)           sum of this number and b
    Rational minus(Rational b)         difference of this number and b
    Rational times(Rational b)         product of this number and b
    Rational divides(Rational b)       quotient of this number and b
    boolean equals(Rational that)      is this number equal to that?
    String toString()                  string representation
}
```

You do not have to worry about testing for overflow (see EXERCISE 1.2.17), but use as instance variables two `long` values that represent the numerator and denominator to limit the possibility of overflow. Use Euclid's algorithm (see page 4) to ensure that the numerator and denominator never have any common factors. Include a test client that exercises all of your methods.

CREATIVE PROBLEMS *(continued)*

1.2.17 *Robust implementation of rational numbers.* Use assertions to develop an implementation of `Rational` (see EXERCISE 1.2.16) that is immune to overflow.

1.2.18 *Variance for accumulator.* Validate that the following code, which adds the methods `var()` and `stddev()` to `Accumulator`, computes both the mean and variance of the numbers presented as arguments to `addDataValue()`:

```
public class Accumulator
{
    private double m;
    private double s;
    private int N;

    public void addDataValue(double x)
    {
        N++;
        s = s + 1.0 * (N-1) / N * (x - m) * (x - m);
        m = m + (x - m) / N;
    }

    public double mean()
    { return m; }

    public double var()
    { return s/(N - 1); }

    public double stddev()
    { return Math.sqrt(this.var()); }
}
```

This implementation is less susceptible to roundoff error than the straightforward implementation based on saving the sum of the squares of the numbers.

1.2.19 Parsing. Develop the parse constructors for your `Date` and `Transaction` implementations of EXERCISE 1.2.13 that take a single `String` argument to specify the initialization values, using the formats given in the table below.

Partial solution:

```
public Date(String date)
{
    String[] fields = date.split("/");
    month = Integer.parseInt(fields[0]);
    day   = Integer.parseInt(fields[1]);
    year  = Integer.parseInt(fields[2]);
}
```

type	format	example
Date	integers separated by slashes	5/22/1939
Transaction	customer, date, and amount, separated by whitespace	Turing 5/22/1939 11.99

Formats for parsing



1.3 BAGS, QUEUES, AND STACKS

SEVERAL FUNDAMENTAL DATA TYPES involve *collections* of objects. Specifically, the set of values is a collection of objects, and the operations revolve around adding, removing, or examining objects in the collection. In this section, we consider three such data types, known as the *bag*, the *queue*, and the *stack*. They differ in the specification of which object is to be removed or examined next.

Bags, queues, and stacks are fundamental and broadly useful. We use them in implementations throughout the book. Beyond this direct applicability, the client and implementation code in this section serves as an introduction to our general approach to the development of data structures and algorithms.

One goal of this section is to emphasize the idea that the way in which we represent the objects in the collection directly impacts the efficiency of the various operations. For collections, we design data structures for representing the collection of objects that can support efficient implementation of the requisite operations.

A second goal of this section is to introduce *generics* and *iteration*, basic Java constructs that substantially simplify client code. These are advanced programming-language mechanisms that are not necessarily essential to the understanding of algorithms, but their use allows us to develop client code (and implementations of algorithms) that is more clear, compact, and elegant than would otherwise be possible.

A third goal of this section is to introduce and show the importance of *linked* data structures. In particular, a classic data structure known as the *linked list* enables implementation of bags, queues, and stacks that achieve efficiencies not otherwise possible. Understanding linked lists is a key first step to the study of algorithms and data structures.

For each of the three types, we consider APIs and sample client programs, then look at possible representations of the data type values and implementations of the data-type operations. This scenario repeats (with more complicated data structures) throughout this book. The implementations here are models of implementations later in the book and worthy of careful study.

APIs As usual, we begin our discussion of abstract data types for collections by defining their APIs, shown below. Each contains a no-argument constructor, a method to add an item to the collection, a method to test whether the collection is empty, and a method that returns the size of the collection. `Stack` and `Queue` each have a method to remove a particular item from the collection. Beyond these basics, these APIs reflect two Java features that we will describe on the next few pages: *generics* and *iterable collections*.

Bag

```
public class Bag<Item> implements Iterable<Item>
```

Bag()	<i>create an empty bag</i>
void add(Item item)	<i>add an item</i>
boolean isEmpty()	<i>is the bag empty?</i>
int size()	<i>number of items in the bag</i>

FIFO queue

```
public class Queue<Item> implements Iterable<Item>
```

Queue()	<i>create an empty queue</i>
void enqueue(Item item)	<i>add an item</i>
Item dequeue()	<i>remove the least recently added item</i>
boolean isEmpty()	<i>is the queue empty?</i>
int size()	<i>number of items in the queue</i>

Pushdown (LIFO) stack

```
public class Stack<Item> implements Iterable<Item>
```

Stack()	<i>create an empty stack</i>
void push(Item item)	<i>add an item</i>
Item pop()	<i>remove the most recently added item</i>
boolean isEmpty()	<i>is the stack empty?</i>
int size()	<i>number of items in the stack</i>

APIs for fundamental generic iterable collections

Generics. An essential characteristic of collection ADTs is that we should be able to use them for any type of data. A specific Java mechanism known as *generics*, also known as *parameterized types*, enables this capability. The impact of generics on the programming language is sufficiently deep that they are not found in many languages (including early versions of Java), but our use of them in the present context involves just a small bit of extra Java syntax and is easy to understand. The notation `<Item>` after the class name in each of our APIs defines the name `Item` as a *type parameter*, a symbolic placeholder for some concrete type to be used by the client. You can read `Stack<Item>` as “stack of items.” When implementing `Stack`, we do not know the concrete type of `Item`, but a client can use our stack for any type of data, including one defined long after we develop our implementation. The client code provides a concrete type when the stack is created: we can replace `Item` with the name of *any* reference data type (consistently, everywhere it appears). This provides exactly the capability that we need. For example, you can write code such as

```
Stack<String> stack = new Stack<String>();
stack.push("Test");
...
String next = stack.pop();
```

to use a stack for `String` objects and code such as

```
Queue<Date> queue = new Queue<Date>();
queue.enqueue(new Date(12, 31, 1999));
...
Date next = queue.dequeue();
```

to use a queue for `Date` objects. If you try to add a `Date` (or data of any other type than `String`) to `stack` or a `String` (or data of any other type than `Date`) to `queue`, you will get a compile-time error. Without generics, we would have to define (and implement) different APIs for each type of data we might need to collect; with generics, we can use one API (and one implementation) for all types of data, even types that are implemented in the future. As you will soon see, generic types lead to clear client code that is easy to understand and debug, so we use them throughout this book.

Autoboxing. Type parameters have to be instantiated as *reference* types, so Java has special mechanisms to allow generic code to be used with primitive types. Recall that Java’s wrapper types are reference types that correspond to primitive types: `Boolean`, `Byte`, `Character`, `Double`, `Float`, `Integer`, `Long`, and `Short` correspond to `boolean`, `byte`, `char`, `double`, `float`, `int`, `long`, and `short`, respectively. Java automatically converts between these reference types and the corresponding primitive types—in assignments, method arguments, and arithmetic/logic expressions. In the present context,

this conversion is helpful because it enables us to use generics with primitive types, as in the following code:

```
Stack<Integer> stack = new Stack<Integer>();
stack.push(17);      // auto-boxing (int -> Integer)
int i = stack.pop(); // auto-unboxing (Integer -> int)
```

Automatically casting a primitive type to a wrapper type is known as *autoboxing*, and automatically casting a wrapper type to a primitive type is known as *auto-unboxing*. In this example, Java automatically casts (autoboxes) the primitive value 17 to be of type `Integer` when we pass it to the `push()` method. The `pop()` method returns an `Integer`, which Java casts (auto-unboxes) to an `int` before assigning it to the variable `i`.

Iterable collections. For many applications, the client's requirement is just to process each of the items in some way, or to *iterate* through the items in the collection. This paradigm is so important that it has achieved first-class status in Java and many other modern languages (the programming language itself has specific mechanisms to support it, not just the libraries). With it, we can write clear and compact code that is free from dependence on the details of a collection's implementation. For example, suppose that a client maintains a collection of transactions in a `Queue`, as follows:

```
Queue<Transaction> collection = new Queue<Transaction>();
```

If the collection is iterable, the client can print a transaction list with a single statement:

```
for (Transaction t : collection)
{   StdOut.println(t); } }
```

This construct is known as the *foreach* statement: you can read the `for` statement as *for each transaction t in the collection, execute the following block of code*. This client code does not need to know anything about the representation or the implementation of the collection; it just wants to process each of the items in the collection. The same `for` loop would work with a `Bag` of transactions or any other iterable collection. We could hardly imagine client code that is more clear and compact. As you will see, supporting this capability requires extra effort in the implementation, but this effort is well worthwhile.

IT IS INTERESTING TO NOTE that the only differences between the APIs for `Stack` and `Queue` are their names and the names of the methods. This observation highlights the idea that we cannot easily specify all of the characteristics of a data type in a list of method signatures. In this case, the true specification has to do with the English-language descriptions that specify the rules by which an item is chosen to be removed (or to be processed next in the *foreach* statement). Differences in these rules are profound, *part of the API*, and certainly of critical importance in developing client code.

Bags. A *bag* is a collection where removing items is not supported—its purpose is to provide clients with the ability to collect items and then to iterate through the collected items (the client can also test if a bag is empty and find its number of items). The order of iteration is unspecified and should be immaterial to the client. To appreciate the concept, consider the idea of an avid marble collector, who might put marbles in a bag, one at a time, and periodically process all the marbles to look for one having some particular characteristic. With our Bag API, a client can add items to a bag and process them all with a *foreach* statement whenever needed. Such a client could use a stack or a queue, but one way to emphasize that the order in which items are processed is immaterial is to use a Bag. The class `Stats` at right illustrates a typical Bag client. The task is simply to compute the average and the sample standard deviation of the `double` values on standard input. If there are N numbers on standard input, their average is computed by adding the numbers and dividing by N ; their sample standard deviation is computed by adding the squares of the difference between each number and the average, dividing by $N-1$, and taking the square root. The order in which the numbers are considered is not relevant for either of these calculations, so we save them in a Bag and use the *foreach* construct to compute each sum. *Note:* It is possible to compute the standard deviation without saving all the numbers (as we did for the average in `Accumulator`—see EXERCISE 1.2.18). Keeping the all numbers in a Bag is required for more complicated statistics.

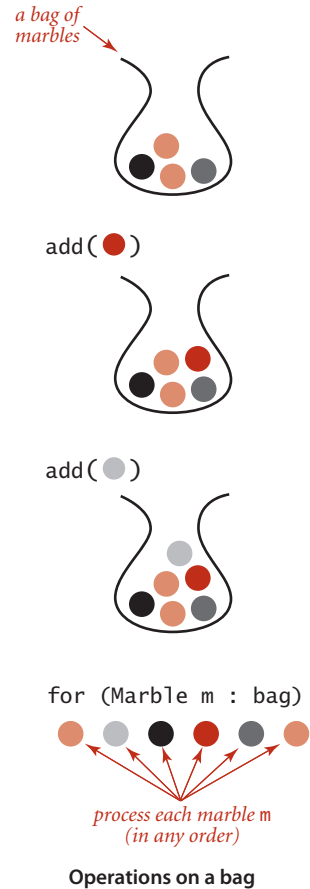

typical Bag client

```
public class Stats
{
    public static void main(String[] args)
    {
        Bag<Double> numbers = new Bag<Double>();
        while (!StdIn.isEmpty())
            numbers.add(StdIn.readDouble());
        int N = numbers.size();

        double sum = 0.0;
        for (double x : numbers)
            sum += x;
        double mean = sum/N;

        sum = 0.0;
        for (double x : numbers)
            sum += (x - mean)*(x - mean);
        double std = Math.sqrt(sum/(N-1));

        StdOut.printf("Mean: %.2f\n", mean);
        StdOut.printf("Std dev: %.2f\n", std);
    }
}
```

application

```
% java Stats
100
99
101
120
98
107
109
81
101
90

Mean: 100.60
Std dev: 10.51
```

FIFO queues. A *FIFO queue* (or just a *queue*) is a collection that is based on the *first-in-first-out* (FIFO) policy. The policy of doing tasks in the same order that they arrive

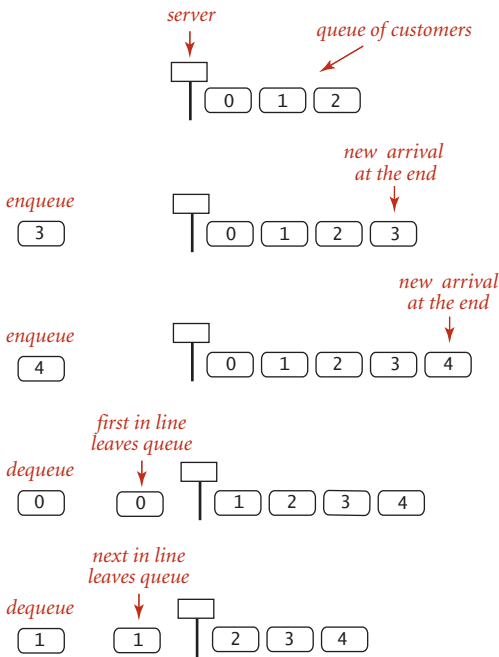

A typical FIFO queue

is one that we encounter frequently in everyday life: from people waiting in line at a theater, to cars waiting in line at a toll booth, to tasks waiting to be serviced by an application on your computer. One bed-rock principle of any service policy is the perception of fairness. The first idea that comes to mind when most people think about fairness is that whoever has been waiting the longest should be served first. That is precisely the FIFO discipline. Queues are a natural model for many everyday phenomena, and they play a central role in numerous applications. When a client iterates through the items in a queue with the *foreach* construct, the items are processed in the order they were added to the queue. A typical reason to use a queue in an application is to save items in a collection while at the same time *preserving their relative order*: they come out in the same order in which they were put in. For example, the client below is a possible implementation of the `readDoubles()` static method from our `In` class. The problem that this method solves for the client is that the client can get numbers from a file into an array *without knowing the file size ahead of time*. We *enqueue* the numbers from the file, use the `size()` method from `Queue` to find the size needed for the array, create the array, and then *dequeue* the numbers to move them to the array. A queue is appropriate because it puts the numbers into the array in the order in which they appear in the file (we might use a `Bag` if that order is immaterial). This code uses autoboxing and auto-unboxing to convert between the client's `double` primitive type and the queue's `Double` wrapper type.

is that the client can get numbers from a file into an

```
public static int[] readInts(String name)
{
    In in = new In(name);
    Queue<Integer> q = new Queue<Integer>();
    while (!in.isEmpty())
        q.enqueue(in.readInt());

    int N = q.size();
    int[] a = new int[N];
    for (int i = 0; i < N; i++)
        a[i] = q.dequeue();
    return a;
}
```

Sample Queue client

Pushdown stacks. A *pushdown stack* (or just a *stack*) is a collection that is based on the *last-in-first-out* (LIFO) policy. When you keep your mail in a pile on your desk, you are using a stack. You pile pieces of new mail on the top when they arrive and take each piece of mail from the top when you are ready to read it. People do not process as many papers as they did in the past, but the same organizing principle underlies several of the applications that you use regularly on your computer. For example, many people organize their email as a stack—they *push* messages on the top when they are received and *pop* them from the top when they read them, with most recently received first (last in, first out). The advantage of this strategy is that we see interesting email as soon as possible; the disadvantage is that some old email might never get read if we never empty the stack. You have likely encountered another common example of a stack when surfing the web. When you click a hyperlink, your browser displays the new page (and pushes onto a stack). You can keep clicking on hyperlinks to visit new pages, but you can always revisit the previous page by clicking the back button (popping it from the stack). The LIFO policy offered by a stack provides just the behavior that you expect. When a client iterates through the items in a stack with the *foreach* construct, the items are processed in the *reverse* of the order in which they were added. A typical reason to use a stack iterator in an application is to save items in a collection while at the same time *reversing* their relative order. For example, the client `Reverse` at right reverses the order of the integers on standard input, again without having to know ahead of time how many there are. The importance of stacks in computing is fundamental and profound, as indicated in the detailed example that we consider next.

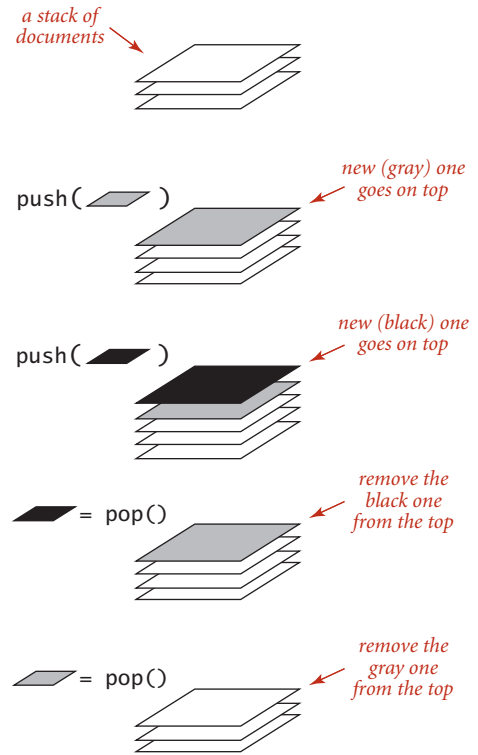

Operations on a pushdown stack

```
public class Reverse
{
    public static void main(String[] args)
    {
        Stack<Integer> stack;
        stack = new Stack<Integer>();
        while (!StdIn.isEmpty())
            stack.push(StdIn.readInt());

        for (int i : stack)
            StdOut.println(i);
    }
}
```

Sample Stack client

Arithmetic expression evaluation. As another example of a stack client, we consider a classic example that also demonstrates the utility of generics. Some of the first programs that we considered in SECTION 1.1 involved computing the value of arithmetic expressions like this one:

$$(1 + ((2 + 3) * (4 * 5)))$$

If you multiply 4 by 5, add 3 to 2, multiply the result, and then add 1, you get the value 101. But how does the Java system do this calculation? Without going into the details of how the Java system is built, we can address the essential ideas by writing a Java program that can take a string as input (the expression) and produce the number represented by the expression as output. For simplicity, we begin with the following explicit recursive definition: an *arithmetic expression* is either a number, or a left parenthesis followed by an arithmetic expression followed by an operator followed by another arithmetic expression followed by a right parenthesis. For simplicity, this definition is for *fully parenthesized* arithmetic expressions, which specify precisely which operators apply to which operands—you are a bit more familiar with expressions such as $1 + 2 * 3$, where we often rely on precedence rules instead of parentheses. The same basic mechanisms that we consider can handle precedence rules, but we avoid that complication. For specificity, we support the familiar binary operators $*$, $+$, $-$, and $/$, as well as a square-root operator `sqrt` that takes just one argument. We could easily allow more operators and more kinds of operators to embrace a large class of familiar mathematical expressions, involving trigonometric, exponential, and logarithmic functions. Our focus is on understanding how to interpret the string of parentheses, operators, and numbers to enable performing in the proper order the low-level arithmetic operations that are available on any computer. Precisely how can we convert an arithmetic expression—a string of characters—to the value that it represents? A remarkably simple algorithm that was developed by E. W. Dijkstra in the 1960s uses two stacks (one for operands and one for operators) to do this job. An expression consists of parentheses, operators, and operands (numbers). Proceeding from left to right and taking these entities one at a time, we manipulate the stacks according to four possible cases, as follows:

- Push *operands* onto the operand stack.
- Push *operators* onto the operator stack.
- Ignore *left* parentheses.
- On encountering a *right* parenthesis, pop an operator, pop the requisite number of operands, and push onto the operand stack the result of applying that operator to those operands.

After the final right parenthesis has been processed, there is one value on the stack, which is the value of the expression. This method may seem mysterious at first, but it

Dijkstra's Two-Stack Algorithm for Expression Evaluation

```

public class Evaluate
{
    public static void main(String[] args)
    {
        Stack<String> ops = new Stack<String>();
        Stack<Double> vals = new Stack<Double>();
        while (!StdIn.isEmpty())
        { // Read token, push if operator.
            String s = StdIn.readString();
            if (s.equals("(")) ;
            else if (s.equals("+")) ops.push(s);
            else if (s.equals("-")) ops.push(s);
            else if (s.equals("*")) ops.push(s);
            else if (s.equals("/")) ops.push(s);
            else if (s.equals("sqrt")) ops.push(s);
            else if (s.equals(")"))
            { // Pop, evaluate, and push result if token is ")".
                String op = ops.pop();
                double v = vals.pop();
                if (op.equals("+")) v = vals.pop() + v;
                else if (op.equals("-")) v = vals.pop() - v;
                else if (op.equals("*")) v = vals.pop() * v;
                else if (op.equals("/")) v = vals.pop() / v;
                else if (op.equals("sqrt")) v = Math.sqrt(v);
                vals.push(v);
            } // Token not operator or paren: push double value.
            else vals.push(Double.parseDouble(s));
        }
        StdOut.println(vals.pop());
    }
}

```

This Stack client uses two stacks to evaluate arithmetic expressions, illustrating an essential computational process: interpreting a string as a program and executing that program to compute the desired result. With generics, we can use the code in a single Stack implementation to implement one stack of String values and another stack of Double values. For simplicity, this code assumes that the expression is fully parenthesized, with numbers and characters separated by whitespace.

```

% java Evaluate
( 1 + ( ( 2 + 3 ) * ( 4 * 5 ) ) )
101.0

% java Evaluate
( ( 1 + sqrt ( 5.0 ) ) ) / 2.0 )
1.618033988749895

```

is easy to convince yourself that it computes the proper value: any time the algorithm encounters a subexpression consisting of two operands separated by an operator, all surrounded by parentheses, it leaves the result of performing that operation on those operands on the operand stack. The result is the same as if that value had appeared in the input instead of the subexpression, so we can think of replacing the subexpression by the value to get an expression that would yield the same result. We can apply this argument again and again until we get a single value. For example, the algorithm computes the same value for all of these expressions:

```
( 1 + ( ( 2 + 3 ) * ( 4 * 5 ) ) )  
( 1 + ( 5 * ( 4 * 5 ) ) )  
( 1 + ( 5 * 20 ) )  
( 1 + 100 )  
101
```

Evaluate on the previous page is an implementation of this algorithm. This code is a simple example of an *interpreter*: a program that interprets the computation specified by a given string and performs the computation to arrive at the result.

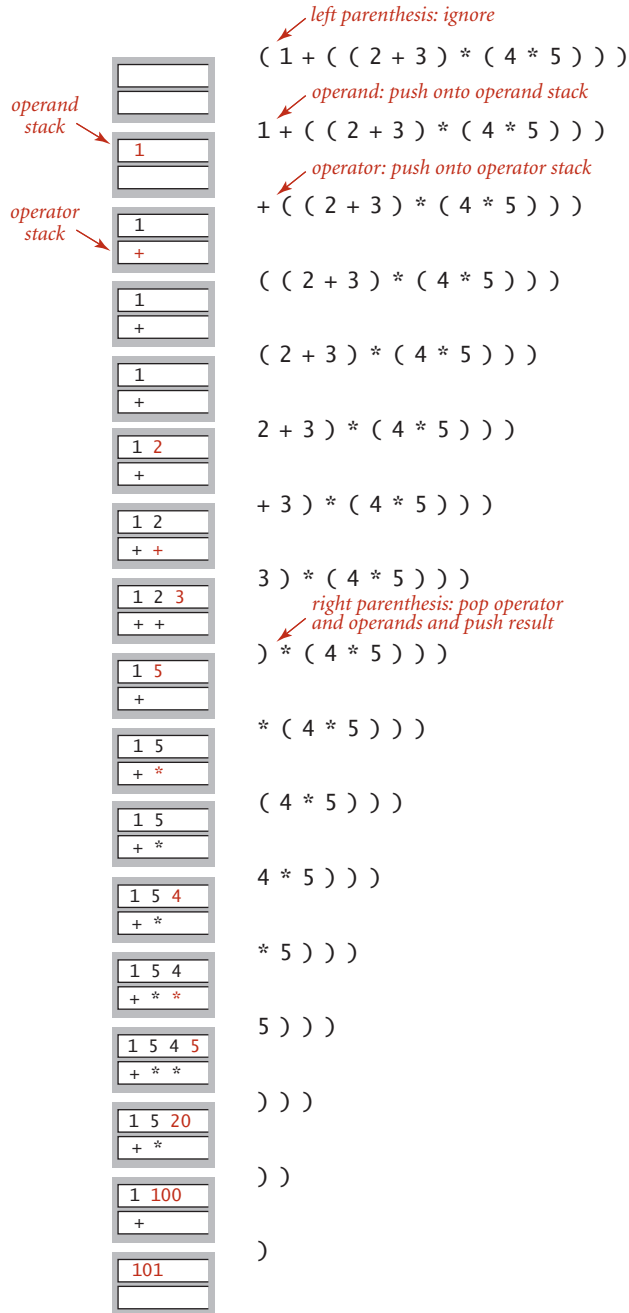

Trace of Dijkstra's two-stack arithmetic expression-evaluation algorithm

Implementing collections To address the issue of implementing Bag, Stack and Queue, we begin with a simple classic implementation, then address improvements that lead us to implementations of the APIs articulated on page 121.

Fixed-capacity stack. As a strawman, we consider an abstract data type for a fixed-capacity stack of strings, shown on the opposite page. The API differs from our Stack API: it works only for String values, it requires the client to specify a capacity, and it does not support iteration. The primary choice in developing an API implementation is to *choose a representation for the data*. For FixedCapacityStackOfStrings, an obvious choice is to use an array of String values. Pursuing this choice leads to the implementation shown at the bottom on the opposite page, which could hardly be simpler (each method is a one-liner). The instance variables are an array a[] that holds the items in the stack and an integer N that counts the number of items in the stack. To remove an item, we decrement N and then return a[N]; to insert a new item, we set a[N] equal to the new item and then increment N. These operations preserve the following properties:

- The items in the array are in their insertion order.
- The stack is empty when N is 0.
- The top of the stack (if it is nonempty) is at a[N-1].

As usual, thinking in terms of invariants of this sort is the easiest way to verify that an implementation operates as intended. *Be sure that you fully understand this implementation.* The best way to do so is to examine a trace of the stack contents for a sequence of

operations, as illustrated at left for the test client, which reads strings from standard input and pushes each string onto a stack, unless it is "-", when it pops the stack and prints the result. The primary performance characteristic of this implementation is that the *push and pop operations take time independent of the stack size*. For many applications, it is the method of choice because of its simplicity. But it has several drawbacks that limit its potential applicability as a general-purpose tool, which we now address. With a moderate amount of effort (and some help from Java language mechanisms), we can develop an implementation that is broadly useful. This effort is worthwhile because the implementations that we develop serve as a model for implementations of other, more powerful, abstract data types throughout the book.

StdIn (push)	StdOut (pop)	N	a[]					
			0	1	2	3	4	
		0						
to		1	to					
be		2	to	be				
or		3	to	be	or			
not		4	to	be	or	not		
to		5	to	be	or	not	to	
-	to	4	to	be	or	not	to	
be		5	to	be	or	not	be	
-	be	4	to	be	or	not	be	
-	not	3	to	be	or	not	be	
that		4	to	be	or	that	be	
-	that	3	to	be	or	that	be	
-	or	2	to	be	or	that	be	
-	be	1	to	be	or	that	be	
is		2	to	is	or	not	to	

Trace of FixedCapacityStackOfStrings test client

API `public class FixedCapacityStackOfStrings`

<code>FixedCapacityStackOfStrings(int cap)</code>	<i>create an empty stack of capacity cap</i>
<code>void push(String item)</code>	<i>add a string</i>
<code>String pop()</code>	<i>remove the most recently added string</i>
<code>boolean isEmpty()</code>	<i>is the stack empty?</i>
<code>int size()</code>	<i>number of strings on the stack</i>

test client

```
public static void main(String[] args)
{
    FixedCapacityStackOfStrings s;
    s = new FixedCapacityStackOfStrings(100);
    while (!StdIn.isEmpty())
    {
        String item = StdIn.readString();
        if (!item.equals("-"))
            s.push(item);
        else if (!s.isEmpty()) StdOut.print(s.pop() + " ");
    }
    StdOut.println("(" + s.size() + " left on stack");
}
```

application

```
% more tobe.txt
to be or not to - be - - that - - - is
% java FixedCapacityStackOfStrings < tobe.txt
to be not that or be (2 left on stack)
```

implementation

```
public class FixedCapacityStackOfStrings
{
    private String[] a; // stack entries
    private int N;     // size

    public FixedCapacityStackOfStrings(int cap)
    { a = new String[cap]; }

    public boolean isEmpty() { return N == 0; }
    public int size()       { return N; }

    public void push(String item)
    { a[N++] = item; }

    public String pop()
    { return a[--N]; }
}
```

An abstract data type for a fixed-capacity stack of strings

Generics. The first drawback of `FixedCapacityStackOfStrings` is that it works only for `String` objects. If we want a stack of `double` values, we would need to develop another class with similar code, essentially replacing `String` with `double` everywhere. This is easy enough but becomes burdensome when we consider building a stack of `Transaction` values or a queue of `Date` values, and so forth. As discussed on page 122, Java’s parameterized types (generics) are specifically designed to address this situation, and we saw several examples of client code (on pages 125, 126, 127, and 129). But how do we *implement* a generic stack? The code on the facing page shows the details. It implements a class `FixedCapacityStack` that differs from `FixedCapacityStackOfStrings` only in the code highlighted in red—we replace every occurrence of `String` with `Item` (with one exception, discussed below) and declare the class with the following first line of code:

```
public class FixedCapacityStack<Item>
```

The name `Item` is a *type parameter*, a symbolic placeholder for some concrete type to be used by the client. You can read `FixedCapacityStack<Item>` as *stack of items*, which is precisely what we want. When implementing `FixedCapacityStack`, we do not know the actual type of `Item`, but a client can use our stack for any type of data by providing a concrete type when the stack is created. Concrete types must be reference types, but clients can depend on autoboxing to convert primitive types to their corresponding wrapper types. Java uses the type parameter `Item` to check for type mismatch errors—even though no concrete type is yet known, variables of type `Item` must be assigned values of type `Item`, and so forth. But there is one significant hitch in this story: We would like to implement the constructor in `FixedCapacityStack` with the code

```
a = new Item[cap];
```

which calls for creation of a generic array. For historical and technical reasons beyond our scope, *generic array creation is disallowed in Java*. Instead, we need to use a cast:

```
a = (Item[]) new Object[cap];
```

This code produces the desired effect (though the Java compiler gives a warning, which we can safely ignore), and we use this idiom throughout the book (the Java system library implementations of similar abstract data types use the same idiom).

API	<pre>public class FixedCapacityStack<Item> FixedCapacityStack(int cap) void push(Item item) Item pop() boolean isEmpty() int size()</pre>	<hr/> <p><i>create an empty stack of capacity cap</i></p> <p><i>add an item</i></p> <p><i>remove the most recently added item</i></p> <p><i>is the stack empty?</i></p> <p><i>number of items on the stack</i></p>
------------	---	--

test client

```
public static void main(String[] args)
{
    FixedCapacityStack<String> s;
    s = new FixedCapacityStack<String>(100);
    while (!StdIn.isEmpty())
    {
        String item = StdIn.readString();
        if (!item.equals("-"))
            s.push(item);
        else if (!s.isEmpty()) StdOut.print(s.pop() + " ");
    }
    StdOut.println("(" + s.size() + " left on stack)");
}
```

application

```
% more tobe.txt
to be or not to - be - - that - - - is
% java FixedCapacityStack < tobe.txt
to be not that or be (2 left on stack)
```

implementation

```
public class FixedCapacityStack<Item>
{
    private Item[] a; // stack entries
    private int N; // size

    public FixedCapacityStack(int cap)
    { a = (Item[]) new Object[cap]; }

    public boolean isEmpty() { return N == 0; }
    public int size() { return N; }

    public void push(Item item)
    { a[N++] = item; }

    public Item pop()
    { return a[--N]; }
}
```

An abstract data type for a fixed-capacity generic stack

Array resizing. Choosing an array to represent the stack contents implies that clients must estimate the maximum size of the stack ahead of time. In Java, we cannot change the size of an array once created, so the stack always uses space proportional to that maximum. A client that chooses a large capacity risks wasting a large amount of memory at times when the collection is empty or nearly empty. For example, a transaction system might involve billions of items and thousands of collections of them. Such a client would have to allow for the possibility that each of those collections could hold all of those items, even though a typical constraint in such systems is that each item can appear in only one collection. Moreover, every client risks *overflow* if the collection grows larger than the array. For this reason, `push()` needs code to test for a full stack, and we should have an `isFull()` method in the API to allow clients to test for that condition. We omit that code, because our desire is to relieve the client from having to deal with the concept of a full stack, as articulated in our original `Stack` API. Instead, we modify the array implementation to dynamically adjust the size of the array `a[]` so that it is both sufficiently large to hold all of the items and not so large as to waste an excessive amount of space. Achieving these goals turns out to be remarkably easy. First, we implement a method that moves a stack into an array of a different size:

```
private void resize(int max)
{ // Move stack of size N <= max to a new array of size max.
  Item[] temp = (Item[]) new Object[max];
  for (int i = 0; i < N; i++)
    temp[i] = a[i];
  a = temp;
}
```

Now, in `push()`, we check whether the array is too small. In particular, we check whether there is room for the new item in the array by checking whether the stack size `N` is equal to the array size `a.length`. If there is no room, we *double* the size of the array. Then we simply insert the new item with the code `a[N++] = item`, as before:

```
public void push(String item)
{ // Add item to top of stack.
  if (N == a.length) resize(2*a.length);
  a[N++] = item;
}
```

Similarly, in `pop()`, we begin by deleting the item, then we *halve* the array size if it is too large. If you think a bit about the situation, you will see that the appropriate test is whether the stack size is less than *one-fourth* the array size. After the array is halved, it will be about half full and can accommodate a substantial number of `push()` and `pop()` operations before having to change the size of the array again.

```

public String pop()
{ // Remove item from top of stack.
  String item = a[--N];
  a[N] = null; // Avoid loitering (see text).
  if (N > 0 && N == a.length/4) resize(a.length/2);
  return item;
}

```

With this implementation, the stack never overflows and never becomes less than one-quarter full (unless the stack is empty, when the array size is 1). We will address the performance analysis of this approach in more detail in SECTION 1.4.

Loitering. Java’s garbage collection policy is to reclaim the memory associated with any objects that can no longer be accessed. In our `pop()` implementations, the reference to the popped item remains in the array. The item is effectively an *orphan*—it will never be accessed again—but the Java garbage collector has no way to know this until it is overwritten. Even when the client is done with the item, the reference in the array may keep it alive. This condition (holding a reference to an item that is no longer needed) is known as *loitering*. In this case, loitering is easy to avoid, by setting the array entry corresponding to the popped item to `null`, thus overwriting the unused reference and making it possible for the system to reclaim the memory associated with the popped item when the client is finished with it.

push()	pop()	N	a.length	a[]								
				0	1	2	3	4	5	6	7	
		0	1	null								
to		1	1	to								
be		2	2	to	be							
or		3	4	to	be	or	null					
not		4	4	to	be	or	not					
to		5	8	to	be	or	not	to	null	null	null	null
-	to	4	8	to	be	or	not	null	null	null	null	null
be		5	8	to	be	or	not	be	null	null	null	null
-	be	4	8	to	be	or	not	null	null	null	null	null
-	not	3	8	to	be	or	null	null	null	null	null	null
that		4	8	to	be	or	that	null	null	null	null	null
-	that	3	8	to	be	or	null	null	null	null	null	null
-	or	2	4	to	be	null	null					
-	be	1	2	to	null							
is		2	2	to	is							

Trace of array resizing during a sequence of `push()` and `pop()` operations

Iteration. As mentioned earlier in this section, one of the fundamental operations on collections is to process each item by *iterating* through the collection using Java's *foreach* statement. This paradigm leads to clear and compact code that is free from dependence on the details of a collection's implementation. To consider the task of implementing iteration, we start with a snippet of client code that prints all of the items in a collection of strings, one per line:

```
Stack<String> collection = new Stack<String>();
...
for (String s : collection)
    StdOut.println(s);
...
```

Now, this *foreach* statement is shorthand for a *while* construct (just like the *for* statement itself). It is essentially equivalent to the following *while* statement:

```
Iterator<String> i = collection.iterator();
while (i.hasNext())
{
    String s = i.next();
    StdOut.println(s);
}
```

This code exposes the ingredients that we need to implement in any iterable collection:

- The collection must implement an `iterator()` method that returns an `Iterator` object.
- The `Iterator` class must include two methods: `hasNext()` (which returns a `boolean` value) and `next()` (which returns a generic item from the collection).

In Java, we use the *interface* mechanism to express the idea that a class implements a specific method (see page 100). For iterable collections, the necessary interfaces are already defined for us in Java. To make a class iterable, the first step is to add the phrase `implements Iterable<Item>` to its declaration, matching the interface

```
public interface Iterable<Item>
{
    Iterator<Item> iterator();
}
```

(which is in `java.lang.Iterable`), and to add a method `iterator()` to the class that returns an `Iterator<Item>`. Iterators are generic, so we can use our parameterized type `Item` to allow clients to iterate through objects of whatever type is provided by our client. For the array representation that we have been using, we need to iterate through

an array in reverse order, so we name the iterator `ReverseArrayIterator` and add this method:

```
public Iterator<Item> iterator()
{ return new ReverseArrayIterator(); }
```

What is an iterator? An object from a class that implements the methods `hasNext()` and `next()`, as defined in the following interface (which is in `java.util.Iterator`):

```
public interface Iterator<Item>
{
    boolean hasNext();
    Item next();
    void remove();
}
```

Although the interface specifies a `remove()` method, we always use an empty method for `remove()` in this book, because interleaving iteration with operations that modify the data structure is best avoided. For `ReverseArrayIterator`, these methods are all one-liners, implemented in a nested class within our stack class:

```
private class ReverseArrayIterator implements Iterator<Item>
{
    private int i = N;

    public boolean hasNext() { return i > 0; }
    public Item next()      { return a[--i]; }
    public void remove()   { }
}
```

Note that this nested class can access the instance variables of the enclosing class, in this case `a[]` and `N` (this ability is the main reason we use nested classes for iterators). Technically, to conform to the `Iterator` specification, we should throw exceptions in two cases: an `UnsupportedOperationException` if a client calls `remove()` and a `NoSuchElementException` if a client calls `next()` when `i` is 0. Since we only use iterators in the *foreach* construction where these conditions do not arise, we omit this code. One crucial detail remains: we have to include

```
import java.util.Iterator;
```

at the beginning of the program because (for historical reasons) `Iterator` is not part of `java.lang` (even though `Iterable` is part of `java.lang`). Now a client using the *foreach* statement for this class will get behavior equivalent to the common `for` loop for arrays, but does not need to be aware of the array representation (an implementation

detail). This arrangement is of critical importance for implementations of fundamental data types like the collections that we consider in this book and those included in Java libraries. For example, it frees us to switch to a totally different representation *without having to change any client code*. More important, taking the client's point of view, it allows clients to use iteration *without having to know any details of the class implementation*.

ALGORITHM 1.1 is an implementation of our Stack API that resizes the array, allows clients to make stacks for any type of data, and supports client use of *foreach* to iterate through the stack items in LIFO order. This implementation is based on Java language nuances involving `Iterator` and `Iterable`, but there is no need to study those nuances in detail, as the code itself is not complicated and can be used as a template for other collection implementations.

For example, we can implement the Queue API by maintaining two indices as instance variables, a variable `head` for the beginning of the queue and a variable `tail` for the end of the queue. To remove an item, use `head` to access it and then increment `head`; to insert an item, use `tail` to store it, and then increment `tail`. If incrementing an index brings it past the end of the array, reset it to 0. Developing the details of checking when the queue is empty and when the array is full and needs resizing is an interesting and worthwhile programming exercise (see EXERCISE 1.3.14).

StdIn (<i>enqueue</i>)	StdOut (<i>dequeue</i>)	N	head	tail	a[]							
					0	1	2	3	4	5	6	7
		5	0	5	to	be	or	not	to			
-	to	4	1	5	to	be	or	not	to			
be		5	1	6	to	be	or	not	to	be		
-	be	4	2	6	to	be	or	not	to	be		
-	or	3	3	6	to	be	or	that	to	be		

Trace of ResizingArrayQueue test client

In the context of the study of algorithms, ALGORITHM 1.1 is significant because it almost (but not quite) achieves optimum performance goals for any collection implementation:

- Each operation should require time independent of the collection size.
- The space used should always be within a constant factor of the collection size.

The flaw in `ResizingArrayStack` is that some *push* and *pop* operations require resizing: this takes time proportional to the size of the stack. Next, we consider a way to correct this flaw, using a fundamentally different way to structure data.

ALGORITHM 1.1 Pushdown (LIFO) stack (resizing array implementation)

```

import java.util.Iterator;
public class ResizingArrayStack<Item> implements Iterable<Item>
{
    private Item[] a = (Item[]) new Object[1]; // stack items
    private int N = 0;                        // number of items

    public boolean isEmpty() { return N == 0; }
    public int size()        { return N;      }

    private void resize(int max)
    { // Move stack to a new array of size max.
      Item[] temp = (Item[]) new Object[max];
      for (int i = 0; i < N; i++)
          temp[i] = a[i];
      a = temp;
    }

    public void push(Item item)
    { // Add item to top of stack.
      if (N == a.length) resize(2*a.length);
      a[N++] = item;
    }

    public Item pop()
    { // Remove item from top of stack.
      Item item = a[--N];
      a[N] = null; // Avoid loitering (see text).
      if (N > 0 && N == a.length/4) resize(a.length/2);
      return item;
    }

    public Iterator<Item> iterator()
    { return new ReverseArrayIterator(); }

    private class ReverseArrayIterator implements Iterator<Item>
    { // Support LIFO iteration.
      private int i = N;
      public boolean hasNext() { return i > 0; }
      public Item next()      { return a[--i]; }
      public void remove()   { }
    }
}

```

This generic, iterable implementation of our Stack API is a model for collection ADTs that keep items in an array. It resizes the array to keep the array size within a constant factor of the stack size.

Linked lists Now we consider the use of a fundamental data structure that is an appropriate choice for representing the data in a collection ADT implementation. This is our first example of building a data structure that is not directly supported by the Java language. Our implementation serves as a model for the code that we use for building more complex data structures throughout the book, so you should read this section carefully, even if you have experience working with linked lists.

Definition. A *linked list* is a recursive data structure that is either empty (*null*) or a reference to a *node* having a generic item and a reference to a linked list.

The *node* in this definition is an abstract entity that might hold any kind of data, in addition to the node reference that characterizes its role in building linked lists. As with a recursive program, the concept of a recursive data structure can be a bit mindbending at first, but is of great value because of its simplicity.

Node record. With object-oriented programming, implementing linked lists is not difficult. We start with a *nested class* that defines the node abstraction:

```
private class Node
{
    Item item;
    Node next;
}
```

A `Node` has two instance variables: an `Item` (a parameterized type) and a `Node`. We define `Node` within the class where we want to use it, and make it `private` because it is not for use by clients. As with any data type, we create an object of type `Node` by invoking the (no-argument) constructor with `new Node()`. The result is a reference to a `Node` object whose instance variables are both initialized to the value `null`. The `Item` is a placeholder for any data that we might want to structure with a linked list (we will use Java's generic mechanism so that it can represent any reference type); the instance variable of type `Node` characterizes the linked nature of the data structure. To emphasize that we are just using the `Node` class to structure the data, we define no methods and we refer directly to the instance variables in code: if `first` is a variable associated with an object of type `Node`, we can refer to the instance variables with the code `first.item` and `first.next`. Classes of this kind are sometimes called *records*. They do not implement abstract data types because we refer directly to instance variables. However, `Node` and its client code are in the same class in all of our implementations and not accessible by clients of that class, so we still enjoy the benefits of data abstraction.

Building a linked list. Now, from the recursive definition, we can represent a linked list with a variable of type `Node` simply by ensuring that its value is either *null* or a reference to a `Node` whose `next` field is a reference to a linked list. For example, to build a linked list that contains the items `to`, `be`, and `or`, we create a `Node` for each item:

```
Node first = new Node();
Node second = new Node();
Node third = new Node();
```

and set the `item` field in each of the nodes to the desired value (for simplicity, these examples assume that `Item` is `String`):

```
first.item = "to";
second.item = "be";
third.item = "or";
```

and set the `next` fields to build the linked list:

```
first.next = second;
second.next = third;
```

(Note that `third.next` remains `null`, the value it was initialized to at the time of creation.) As a result, `third` is a linked list (it is a reference to a node that has a reference to `null`, which is the null reference to an empty linked list), and `second` is a linked list (it is a reference to a node that has a reference to `third`, which is a linked list), and `first` is a linked list (it is a reference to a node that has a reference to `second`, which is a linked list). The code that we will examine does these assignment statements in a different order, depicted in the diagram on this page.

```
Node first = new Node();
first.item = "to";
```

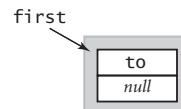

```
Node second = new Node();
second.item = "be";
first.next = second;
```

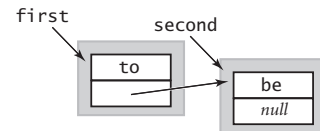

```
Node third = new Node();
third.item = "or";
second.next = third;
```

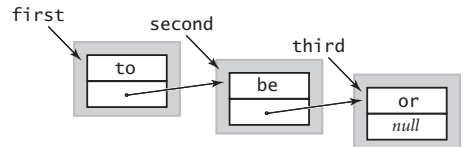

Linking together a list

A LINKED LIST REPRESENTS A SEQUENCE of items. In the example just considered, `first` represents the sequence `to be or`. We can also use an array to represent a sequence of items. For example, we could use

```
String[] s = { "to", "be", "or" };
```

to represent the same sequence of strings. The difference is that it is easier to insert items into the sequence and to remove items from the sequence with linked lists. Next, we consider code to accomplish these tasks.

When tracing code that uses linked lists and other linked structures, we use a visual representation where

- We draw a rectangle to represent each object
- We put the values of instance variables within the rectangle
- We use arrows that point to the referenced objects to depict references

This visual representation captures the essential characteristic of linked lists. For economy, we use the term *links* to refer to node references. For simplicity, when item values are strings (as in our examples), we put the string within the object rectangle rather than the more accurate rendition depicting the string object and the character array that we discussed in SECTION 1.2. This visual representation allows us to focus on the links.

Insert at the beginning. First, suppose that you want to insert a new node into a linked list. The easiest place to do so is at the beginning of the list. For example, to insert the string *not* at the beginning of a given linked list whose first node is *first*, we save *first* in *oldfirst*, assign to *first* a new *Node*, and assign its *item* field to *not* and its *next* field to *oldfirst*. This code for inserting a node at the beginning of a linked list involves just a few assignment statements, so the amount of time that it takes is independent of the length of the list.

save a link to the list

```
Node oldfirst = first;
```

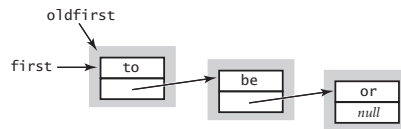

create a new node for the beginning

```
first = new Node();
```

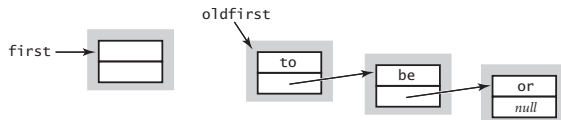

set the instance variables in the new node

```
first.item = "not";
first.next = oldfirst;
```

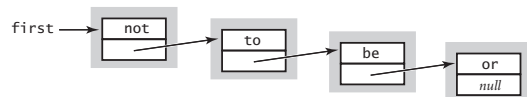

Inserting a new node at the beginning of a linked list

Remove from the beginning. Next, suppose that you want to remove the first node from a list. This operation is even easier: simply assign to `first` the value `first.next`. Normally, you would retrieve the value of the item (by assigning it to some variable of type `Item`) before doing this assignment, because once you change the value of `first`, you may not have any access to the node to which it was referring. Typically, the node object becomes an orphan, and the Java memory management system eventually reclaims the memory it occupies. Again, this operation just involves one assignment statement, so its running time is independent of the length of the list.

Insert at the end. How do we add a node to the *end* of a linked list? To do so, we need a link to the last node in the list, because that node's link has to be changed to reference a new node containing the item to be inserted. Maintaining an extra link is not something that should be taken lightly in linked-list code, because every method that modifies the list needs code to check whether that variable needs to be modified (and to make the necessary modifications). For example, the code that we just examined for removing the first node in the list might involve changing the reference to the last node in the list, since when there is only one node in the list, it is both the first one and the last one! Also, this code does not work (it follows a null link) in the case that the list is empty. Details like these make linked-list code notoriously difficult to debug.

Insert/remove at other positions. In summary, we have shown that we can implement the following operations on linked lists with just a few instructions, provided that we have access to both a link `first` to the first element in the list and a link `last` to the last element in the list:

- Insert at the beginning.
- Remove from the beginning.
- Insert at the end.

```
first = first.next;
```

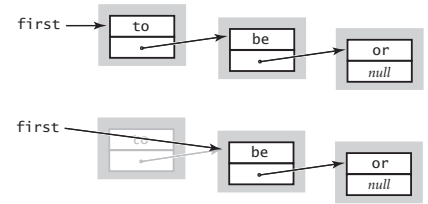

Removing the first node in a linked list

save a link to the last node

```
Node oldlast = last;
```

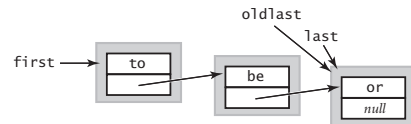

create a new node for the end

```
Node last = new Node();
last.item = "not";
```

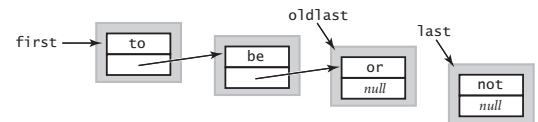

link the new node to the end of the list

```
oldlast.next = last;
```

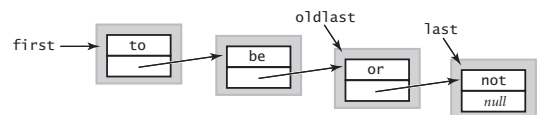

Inserting a new node at the end of a linked list

Other operations, such as the following, are not so easily handled:

- Remove a given node.
- Insert a new node before a given node.

For example, how can we remove the last node from a list? The link `last` is no help, because we need to set the link in the previous node in the list (the one with the same value as `last`) to `null`. In the absence of any other information, the only solution is to traverse the entire list looking for the node that links to `last` (see below and EXERCISE 1.3.19). Such a solution is undesirable because it takes time proportional to the length of the list. The standard solution to enable arbitrary insertions and deletions is to use a *doubly-linked list*, where each node has two links, one in each direction. We leave the code for these operations as an exercise (see EXERCISE 1.3.31). We do not need doubly linked lists for any of our implementations.

Traversal. To examine every item in an array, we use familiar code like the following loop for processing the items in an array `a[]`:

```
for (int i = 0; i < N; i++)
{
    // Process a[i].
}
```

There is a corresponding idiom for examining the items in a linked list: We initialize a loop index variable `x` to reference the first `Node` of the linked list. Then we find the item associated with `x` by accessing `x.item`, and then update `x` to refer to the next `Node` in the linked list, assigning to it the value of `x.next` and repeating this process until `x` is `null` (which indicates that we have reached the end of the linked list). This process is known as *traversing* the list and is succinctly expressed in code like the following loop for processing the items in a linked list whose first item is associated with the variable `first`:

```
for (Node x = first; x != null; x = x.next)
{
    // Process x.item.
}
```

This idiom is as natural as the standard idiom for iterating through the items in an array. In our implementations, we use it as the basis for iterators for providing client code the capability of iterating through the items, without having to know the details of the linked-list implementation.

Stack implementation. Given these preliminaries, developing an implementation for our Stack API is straightforward, as shown in ALGORITHM 1.2 on page 149. It maintains the stack as a linked list, with the top of the stack at the beginning, referenced by an instance variable `first`. Thus, to `push()` an item, we add it to the beginning of the list, using the code discussed on page 144 and to `pop()` an item, we remove it from the beginning of the list, using the code discussed on page 145. To implement `size()`, we keep track of the number of items in an instance variable `N`, incrementing `N` when we push and decrementing `N` when we pop. To implement `isEmpty()` we check whether `first` is `null` (alternatively, we could check whether `N` is 0). The implementation uses the generic type `Item`—you can think of the code `<Item>` after the class name as meaning that any occurrence of `Item` in the implementation will be replaced by a client-supplied data-type name (see page 134). For now, we omit the code to support iteration, which we consider on page 155. A trace for the test client that we have been using is shown on the next page. This use of linked lists achieves our optimum design goals:

- It can be used for any type of data.
- The space required is always proportional to the size of the collection.
- The time per operation is always independent of the size of the collection.

This implementation is a prototype for many *algorithm* implementations that we consider. It defines the linked-list *data structure* and implements the client methods `push()` and `pop()` that achieve the specified effect with just a few lines of code. The algorithms and data structure go hand in hand. In this case, the code for the algorithm implementations is quite simple, but the properties of the data structure are not at all elementary, requiring explanations on the past several pages. This interaction between data structure definition and algorithm implementation is typical and is our focus in ADT implementations throughout this book.

```
public static void main(String[] args)
{ // Create a stack and push/pop strings as directed on StdIn.
    Stack<String> s = new Stack<String>();
    while (!StdIn.isEmpty())
    {
        String item = StdIn.readString();
        if (!item.equals("-"))
            s.push(item);
        else if (!s.isEmpty()) StdOut.print(s.pop() + " ");
    }
    StdOut.println("(" + s.size() + " left on stack)");
}
```

Test client for Stack

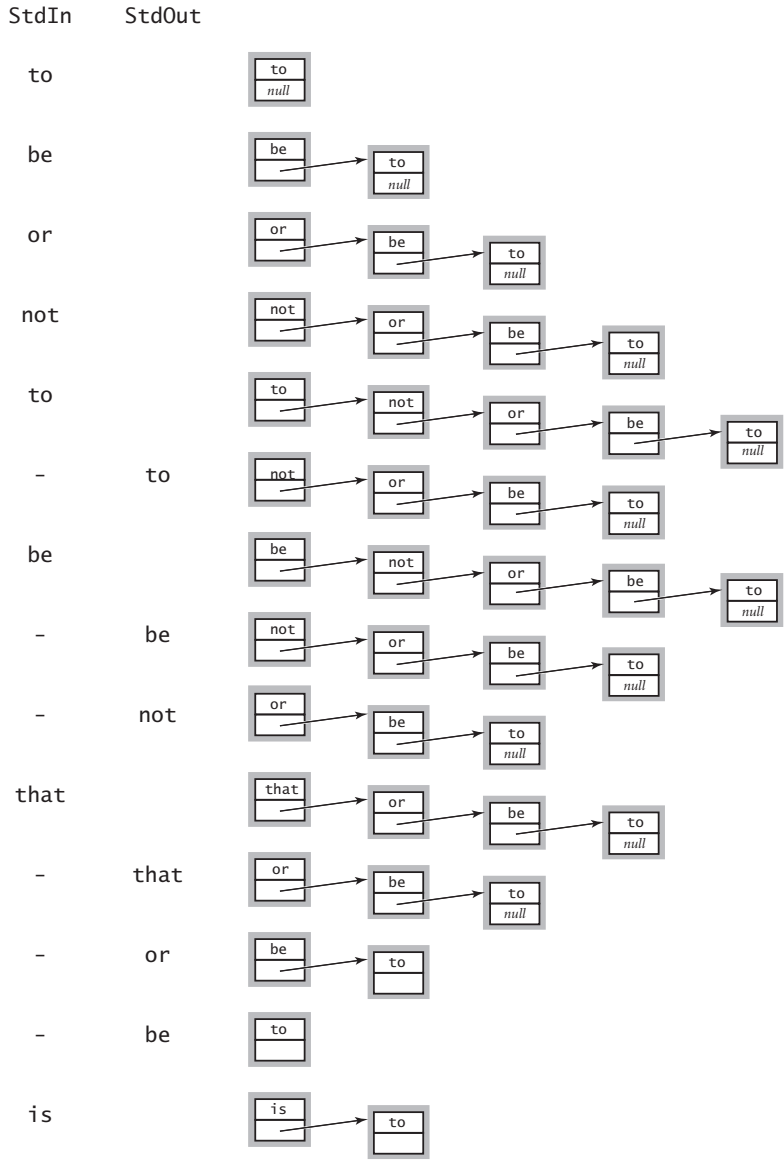

Trace of Stack development client

ALGORITHM 1.2 Pushdown stack (linked-list implementation)

```

public class Stack<Item> implements Iterable<Item>
{
    private Node first; // top of stack (most recently added node)
    private int N;      // number of items

    private class Node
    { // nested class to define nodes
        Item item;
        Node next;
    }

    public boolean isEmpty() { return first == null; } // Or: N == 0.
    public int size()       { return N; }

    public void push(Item item)
    { // Add item to top of stack.
        Node oldfirst = first;
        first = new Node();
        first.item = item;
        first.next = oldfirst;
        N++;
    }

    public Item pop()
    { // Remove item from top of stack.
        Item item = first.item;
        first = first.next;
        N--;
        return item;
    }

    // See page 155 for iterator() implementation.
    // See page 147 for test client main().
}

```

This generic Stack implementation is based on a linked-list data structure. It can be used to create stacks containing any type of data. To support iteration, add the highlighted code described for Bag on page 155.

```

% more tobe.txt
to be or not to - be - - that - - - is

% java Stack < tobe.txt
to be not that or be (2 left on stack)

```

Queue implementation. An implementation of our Queue API based on the linked-list data structure is also straightforward, as shown in ALGORITHM 1.3 on the facing page. It maintains the queue as a linked list in order from least recently to most recently added items, with the beginning of the queue referenced by an instance variable `first` and the end of the queue referenced by an instance variable `last`. Thus, to `enqueue()` an item, we add it to the end of the list (using the code discussed on page 145, augmented to set both `first` and `last` to refer to the new node when the list is empty) and to `dequeue()` an item, we remove it from the beginning of the list (using the same code as for `pop()` in `Stack`, augmented to update `last` when the list becomes empty). The implementations of `size()` and `isEmpty()` are the same as for `Stack`. As with `Stack` the implementation uses the generic type parameter `Item`, and we omit the code to support iteration, which we consider in our `Bag` implementation on page 155. A development client similar to the one we used for `Stack` is shown below, and the trace for this client is shown on the following page. This implementation uses the same *data structure* as does `Stack`—a linked list—but it implements different *algorithms* for adding and removing items, which make the difference between LIFO and FIFO for the client. Again, the use of linked lists achieves our optimum design goals: it can be used for any type of data, the space required is proportional to the number of items in the collection, and the time required per operation is always independent of the size of the collection.

```
public static void main(String[] args)
{ // Create a queue and enqueue/dequeue strings.
  Queue<String> q = new Queue<String>();
  while (!StdIn.isEmpty())
  {
    String item = StdIn.readString();
    if (!item.equals("-"))
      q.enqueue(item);
    else if (!q.isEmpty()) StdOut.print(q.dequeue() + " ");
  }
  StdOut.println("(" + q.size() + " left on queue)");
}
```

Test client for Queue

```
% more tobe.txt
to be or not to - be - - that - - - is
% java Queue < tobe.txt
to be or not to be (2 left on queue)
```

ALGORITHM 1.3 FIFO queue

```

public class Queue<Item> implements Iterable<Item>
{
    private Node first; // link to least recently added node
    private Node last;  // link to most recently added node
    private int N;      // number of items on the queue

    private class Node
    { // nested class to define nodes
        Item item;
        Node next;
    }

    public boolean isEmpty() { return first == null; } // Or: N == 0.
    public int size()       { return N; }

    public void enqueue(Item item)
    { // Add item to the end of the list.
        Node oldlast = last;
        last = new Node();
        last.item = item;
        last.next = null;
        if (isEmpty()) first = last;
        else            oldlast.next = last;
        N++;
    }

    public Item dequeue()
    { // Remove item from the beginning of the list.
        Item item = first.item;
        first = first.next;
        if (isEmpty()) last = null;
        N--;
        return item;
    }

    // See page 155 for iterator() implementation.
    // See page 150 for test client main().
}

```

This generic Queue implementation is based on a linked-list data structure. It can be used to create queues containing any type of data. To support iteration, add the highlighted code described for Bag on page 155.

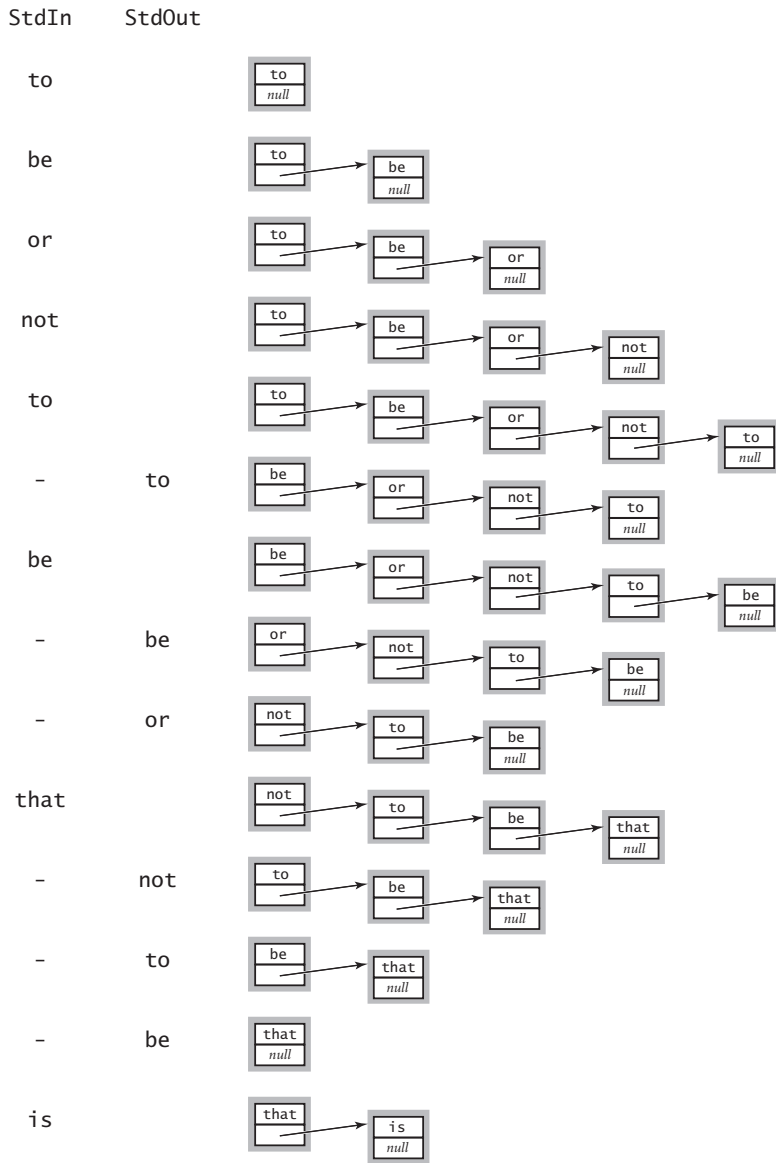

Trace of Queue development client

LINKED LISTS ARE A FUNDAMENTAL ALTERNATIVE to arrays for structuring a collection of data. From a historical perspective, this alternative has been available to programmers for many decades. Indeed, a landmark in the history of programming languages was the development of LISP by John McCarthy in the 1950s, where linked lists are the primary structure for programs and data. Programming with linked lists presents all sorts of challenges and is notoriously difficult to debug, as you can see in the exercises. In modern code, the use of safe pointers, automatic garbage collection (see page 111), and ADTs allows us to encapsulate list-processing code in just a few classes such as the ones presented here.

Bag implementation. Implementing our Bag API using a linked-list data structure is simply a matter of changing the name of `push()` in `Stack` to `add()` and removing the implementation of `pop()`, as shown in ALGORITHM 1.4 on the facing page (doing the same for `Queue` would also be effective but requires a bit more code). This implementation also highlights the code needed to make `Stack`, `Queue`, and `Bag` all iterable, by traversing the list. For `Stack` the list is in LIFO order; for `Queue` it is in FIFO order; and for `Bag` it happens to be in LIFO order, but the order is not relevant. As detailed in the highlighted code in ALGORITHM 1.4, to implement iteration in a collection, the first step is to include

```
import java.util.Iterator;
```

so that our code can refer to Java's `Iterator` interface. The second step is to add

```
implements Iterable<Item>
```

to the class declaration, a promise to provide an `iterator()` method. The `iterator()` method itself simply returns an object from a class that implements the `Iterator` interface:

```
public Iterator<Item> iterator()  
{ return new ListIterator(); }
```

This code is a promise to implement a class that implements the `hasNext()`, `next()`, and `remove()` methods that are called when a client uses the *foreach* construct. To implement these methods, the nested class `ListIterator` in ALGORITHM 1.4 maintains an instance variable `current` that keeps track of the current node on the list. Then the `hasNext()` method tests if `current` is `null`, and the `next()` method saves a reference to the current item, updates `current` to refer to the next node on the list, and returns the saved reference.

ALGORITHM 1.4 Bag

```

import java.util.Iterator;
public class Bag<Item> implements Iterable<Item>
{
    private Node first; // first node in list
    private class Node
    {
        Item item;
        Node next;
    }
    public void add(Item item)
    { // same as push() in Stack
        Node oldfirst = first;
        first = new Node();
        first.item = item;
        first.next = oldfirst;
    }
    public Iterator<Item> iterator()
    { return new ListIterator(); }
    private class ListIterator implements Iterator<Item>
    {
        private Node current = first;
        public boolean hasNext()
        { return current != null; }
        public void remove() { }
        public Item next()
        {
            Item item = current.item;
            current = current.next;
            return item;
        }
    }
}

```

This Bag implementation maintains a linked list of the items provided in calls to `add()`. Code for `isEmpty()` and `size()` is the same as in Stack and is omitted. The iterator traverses the list, maintaining the current node in `current`. We can make Stack and Queue iterable by adding the code highlighted in red to ALGORITHMS 1.1 and 1.2, because they use the same underlying data structure and Stack and Queue maintain the list in LIFO and FIFO order, respectively.

Overview The implementations of bags, queues, and stacks that support generics and iteration that we have considered in this section provide a level of abstraction that allows us to write compact client programs that manipulate collections of objects. Detailed understanding of these ADTs is important as an introduction to the study of algorithms and data structures for three reasons. First, we use these data types as building blocks in higher-level data structures throughout this book. Second, they illustrate the interplay between data structures and algorithms and the challenge of simultaneously achieving natural performance goals that may conflict. Third, the focus of several of our implementations is on ADTs that support more powerful operations on collections of objects, and we use the implementations here as starting points.

Data structures. We now have two ways to represent collections of objects, arrays and linked lists. Arrays are built in to Java; linked lists are easy to build with standard Java records. These two alternatives, often referred to as *sequential allocation* and *linked allocation*, are fundamental. Later in the book, we develop ADT implementations that

combine and extend these basic structures in numerous ways. One important extension is to data structures with multiple links. For example, our focus in SECTIONS 3.2 and 3.3 is on data structures known as *binary trees* that are built from nodes that each have *two* links. Another important extension is to *compose* data structures: we can have a bag of stacks, a queue of arrays, and so forth. For example, our focus in CHAPTER 4 is on graphs, which we represent as arrays of bags. It is very easy to define data structures of arbitrary complexity in this way: one important reason for our focus on abstract data types is an attempt to control such complexity.

data structure	advantage	disadvantage
<i>array</i>	index provides immediate access to any item	need to know size on initialization
<i>linked list</i>	uses space proportional to size	need reference to access an item

Fundamental data structures

It is very easy to define data structures of arbitrary complexity in this way: one important reason for our focus on abstract data types is an attempt to control such complexity.

OUR TREATMENT OF BAGS, QUEUES, AND STACKS in this section is a prototypical example of the approach that we use throughout this book to describe data structures and algorithms. In approaching a new applications domain, we identify computational challenges and use data abstraction to address them, proceeding as follows:

- Specify an API.
- Develop client code with reference to specific applications.
- Describe a data structure (representation of the set of values) that can serve as the basis for the *instance variables* in a class that will implement an ADT that meets the specification in the API.
- Describe algorithms (approaches to implementing the set of operations) that can serve as the basis for implementing the *instance methods* in the class.
- Analyze the performance characteristics of the algorithms.

In the next section, we consider this last step in detail, as it often dictates which algorithms and implementations can be most useful in addressing real-world applications.

data structure	section	ADT	representation
<i>parent-link tree</i>	1.5	UnionFind	array of integers
<i>binary search tree</i>	3.2, 3.3	BST	two links per node
<i>string</i>	5.1	String	array, offset, and length
<i>binary heap</i>	2.4	PQ	array of objects
<i>hash table (separate chaining)</i>	3.4	SeparateChainingHashST	arrays of linked lists
<i>hash table (linear probing)</i>	3.4	LinearProbingHashST	two arrays of objects
<i>graph adjacency lists</i>	4.1, 4.2	Graph	array of Bag objects
<i>trie</i>	5.2	TrieST	node with array of links
<i>ternary search trie</i>	5.3	TST	three links per node

Examples of data structures developed in this book

Q&A

Q. Not all programming languages have generics, even early versions of Java. What are the alternatives?

A. One alternative is to maintain a different implementation for each type of data, as mentioned in the text. Another is to build a stack of `Object` values, then cast to the desired type in client code for `pop()`. The problem with this approach is that type mismatch errors cannot be detected until run time. But with generics, if you write code to push an object of the wrong type on the stack, like this:

```
Stack<Apple> stack = new Stack<Apple>();
Apple a = new Apple();
...
Orange b = new Orange();
...
stack.push(a);
...
stack.push(b);    // compile-time error
```

you will get a compile-time error:

```
push(Apple) in Stack<Apple> cannot be applied to (Orange)
```

This ability to discover such errors at compile time is reason enough to use generics.

Q. Why does Java disallow generic arrays?

A. Experts still debate this point. You might need to become one to understand it! For starters, learn about *covariant arrays* and *type erasure*.

Q. How do I create an array of stacks of strings?

A. Use a cast, such as the following:

```
Stack<String>[] a = (Stack<String>[]) new Stack[N];
```

Warning: This cast, in client code, is different from the one described on page 134. You might have expected to use `Object` instead of `Stack`. When using generics, Java checks for type safety at compile time, but throws away that information at run time, so it is left with `Stack<Object>[]` or just `Stack[]`, for short, which we must cast to `Stack<String>[]`.

Q. What happens if my program calls `pop()` for an empty stack?

A. It depends on the implementation. For our implementation on page 149, you will get a `NullPointerException`. In our implementations on the booksite, we throw a runtime exception to help users pinpoint the error. Generally, including as many such checks as possible is wise in code that is likely to be used by many people.

Q. Why do we care about resizing arrays, when we have linked lists?

A. We will see several examples of ADT implementations that need to use arrays to perform other operations that are not easily supported with linked lists. `ResizingArrayStack` is a model for keeping their memory usage under control.

Q. Why declare `Node` as a nested class? Why `private`?

A. By declaring the nested class `Node` to be `private`, we restrict access to methods and instance variables within the enclosing class. One characteristic of a `private` nested class is that its instance variables can be directly accessed from within the enclosing class but nowhere else, so there is no need to declare the instance variables `public` or `private`. *Note for experts:* A nested class that is not static is known as an *inner* class, so technically our `Node` classes are inner classes, though the ones that are not generic could be static.

Q. When I type `javac Stack.java` to run ALGORITHM 1.2 and similar programs, I find `Stack.class` and a file `Stack$Node.class`. What is the purpose of that second one?

A. That file is for the inner class `Node`. Java's naming convention is to use `$` to separate the name of the outer class from the inner class.

Q. Are there Java libraries for stacks and queues?

A. Yes and no. Java has a built-in library called `java.util.Stack`, but you should avoid using it when you want a stack. It has several additional operations that are not normally associated with a stack, e.g., getting the `i`th element. It also allows adding an element to the bottom of the stack (instead of the top), so it can implement a queue! Although having such extra operations may appear to be a bonus, it is actually a curse. We use data types not just as libraries of all the operations we can imagine, but also as a mechanism to precisely specify the operations we need. The prime benefit of doing so is that the system can prevent us from performing operations that we do not actually

Q & A *(continued)*

want. The `java.util.Stack` API is an example of a *wide interface*, which we generally strive to avoid.

Q. Should a client be allowed to insert `null` items onto a stack or queue?

A. This question arises frequently when implementing collections in Java. Our implementation (and Java's stack and queue libraries) do permit the insertion of `null` values.

Q. What should the `Stack` iterator do if the client calls `push()` or `pop()` during iterator?

A. Throw a `java.util.ConcurrentModificationException` to make it a *fail-fast iterator*. See 1.3.50.

Q. Can I use a *foreach* loop with arrays?

A. Yes (even though arrays do not implement the `Iterable` interface). The following one-liner prints out the command-line arguments:

```
public static void main(String[] args)
{ for (String s : args) StdOut.println(s); }
```

Q. Can I use a *foreach* loop with strings?

A. No. `String` does not implement `Iterable`.

Q. Why not have a single `Collection` data type that implements methods to add items, remove the most recently inserted, remove the least recently inserted, remove random, iterate, return the number of items in the collection, and whatever other operations we might desire? Then we could get them all implemented in a single class that could be used by many clients.

A. Again, this is an example of a *wide interface*. Java has such implementations in its `java.util.ArrayList` and `java.util.LinkedList` classes. One reason to avoid them is that it there is no assurance that all operations are implemented efficiently. Throughout this book, we use APIs as starting points for designing efficient algorithms and data structures, which is certainly easier to do for interfaces with just a few operations as opposed to an interface with many operations. Another reason to insist on narrow interfaces is that they enforce a certain discipline on client programs, which makes client code much easier to understand. If one client uses `Stack<String>` and another uses `Queue<Transaction>`, we have a good idea that the LIFO discipline is important to the first and the FIFO discipline is important to the second.

EXERCISES

1.3.1 Add a method `isFull()` to `FixedCapacityStackOfStrings`.

1.3.2 Give the output printed by `java Stack` for the input

```
it was - the best - of times - - - it was - the - -
```

1.3.3 Suppose that a client performs an intermixed sequence of (stack) *push* and *pop* operations. The push operations put the integers 0 through 9 in order onto the stack; the pop operations print out the return values. Which of the following sequence(s) could *not* occur?

- a. 4 3 2 1 0 9 8 7 6 5
- b. 4 6 8 7 5 3 2 9 0 1
- c. 2 5 6 7 4 8 9 3 1 0
- d. 4 3 2 1 0 5 6 7 8 9
- e. 1 2 3 4 5 6 9 8 7 0
- f. 0 4 6 5 3 8 1 7 2 9
- g. 1 4 7 9 8 6 5 3 0 2
- h. 2 1 4 3 6 5 8 7 9 0

1.3.4 Write a stack client `Parentheses` that reads in a text stream from standard input and uses a stack to determine whether its parentheses are properly balanced. For example, your program should print `true` for `[]{}{[(())]}` and `false` for `[()]`.

1.3.5 What does the following code fragment print when `N` is 50? Give a high-level description of what it does when presented with a positive integer `N`.

```
Stack<Integer> stack = new Stack<Integer>();
while (N > 0)
{
    stack.push(N % 2);
    N = N / 2;
}
for (int d : stack) StdOut.print(d);
StdOut.println();
```

Answer: Prints the binary representation of `N` (110010 when `N` is 50).

EXERCISES *(continued)*

1.3.6 What does the following code fragment do to the queue `q`?

```
Stack<String> stack = new Stack<String>();
while (!q.isEmpty())
    stack.push(q.dequeue());
while (!stack.isEmpty())
    q.enqueue(stack.pop());
```

1.3.7 Add a method `peek()` to `Stack` that returns the most recently inserted item on the stack (without popping it).

1.3.8 Give the contents and size of the array for `DoublingStackOfStrings` with the input

```
it was - the best - of times - - - it was - the - -
```

1.3.9 Write a program that takes from standard input an expression without left parentheses and prints the equivalent infix expression with the parentheses inserted. For example, given the input:

```
1 + 2 ) * 3 - 4 ) * 5 - 6 ) ) )
```

your program should print

```
( ( 1 + 2 ) * ( ( 3 - 4 ) * ( 5 - 6 ) ) )
```

1.3.10 Write a filter `InfixToPostfix` that converts an arithmetic expression from infix to postfix.

1.3.11 Write a program `EvaluatePostfix` that takes a postfix expression from standard input, evaluates it, and prints the value. (Piping the output of your program from the previous exercise to this program gives equivalent behavior to `Evaluate`.)

1.3.12 Write an iterable `Stack` *client* that has a static method `copy()` that takes a stack of strings as argument and returns a copy of the stack. *Note*: This ability is a prime example of the value of having an iterator, because it allows development of such functionality without changing the basic API.

1.3.13 Suppose that a client performs an intermixed sequence of (queue) *enqueue* and *dequeue* operations. The enqueue operations put the integers 0 through 9 in order onto

the queue; the dequeue operations print out the return value. Which of the following sequence(s) could *not* occur?

- a. 0 1 2 3 4 5 6 7 8 9
- b. 4 6 8 7 5 3 2 9 0 1
- c. 2 5 6 7 4 8 9 3 1 0
- d. 4 3 2 1 0 5 6 7 8 9

1.3.14 Develop a class `ResizingArrayQueueOfStrings` that implements the queue abstraction with a fixed-size array, and then extend your implementation to use array resizing to remove the size restriction.

1.3.15 Write a `Queue` client that takes a command-line argument `k` and prints the `k`th from the last string found on standard input (assuming that standard input has `k` or more strings).

1.3.16 Using `readInts()` on page 126 as a model, write a static method `readDates()` for `Date` that reads dates from standard input in the format specified in the table on page 119 and returns an array containing them.

1.3.17 Do EXERCISE 1.3.16 for `Transaction`.

LINKED-LIST EXERCISES

This list of exercises is intended to give you experience in working with linked lists. Suggestion: make drawings using the visual representation described in the text.

1.3.18 Suppose `x` is a linked-list node and not the last node on the list. What is the effect of the following code fragment?

```
x.next = x.next.next;
```

Answer: Deletes from the list the node immediately following `x`.

1.3.19 Give a code fragment that removes the last node in a linked list whose first node is `first`.

1.3.20 Write a method `delete()` that takes an `int` argument `k` and deletes the `k`th element in a linked list, if it exists.

1.3.21 Write a method `find()` that takes a linked list and a string key as arguments and returns `true` if some node in the list has key as its `item` field, `false` otherwise.

1.3.22 Suppose that `x` is a linked list `Node`. What does the following code fragment do?

```
t.next = x.next;  
x.next = t;
```

Answer: Inserts node `t` immediately after node `x`.

1.3.23 Why does the following code fragment not do the same thing as in the previous question?

```
x.next = t;  
t.next = x.next;
```

Answer: When it comes time to update `t.next`, `x.next` is no longer the original node following `x`, but is instead `t` itself!

1.3.24 Write a method `removeAfter()` that takes a linked-list `Node` as argument and removes the node following the given one (and does nothing if the argument or the next field in the argument node is null).

1.3.25 Write a method `insertAfter()` that takes two linked-list `Node` arguments and inserts the second after the first on its list (and does nothing if either argument is null).

1.3.26 Write a method `remove()` that takes a linked list and a string key as arguments and removes all of the nodes in the list that have key as its item field.

1.3.27 Write a method `max()` that takes a reference to the first node in a linked list as argument and returns the value of the maximum key in the list. Assume that all keys are positive integers, and return 0 if the list is empty.

1.3.28 Develop a recursive solution to the previous question.

1.3.29 Write a Queue implementation that uses a *circular* linked list, which is the same as a linked list except that no links are *null* and the value of `last.next` is `first` whenever the list is not empty. Keep only one Node instance variable (`last`).

1.3.30 Write a function that takes the first Node in a linked list as argument and (destructively) reverses the list, returning the first Node in the result.

Iterative solution: To accomplish this task, we maintain references to three consecutive nodes in the linked list, `reverse`, `first`, and `second`. At each iteration, we extract the node `first` from the original linked list and insert it at the beginning of the reversed list. We maintain the invariant that `first` is the first node of what's left of the original list, `second` is the second node of what's left of the original list, and `reverse` is the first node of the resulting reversed list.

```
public Node reverse(Node x)
{
    Node first = x;
    Node reverse = null;
    while (first != null)
    {
        Node second = first.next;
        first.next = reverse;
        reverse = first;
        first = second;
    }
    return reverse;
}
```

When writing code involving linked lists, we must always be careful to properly handle the exceptional cases (when the linked list is empty, when the list has only one or two

LINKED-LIST EXERCISES *(continued)*

nodes) and the boundary cases (dealing with the first or last items). This is usually much trickier than handling the normal cases.

Recursive solution: Assuming the linked list has N nodes, we recursively reverse the last $N-1$ nodes, and then carefully append the first node to the end.

```
public Node reverse(Node first)
{
    if (first == null) return null;
    if (first.next == null) return first;
    Node second = first.next;
    Node rest = reverse(second);
    second.next = first;
    first.next = null;
    return rest;
}
```

1.3.31 Implement a nested class `DoubleNode` for building doubly-linked lists, where each node contains a reference to the item preceding it and the item following it in the list (`null` if there is no such item). Then implement static methods for the following tasks: insert at the beginning, insert at the end, remove from the beginning, remove from the end, insert before a given node, insert after a given node, and remove a given node.

CREATIVE PROBLEMS

1.3.32 *Steque*. A stack-ended queue or *steque* is a data type that supports *push*, *pop*, and *enqueue*. Articulate an API for this ADT. Develop a linked-list-based implementation.

1.3.33 *Deque*. A double-ended queue or *deque* (pronounced “deck”) is like a stack or a queue but supports adding and removing items at both ends. A deque stores a collection of items and supports the following API:

```
public class Deque<Item> implements Iterable<Item>
    Deque()                create an empty deque
    boolean isEmpty()      is the deque empty?
    int size()             number of items in the deque
    void pushLeft(Item item) add an item to the left end
    void pushRight(Item item) add an item to the right end
    Item popLeft()         remove an item from the left end
    Item popRight()        remove an item from the right end
```

API for a generic double-ended queue

Write a class `Deque` that uses a doubly-linked list to implement this API and a class `ResizingArrayDeque` that uses a resizing array.

1.3.34 *Random bag*. A *random bag* stores a collection of items and supports the following API:

```
public class RandomBag<Item> implements Iterable<Item>
    RandomBag()            create an empty random bag
    boolean isEmpty()      is the bag empty?
    int size()             number of items in the bag
    void add(Item item)    add an item
```

API for a generic random bag

Write a class `RandomBag` that implements this API. Note that this API is the same as for `Bag`, except for the adjective *random*, which indicates that the iteration should provide

CREATIVE PROBLEMS *(continued)*

the items in *random* order (all $N!$ permutations equally likely, for each iterator). *Hint*: Put the items in an array and randomize their order in the iterator's constructor.

1.3.35 *Random queue.* A *random queue* stores a collection of items and supports the following API:

```
public class RandomQueue<Item>
{
    RandomQueue()           create an empty random queue
    boolean isEmpty()       is the queue empty?
    void enqueue(Item item) add an item
    Item dequeue()          remove and return a random item
                           (sample without replacement)
    Item sample()           return a random item, but do not remove
                           (sample with replacement)
}
```

API for a generic random queue

Write a class `RandomQueue` that implements this API. *Hint*: Use an array representation (with resizing). To remove an item, swap one at a random position (indexed 0 through $N-1$) with the one at the last position (index $N-1$). Then delete and return the last object, as in `ResizingArrayStack`. Write a client that deals bridge hands (13 cards each) using `RandomQueue<Card>`.

1.3.36 *Random iterator.* Write an iterator for `RandomQueue<Item>` from the previous exercise that returns the items in random order.

1.3.37 *Josephus problem.* In the Josephus problem from antiquity, N people are in dire straits and agree to the following strategy to reduce the population. They arrange themselves in a circle (at positions numbered from 0 to $N-1$) and proceed around the circle, eliminating every M th person until only one person is left. Legend has it that Josephus figured out where to sit to avoid being eliminated. Write a `Queue` client `Josephus` that takes N and M from the command line and prints out the order in which people are eliminated (and thus would show Josephus where to sit in the circle).

```
% java Josephus 7 2
1 3 5 0 4 2 6
```

1.3.38 *Delete kth element.* Implement a class that supports the following API:

```
public class GeneralizedQueue<Item>
{
    GeneralizedQueue() create an empty queue
    boolean isEmpty() is the queue empty?
    void insert(Item x) add an item
    Item delete(int k) delete and return the kth least recently inserted item
}
```

API for a generic generalized queue

First, develop an implementation that uses an array implementation, and then develop one that uses a linked-list implementation. *Note:* the algorithms and data structures that we introduce in CHAPTER 3 make it possible to develop an implementation that can guarantee that both `insert()` and `delete()` take time proportional to the logarithm of the number of items in the queue—see EXERCISE 3.5.27.

1.3.39 *Ring buffer.* A ring buffer, or circular queue, is a FIFO data structure of a fixed size N . It is useful for transferring data between asynchronous processes or for storing log files. When the buffer is empty, the consumer waits until data is deposited; when the buffer is full, the producer waits to deposit data. Develop an API for a `RingBuffer` and an implementation that uses an array representation (with circular wrap-around).

1.3.40 *Move-to-front.* Read in a sequence of characters from standard input and maintain the characters in a linked list with no duplicates. When you read in a previously unseen character, insert it at the front of the list. When you read in a duplicate character, delete it from the list and reinsert it at the beginning. Name your program `MoveToFront`: it implements the well-known *move-to-front* strategy, which is useful for caching, data compression, and many other applications where items that have been recently accessed are more likely to be reaccessed.

1.3.41 *Copy a queue.* Create a new constructor so that

```
Queue<Item> r = new Queue<Item>(q);
```

makes `r` a reference to a new and independent copy of the queue `q`. You should be able to push and pop from either `q` or `r` without influencing the other. *Hint:* Delete all of the elements from `q` and add these elements to both `q` and `r`.

CREATIVE PROBLEMS *(continued)*

1.3.42 *Copy a stack.* Create a new constructor for the linked-list implementation of `Stack` so that

```
Stack<Item> t = new Stack<Item>(s);
```

makes `t` a reference to a new and independent copy of the stack `s`.

1.3.43 *Listing files.* A folder is a list of files and folders. Write a program that takes the name of a folder as a command-line argument and prints out all of the files contained in that folder, with the contents of each folder recursively listed (indented) under that folder's name. *Hint:* Use a queue, and see `java.io.File`.

1.3.44 *Text editor buffer.* Develop a data type for a buffer in a text editor that implements the following API:

```
public class Buffer
```

<code>Buffer()</code>	<i>create an empty buffer</i>
<code>void insert(char c)</code>	<i>insert c at the cursor position</i>
<code>char delete()</code>	<i>delete and return the character at the cursor</i>
<code>void left(int k)</code>	<i>move the cursor k positions to the left</i>
<code>void right(int k)</code>	<i>move the cursor k positions to the right</i>
<code>int size()</code>	<i>number of characters in the buffer</i>

API for a text buffer

Hint: Use two stacks.

1.3.45 *Stack generability.* Suppose that we have a sequence of intermixed *push* and *pop* operations as with our test stack client, where the integers 0, 1, ..., $N-1$ in that order (*push* directives) are intermixed with N minus signs (*pop* directives). Devise an algorithm that determines whether the intermixed sequence causes the stack to underflow. (You may use only an amount of space independent of N —you cannot store the integers in a data structure.) Devise a linear-time algorithm that determines whether a given permutation can be generated as output by our test client (depending on where the *pop* directives occur).

Solution: The stack does not overflow unless there exists an integer k such that the first k pop operations occur before the first k push operations. If a given permutation can be generated, it is uniquely generated as follows: if the next integer in the output permutation is in the top of the stack, pop it; otherwise, push it onto the stack.

1.3.46 *Forbidden triple for stack generability.* Prove that a permutation can be generated by a stack (as in the previous question) if and only if it has no forbidden triple (a, b, c) such that $a < b < c$ with c first, a second, and b third (possibly with other intervening integers between c and a and between a and b).

Partial solution: Suppose that there is a forbidden triple (a, b, c) . Item c is popped before a and b , but a and b are pushed before c . Thus, when c is pushed, both a and b are on the stack. Therefore, a cannot be popped before b .

1.3.47 *Catenable queues, stacks, or steques.* Add an extra operation *catenation* that (destructively) concatenates two queues, stacks, or steques (see EXERCISE 1.3.32). *Hint:* Use a circular linked list, maintaining a pointer to the last item.

1.3.48 *Two stacks with a deque.* Implement two stacks with a single deque so that each operation takes a constant number of deque operations (see EXERCISE 1.3.33).

1.3.49 *Queue with three stacks.* Implement a queue with three stacks so that each queue operation takes a constant (worst-case) number of stack operations. *Warning:* high degree of difficulty.

1.3.50 *Fail-fast iterator.* Modify the iterator code in Stack to immediately throw a `java.util.ConcurrentModificationException` if the client modifies the collection (via `push()` or `pop()`) during iteration? *b*).

Solution: Maintain a counter that counts the number of `push()` and `pop()` operations. When creating an iterator, store this value as an `Iterator` instance variable. Before each call to `hasNext()` and `next()`, check that this value has not changed since construction of the iterator; if it has, throw the exception.

1.4 ANALYSIS OF ALGORITHMS

AS PEOPLE GAIN EXPERIENCE USING COMPUTERS, they use them to solve difficult problems or to process large amounts of data and are invariably led to questions like these:

How long will my program take?

Why does my program run out of memory?

You certainly have asked yourself these questions, perhaps when rebuilding a music or photo library, installing a new application, working with a large document, or working with a large amount of experimental data. The questions are much too vague to be answered precisely—the answers depend on many factors such as properties of the particular computer being used, the particular data being processed, and the particular program that is doing the job (which implements some algorithm). All of these factors leave us with a daunting amount of information to analyze.

Despite these challenges, the path to developing useful answers to these basic questions is often remarkably straightforward, as you will see in this section. This process is based on the *scientific method*, the commonly accepted body of techniques used by scientists to develop knowledge about the natural world. We apply *mathematical analysis* to develop concise models of costs and do *experimental studies* to validate these models.

Scientific method The very same approach that scientists use to understand the natural world is effective for studying the running time of programs:

- *Observe* some feature of the natural world, generally with precise measurements.
- *Hypothesize* a model that is consistent with the observations.
- *Predict* events using the hypothesis.
- *Verify* the predictions by making further observations.
- *Validate* by repeating until the hypothesis and observations agree.

One of the key tenets of the scientific method is that the experiments we design must be *reproducible*, so that others can convince themselves of the validity of the hypothesis. Hypotheses must also be *falsifiable*, so that we can know for sure when a given hypothesis is wrong (and thus needs revision). As Einstein famously is reported to have said (“*No amount of experimentation can ever prove me right; a single experiment can prove me wrong*”), we can never know for sure that any hypothesis is absolutely correct; we can only validate that it is consistent with our observations.

Observations Our first challenge is to determine how to make quantitative measurements of the running time of our programs. This task is far easier than in the natural sciences. We do not have to send a rocket to Mars or kill laboratory animals or split an atom—we can simply run the program. Indeed, *every* time you run a program, you are performing a scientific experiment that relates the program to the natural world and answers one of our core questions: *How long will my program take?*

Our first qualitative observation about most programs is that there is a *problem size* that characterizes the difficulty of the computational task. Normally, the problem size is either the size of the input or the value of a command-line argument. Intuitively, the running time should increase with problem size, but the question of *by how much* it increases naturally comes up every time we develop and run a program.

Another qualitative observation for many programs is that the running time is relatively insensitive to the input itself; it depends primarily on the problem size. If this relationship does not hold, we need to take steps to better understand and perhaps better control the running time's sensitivity to the input. But it does often hold, so we now focus on the goal of better quantifying the relationship between problem size and running time.

Example. As a running example, we will work with the program `ThreeSum` shown here, which counts the number of triples in a file of N integers that sum to 0 (assuming that overflow plays no role). This computation may seem contrived to you, but it is deeply related to numerous fundamental computational tasks (for example, see EXERCISE 1.4.26). As a test input, consider the file `1Mints.txt` from the booksite, which contains 1 million randomly generated `int` values. The second, eighth, and tenth entries in `1Mints.txt` sum to 0. How many more such triples are there in the file? `ThreeSum` can tell us, but can it do so in a reasonable amount of time? What is the relationship between the problem size N and running time for `ThreeSum`? As a first experiment, try running `ThreeSum` on your computer for the files `1Kints.txt`, `2Kints.txt`, `4Kints.txt`, and `8Kints.txt` on the

```
public class ThreeSum
{
    public static int count(int[] a)
    { // Count triples that sum to 0.
        int N = a.length;
        int cnt = 0;
        for (int i = 0; i < N; i++)
            for (int j = i+1; j < N; j++)
                for (int k = j+1; k < N; k++)
                    if (a[i] + a[j] + a[k] == 0)
                        cnt++;
        return cnt;
    }

    public static void main(String[] args)
    {
        int[] a = In.readInts(args[0]);
        StdOut.println(count(a));
    }
}
```

Given N , how long will this program take?

```
% more 1Mints.txt
324110
-442472
626686
-157678
508681
123414
-77867
155091
129801
287381
604242
686904
-247109
77867
982455
-210707
-922943
-738817
85168
855430
...
```

booksite that contain the first 1,000, 2,000, 4,000, and 8,000 integers from 1Mints.txt, respectively. You can quickly determine that there are 70 triples that sum to 0 in 1Kints.txt and that there are 528 triples that sum to 0 in 2Kints.txt. The program takes substantially more time to determine that there are 4,039 triples that sum to 0 in 4Kints.txt, and as you wait for the program to finish for 8Kints.txt, you will find yourself asking the question *How long will my program take?* As you will see, answering this question for this program turns out to be easy. Indeed, you can often come up with a fairly accurate prediction while the program is running.

Stopwatch. Reliably measuring the exact running time of a given program can be difficult. Fortunately, we are usually happy with estimates. We want to be able to distinguish programs that will finish in a few seconds or a few minutes from those that might

require a few days or a few months or more, and we want to know when one program is twice as fast as another for the same task. Still, we need accurate measurements to generate experimental data that we can use to formulate and to check the validity of hypotheses about the relationship between running time and problem size. For this purpose, we use the Stopwatch data type shown on the facing page. Its `elapsedTime()` method returns the elapsed time since it was created, in seconds. The implementation is based on using the Java system's `currentTimeMillis()` method, which gives the current time in milliseconds, to save the time when the constructor is invoked, then uses it again to compute the elapsed time when `elapsedTime()` is invoked.

% java ThreeSum 1000 1Kints.txt



70

% java ThreeSum 2000 2Kints.txt

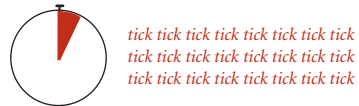

528

% java ThreeSum 4000 4Kints.txt

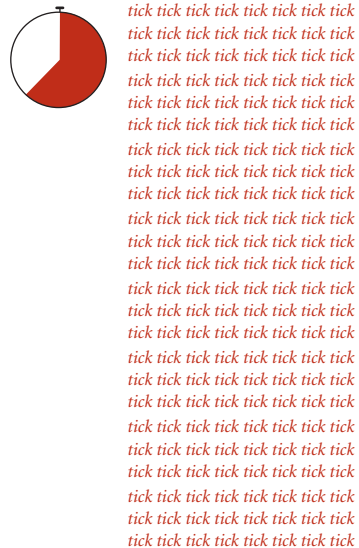

4039

Observing the running time of a program

API `public class Stopwatch`

`Stopwatch()` *create a stopwatch*
`double elapsedTime()` *return elapsed time since creation*

typical client

```
public static void main(String[] args)
{
    int N = Integer.parseInt(args[0]);
    int[] a = new int[N];
    for (int i = 0; i < N; i++)
        a[i] = StdRandom.uniform(-1000000, 1000000);
    Stopwatch timer = new Stopwatch();
    int cnt = ThreeSum.count(a);
    double time = timer.elapsedTime();
    StdOut.println(cnt + " triples " + time);
}
```

application

```
% java Stopwatch 1000
51 triples 0.488 seconds

% java Stopwatch 2000
516 triples 3.855 seconds
```

implementation

```
public class Stopwatch
{
    private final long start;

    public Stopwatch()
    { start = System.currentTimeMillis(); }

    public double elapsedTime()
    {
        long now = System.currentTimeMillis();
        return (now - start) / 1000.0;
    }
}
```

An abstract data type for a stopwatch

Analysis of experimental data. The program `DoublingTest` on the facing page is a more sophisticated `Stopwatch` client that produces experimental data for `ThreeSum`. It generates a sequence of random input arrays, doubling the array size at each step, and prints the running times of `ThreeSum.count()` for each input size. These experiments are certainly reproducible—you can also run them on your own computer, as many times as you like. When you run `DoublingTest`, you will find yourself in a prediction-verification cycle: it prints several lines very quickly, but then slows down considerably. Each time it prints a line, you find yourself wondering how long it will be until it prints the next line. Of course, since you have a different computer from ours, the actual running times that you get are likely to be different from those shown for our computer. Indeed, if your computer is twice as fast as ours, your running times will be about half ours, which leads immediately to the well-founded hypothesis that running times on different computers are likely to differ by a constant factor. Still, you will find yourself asking the more detailed question *How long will my program take, as a function of the input size?* To help answer this question, we plot the data. The diagrams at the bottom of the facing page show the result of plotting the data, both on a normal and on a log-log scale, with the problem size N on the x -axis and the running time $T(N)$ on the y -axis. The log-log plot immediately leads to a hypothesis about the running time—the data fits a straight line of slope 3 on the log-log plot. The equation of such a line is

$$\lg(T(N)) = 3 \lg N + \lg a$$

(where a is a constant) which is equivalent to

$$T(N) = aN^3$$

the running time, as a function of the input size, as desired. We can use one of our data points to solve for a —for example, $T(8000) = 51.1 = a8000^3$, so $a = 9.98 \times 10^{-11}$ —and then use the equation

$$T(N) = 9.98 \times 10^{-11} N^3$$

to predict running times for large N . Informally, we are checking the hypothesis that the data points on the log-log plot fall close to this line. Statistical methods are available for doing a more careful analysis to find estimates of a and the exponent b , but our quick calculations suffice to estimate running time for most purposes. For example, we can estimate the running time on our computer for $N = 16,000$ to be about $9.98 \times 10^{-11} 16000^3 = 408.8$ seconds, or about 6.8 minutes (the actual time was 409.3 seconds). While waiting for your computer to print the line for $N = 16,000$ in `DoublingTest`, you might use this method to predict when it will finish, then check the result by waiting to see if your prediction is true.

program to perform experiments

```

public class DoublingTest
{
    public static double timeTrial(int N)
    { // Time ThreeSum.count() for N random 6-digit ints.
      int MAX = 1000000;
      int[] a = new int[N];
      for (int i = 0; i < N; i++)
          a[i] = StdRandom.uniform(-MAX, MAX);
      Stopwatch timer = new Stopwatch();
      int cnt = ThreeSum.count(a);
      return timer.elapsedTime();
    }

    public static void main(String[] args)
    { // Print table of running times.
      for (int N = 250; true; N += N)
      { // Print time for problem size N.
        double time = timeTrial(N);
        StdOut.printf("%7d %5.1f\n", N, time);
      }
    }
}

```

results of experiments

```

% java DoublingTest
   250  0.0
   500  0.0
  1000  0.1
  2000  0.8
  4000  6.4
  8000 51.1
  ...

```

standard plot

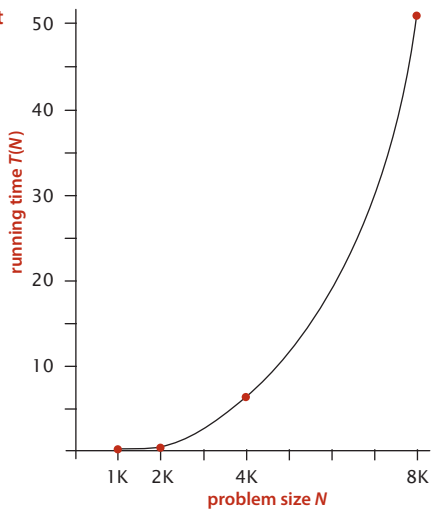

log-log plot

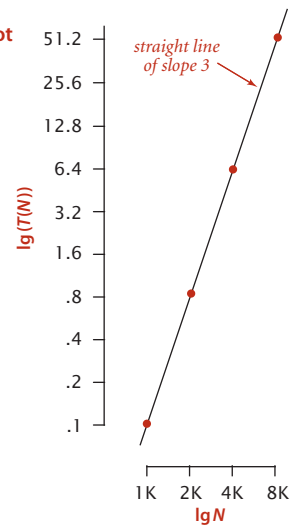

Analysis of experimental data (the running time of ThreeSum.count())

So far, this process mirrors the process scientists use when trying to understand properties of the real world. A straight line in a log-log plot is equivalent to the hypothesis that the data fits the equation $T(N) = aN^b$. Such a fit is known as a *power law*. A great many natural and synthetic phenomena are described by power laws, and it is reasonable to hypothesize that the running time of a program does, as well. Indeed, for the analysis of algorithms, we have mathematical models that strongly support this and similar hypotheses, to which we now turn.

Mathematical models In the early days of computer science, D. E. Knuth postulated that, despite all of the complicating factors in understanding the running times of our programs, it is possible, in principle, to build a mathematical model to describe the running time of any program. Knuth's basic insight is simple: the total running time of a program is determined by two primary factors:

- The cost of executing each statement
- The frequency of execution of each statement

The former is a property of the computer, the Java compiler and the operating system; the latter is a property of the program and the input. If we know both for all instructions in the program, we can multiply them together and sum for all instructions in the program to get the running time.

The primary challenge is to determine the frequency of execution of the statements. Some statements are easy to analyze: for example, the statement that sets `cnt` to 0 in `ThreeSum.count()` is executed exactly once. Others require higher-level reasoning: for example, the `if` statement in `ThreeSum.count()` is executed precisely

$$N(N-1)(N-2)/6$$

times (the number of ways to pick three different numbers from the input array—see EXERCISE 1.4.1). Others depend on the input data: for example the number of times the instruction `cnt++` in `ThreeSum.count()` is executed is precisely the number of triples that sum to 0 in the input, which could range from 0 of them to all of them. In the case of `DoublingTest`, where we generate the numbers randomly, it is possible to do a probabilistic analysis to determine the expected value of this quantity (see EXERCISE 1.4.40).

Tilde approximations. Frequency analyses of this sort can lead to complicated and lengthy mathematical expressions. For example, consider the count just considered of the number of times the `if` statement in `ThreeSum` is executed:

$$N(N-1)(N-2)/6 = N^3/6 - N^2/2 + N/3$$

As is typical in such expressions, the terms after the leading term are relatively small (for example, when $N = 1,000$ the value of $-N^2/2 + N/3$

$499,667$ is certainly insignificant by comparison with $N^3/6 \approx 166,666,667$). To allow us to ignore insignificant terms and therefore substantially simplify the mathematical formulas that we work with, we often use a mathematical device known as the *tilde notation* (\sim). This notation allows us to work with *tilde approximations*, where we throw away low-order terms that complicate formulas and represent a negligible contribution to values of interest:

Definition. We write $\sim f(N)$ to represent any function that, when divided by $f(N)$, approaches 1 as N grows, and we write $g(N) \sim f(N)$ to indicate that $g(N)/f(N)$ approaches 1 as N grows.

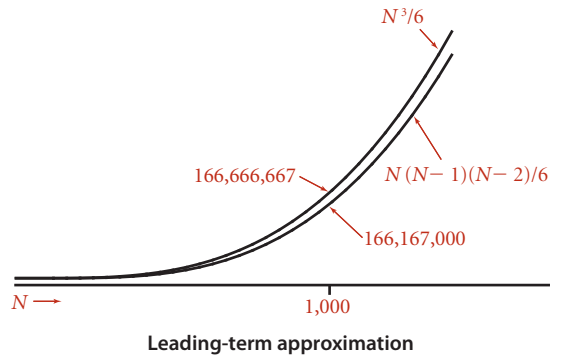

function	tilde approximation	order of growth
$N^3/6 - N^2/2 + N/3$	$\sim N^3/6$	N^3
$N^2/2 - N/2$	$\sim N^2/2$	N^2
$\lg N + 1$	$\sim \lg N$	$\lg N$
3	~ 3	1

Typical tilde approximations

description	function	order of growth
constant	1	
logarithmic	$\log N$	
linear	N	
linearithmic	$N \log N$	
quadratic	N^2	
cubic	N^3	
exponential	2^N	

Commonly encountered order-of-growth functions

For example, we use the approximation $\sim N^3/6$ to describe the number of times the `if` statement in `ThreeSum` is executed, since $N^3/6 - N^2/2 + N/3$ divided by $N^3/6$ approaches 1 as N grows. Most often, we work with tilde approximations of the form $g(N) \sim af(N)$ where $f(N) = N^b(\log N)^c$ with a , b , and c constants and refer to $f(N)$ as the *order of growth* of $g(N)$. When using the logarithm in the order of growth, we generally do not specify the base, since the constant a can absorb that detail. This usage covers the relatively few functions that are commonly encountered in studying the order of growth of a program's running time shown in the table at left (with the exception of the exponential, which we defer to `CONTEXT`). We will describe these functions in more detail and briefly discuss why they appear in the analysis of algorithms after we complete our treatment of `ThreeSum`.

Approximate running time. To follow through on Knuth's approach to develop a mathematical expression for the total running time of a Java program, we can (in principle) study our Java compiler to find the number of machine instructions corresponding to each Java instruction and study our machine specifications to find the time of execution of each of the machine instructions, to produce a grand total. This process, for `ThreeSum`, is briefly summarized on the facing page. We classify blocks of Java statements by their frequency of execution, develop leading-term approximations for the frequencies, determine the cost of each statement, and then compute a total. Note that some frequencies may depend on the input. In this case, the number of times `cnt++` is executed certainly depends on the input—it is the number of triples that sum to 0, and could range from 0 to $\sim N^3/6$. We stop short of exhibiting the details (values of the constants) for any particular system, except to highlight that by using constant values t_0, t_1, t_2, \dots for the time taken by the blocks of statements, we are assuming that each block of Java statements corresponds to machine instructions that require a specified fixed amount of time. A key observation from this exercise is to note that only the instructions that are executed the most frequently play a role in the final total—we refer to these instructions as the *inner loop* of the program. For `ThreeSum`, the inner loop is the statements that increment `k` and test that it is less than `N` and the statements that test whether the sum of three given numbers is 0 (and possibly the statement that implements the count, depending on the input). This behavior is typical: the running times of a great many programs depend only on a small subset of their instructions.

Order-of-growth hypothesis. In summary, the experiments on page 177 and the mathematical model on page 181 both support the following hypothesis:

Property A. The order of growth of the running time of `ThreeSum` (to compute the number of triples that sum to 0 among N numbers) is N^3 .

Evidence: Let $T(N)$ be the running time of `ThreeSum` for N numbers. The mathematical model just described suggests that $T(N) \sim aN^3$ for some machine-dependent constant a ; experiments on many computers (including yours and ours) validate that approximation.

Throughout this book, we use the term *property* to refer to a hypothesis that needs to be validated through experimentation. The end result of our mathematical analysis is precisely the same as the end result of our experimental analysis—the running time of `ThreeSum` is $\sim aN^3$ for a machine-dependent constant a . This match validates both the experiments and the mathematical model and also exhibits more insight about the

```

public class ThreeSum
{
    public static int count(int[] a)
    {
        A → int N = a.length;
           int cnt = 0;
           for (int i = 0; i < N; i++)
           B → for (int j = i+1; j < N; j++)
              C → for (int k = j+1; k < N; k++)
                 D → if (a[i] + a[j] + a[k] == 0)
                    E → cnt++;
           return cnt;
    }

    public static void main(String[] args)
    {
        int[] a = In.readInts(args[0]);
        StdOut.println(count(a));
    }
}

```

Anatomy of a program's statement execution frequencies

statement block	time in seconds	frequency	total time
E	t_0	x (depends on input)	$t_0 x$
D	t_1	$N^3/6 - N^2/2 + N/3$	$t_1 (N^3/6 - N^2/2 + N/3)$
C	t_2	$N^2/2 - N/2$	$t_2 (N^2/2 - N/2)$
B	t_3	N	$t_3 N$
A	t_4	1	t_4
		grand total	$(t_1/6) N^3$ $+ (t_2/2 - t_1/2) N^2$ $+ (t_1/3 - t_2/2 + t_3) N$ $+ t_4 + t_0 x$
		tilde approximation	$\sim (t_1 / 6) N^3$ (assuming x is small)
		order of growth	N^3

Analyzing the running time of a program (example)

program because it does not require experimentation to determine the exponent. With some effort, we could validate the value of a on a particular system as well, though that activity is generally reserved for experts in situations where performance is critical.

Analysis of algorithms. Hypotheses such as PROPERTY A are significant because they relate the abstract world of a Java program to the real world of a computer running it. Working with the order of growth allows us to take one further step: to separate a program from the algorithm it implements. The idea that the order of growth of the running time of `ThreeSum` is N^3 does not depend on the fact that it is implemented in Java or that it is running on your laptop or someone else's cellphone or a supercomputer; it depends primarily on the fact that it examines all the different triples of numbers in the input. The *algorithm* that you are using (and sometimes the input model) determines the order of growth. Separating the algorithm from the implementation on a particular computer is a powerful concept because it allows us to develop knowledge about the performance of algorithms and then apply that knowledge to any computer. For example, we might say that `ThreeSum` is an implementation of the brute-force algorithm “compute the sum of all different triples, counting those that sum to 0”—we expect that an implementation of this algorithm in any programming language on any computer will lead to a running time that is proportional to N^3 . In fact, much of the knowledge about the performance of classic algorithms was developed decades ago, but that knowledge is still relevant to today's computers.

Cost model. We focus attention on properties of algorithms by articulating a *cost model* that defines the basic operations used by the algorithms we are studying to solve the problem at hand. For example, an appropriate cost model for the 3-sum problem, shown at right, is the number of times we access an array entry. With this cost model, we can make precise mathematical statements about properties of an algorithm, not just a particular implementation, as follows:

3-sum cost model. When studying algorithms to solve the 3-sum problem, we count *array accesses* (the number of times an array entry is accessed, for read or write).

Proposition B. The brute-force 3-sum algorithm uses $\sim N^3/2$ array accesses to compute the number of triples that sum to 0 among N numbers.

Proof: The algorithm accesses each of the 3 numbers for each of the $\sim N^3/6$ triples.

We use the term *proposition* to refer to mathematical truths about algorithms in terms of a cost model. Throughout this book, we study the algorithms that we consider within

the framework of a specific cost model. Our intent is to articulate cost models such that the order of growth of the running time for a given implementation is the same as the order of growth of the cost of the underlying algorithm (in other words, the cost model should include operations that fall within the inner loop). We seek precise mathematical results about algorithms (propositions) and also hypotheses about performance of implementations (properties) that you can check through experimentation. In this case, PROPOSITION B is a mathematical truth that supports the hypothesis stated in PROPERTY A, which we have validated with experiments, in accordance with the scientific method.

Summary. For many programs, developing a mathematical model of running time reduces to the following steps:

- Develop an *input model*, including a definition of the problem size.
- Identify the *inner loop*.
- Define a *cost model* that includes operations in the inner loop.
- Determine the frequency of execution of those operations for the given input. Doing so might require mathematical *analysis*—we will consider some examples in the context of specific fundamental algorithms later in the book.

If a program is defined in terms of multiple methods, we normally consider the methods separately. As an example, consider our example program of SECTION 1.1, `BinarySearch`.

Binary search. The *input model* is the array `a[]` of size N ; the *inner loop* is the statements in the single `while` loop; the *cost model* is the compare operation (compare the values of two array entries); and the *analysis*, discussed in SECTION 1.1 and given in full detail in PROPOSITION B in SECTION 3.1, shows that the number of compares is at most $\lg N + 1$.

Whitelist. The *input model* is the N numbers in the whitelist and the M numbers on standard input where we assume $M \gg N$; the *inner loop* is the statements in the single `while` loop; the *cost model* is the compare operation (inherited from binary search); and the *analysis* is immediate given the analysis of binary search—the number of compares is at most $M(\lg N + 1)$.

Thus, we draw the conclusion that the order of growth of the running time of the whitelist computation is at most $M \lg N$, subject to the following considerations:

- If N is small, the input-output cost might dominate.
- The number of compares depends on the input—it lies between $\sim M$ and $\sim M \lg N$, depending on how many of the numbers on standard input are in the whitelist and on how long the binary search takes to find the ones that are (typically it is $\sim M \lg N$).
- We are assuming that the cost of `Arrays.sort()` is small compared to $M \lg N$. `Arrays.sort()` implements the *mergesort* algorithm, and in SECTION 2.2, we will see that the order of growth of the running time of mergesort is $N \log N$ (see PROPOSITION G in CHAPTER 2), so this assumption is justified.

Thus, the model supports our hypothesis from SECTION 1.1 that the *binary search algorithm* makes the computation feasible when M and N are large. If we double the length of the standard input stream, then we can expect the running time to double; if we double the size of the whitelist, then we can expect the running time to increase only slightly.

DEVELOPING MATHEMATICAL MODELS for the analysis of algorithms is a fruitful area of research that is somewhat beyond the scope of this book. Still, as you will see with binary search, mergesort, and many other algorithms, understanding certain mathematical models is critical to understanding the efficiency of fundamental algorithms, so we often present details and/or quote the results of classic studies. When doing so, we encounter various functions and approximations that are widely used in mathematical analysis. For reference, we summarize some of this information in the tables below.

description	notation	definition
<i>floor</i>	$\lfloor x \rfloor$	largest integer not greater than x
<i>ceiling</i>	$\lceil x \rceil$	smallest integer not smaller than x
<i>natural logarithm</i>	$\ln N$	$\log_e N$ (x such that $e^x = N$)
<i>binary logarithm</i>	$\lg N$	$\log_2 N$ (x such that $2^x = N$)
<i>integer binary logarithm</i>	$\lfloor \lg N \rfloor$	largest integer not greater than $\lg N$ (# bits in binary representation of N) - 1
<i>harmonic numbers</i>	H_N	$1 + 1/2 + 1/3 + 1/4 + \dots + 1/N$
<i>factorial</i>	$N!$	$1 \times 2 \times 3 \times 4 \times \dots \times N$

Commonly encountered functions in the analysis of algorithms

description	approximation
<i>harmonic sum</i>	$H_N = 1 + 1/2 + 1/3 + 1/4 + \dots + 1/N \sim \ln N$
<i>triangular sum</i>	$1 + 2 + 3 + 4 + \dots + N \sim N^2/2$
<i>geometric sum</i>	$1 + 2 + 4 + 8 + \dots + N = 2N - 1 \sim 2N$ when $N = 2^n$
<i>Stirling's approximation</i>	$\lg N! = \lg 1 + \lg 2 + \lg 3 + \lg 4 + \dots + \lg N \sim N \lg N$
<i>binomial coefficients</i>	$\binom{N}{k} \sim N^k/k!$ when k is a small constant
<i>exponential</i>	$(1 - 1/x)^x \sim 1/e$

Useful approximations for the analysis of algorithms

Order-of-growth classifications We use just a few structural primitives (statements, conditionals, loops, nesting, and method calls) to implement algorithms, so very often the order of growth of the cost is one of just a few functions of the problem size N . These functions are summarized in the table on the facing page, along with the names that we use to refer to them, typical code that leads to each function, and examples.

Constant. A program whose running time's order of growth is *constant* executes a fixed number of operations to finish its job; consequently its running time does not depend on N . Most Java operations take constant time.

Logarithmic. A program whose running time's order of growth is *logarithmic* is barely slower than a constant-time program. The classic example of a program whose running time is logarithmic in the problem size is *binary search* (see `BinarySearch` on page 47). The base of the logarithm is not relevant with respect to the order of growth (since all logarithms with a constant base are related by a constant factor), so we use $\log N$ when referring to order of growth.

Linear. Programs that spend a constant amount of time processing each piece of input data, or that are based on a single `for` loop, are quite common. The order of growth of such a program is said to be *linear*—its running time is proportional to N .

Linearithmic. We use the term *linearithmic* to describe programs whose running time for a problem of size N has order of growth $N \log N$. Again, the base of the logarithm is not relevant with respect to the order of growth. The prototypical examples of linearithmic algorithms are `Merge.sort()` (see ALGORITHM 2.4) and `Quick.sort()` (see ALGORITHM 2.5).

Quadratic. A typical program whose running time has order of growth N^2 has two nested `for` loops, used for some calculation involving all pairs of N elements. The elementary sorting algorithms `Selection.sort()` (see ALGORITHM 2.1) and `Insertion.sort()` (see ALGORITHM 2.2) are prototypes of the programs in this classification.

Cubic. A typical program whose running time has order of growth N^3 has three nested `for` loops, used for some calculation involving all triples of N elements. Our example for this section, `ThreeSum`, is a prototype.

Exponential. In CHAPTER 6 (but not until then!) we will consider programs whose running times are proportional to 2^N or higher. Generally, we use the term *exponential* to refer to algorithms whose order of growth is b^N for any constant $b > 1$, even though different values of b lead to vastly different running times. Exponential algorithms are extremely slow—you will never run one of them to completion for a large problem. Still, exponential algorithms play a critical role in the theory of algorithms because

description	order of growth	typical code framework	description	example
<i>constant</i>	1	<code>a = b + c;</code>	<i>statement</i>	<i>add two numbers</i>
<i>logarithmic</i>	$\log N$	[see page 47]	<i>divide in half</i>	<i>binary search</i>
<i>linear</i>	N	<pre>double max = a[0]; for (int i = 1; i < N; i++) if (a[i] > max) max = a[i];</pre>	<i>loop</i>	<i>find the maximum</i>
<i>linearithmic</i>	$N \log N$	[see ALGORITHM 2.4]	<i>divide and conquer</i>	<i>mergesort</i>
<i>quadratic</i>	N^2	<pre>for (int i = 0; i < N; i++) for (int j = i+1; j < N; j++) if (a[i] + a[j] == 0) cnt++;</pre>	<i>double loop</i>	<i>check all pairs</i>
<i>cubic</i>	N^3	<pre>for (int i = 0; i < N; i++) for (int j = i+1; j < N; j++) for (int k = j+1; k < N; k++) if (a[i] + a[j] + a[k] == 0) cnt++;</pre>	<i>triple loop</i>	<i>check all triples</i>
<i>exponential</i>	2^N	[see CHAPTER 6]	<i>exhasutive search</i>	<i>check all subsets</i>

Summary of common order-of-growth hypotheses

there exists a large class of problems for which it seems that an exponential algorithm is the best possible choice.

THESE CLASSIFICATIONS ARE THE MOST COMMON, but certainly not a complete set. The order of growth of an algorithm's cost might be $N^2 \log N$ or $N^{3/2}$ or some similar function.

Indeed, the detailed analysis of algorithms can require the full gamut of mathematical tools that have been developed over the centuries.

A great many of the algorithms that we consider have straightforward performance characteristics that can be accurately described by one of the orders of growth that we have considered. Accordingly, we can usually work with specific propositions with a cost model, such as *mergesort uses between $\frac{1}{2}N \lg N$ and $N \lg N$ compares* that immediately imply hypotheses (properties) such as *the order of growth of mergesort's running time is linearithmic*. For economy, we abbreviate such a statement to just say *mergesort is linearithmic*.

The plots at left indicate the importance of the order of growth in practice. The x -axis is the problem size; the y -axis is the running time. These charts make plain that quadratic and cubic algorithms are not feasible for use on large problems. As it turns out, several important problems have natural solutions that are quadratic but clever algorithms that are linearithmic. Such algorithms (including mergesort) are critically important in practice because they enable us to address problem sizes far larger than could be addressed with quadratic solutions. Naturally, we therefore focus in this book on developing logarithmic, linear, and linearithmic algorithms for fundamental problems.

standard plot

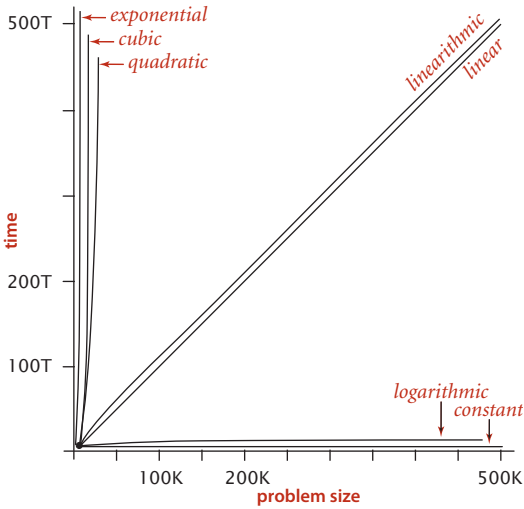

log-log plot

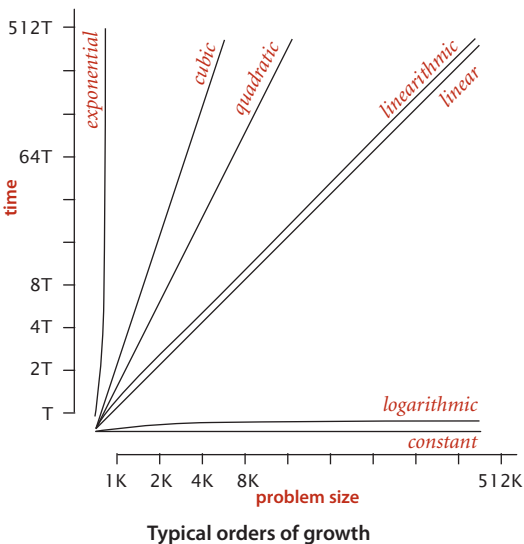

Designing faster algorithms One of the primary reasons to study the order of growth of a program is to help design a faster algorithm to solve the same problem. To illustrate this point, we consider next a faster algorithm for the 3-sum problem. How can we devise a faster algorithm, before even embarking on the study of algorithms? The answer to this question is that we *have* discussed and used two classic algorithms, *mergesort* and *binary search*, have introduced the facts that the mergesort is linearithmic and binary search is logarithmic. How can we take advantage of these algorithms to solve the 3-sum problem?

Warmup: 2-sum. Consider the easier problem of determining the number of *pairs* of integers in an input file that sum to 0. To simplify the discussion, assume also that the integers are distinct. This problem is easily solved in quadratic time by deleting the k loop and $a[k]$ from `ThreeSum.count()`, leaving a double loop that examines all pairs, as shown in the *quadratic* entry in the table on page 187 (we refer to such an implementation as `TwoSum`). The implementation below shows how mergesort and binary search (see page 47) can serve as a basis for a *linearithmic* solution to the 2-sum problem. The improved algorithm is based on the fact that an entry $a[i]$ is one of a pair that sums to 0 if and only if the value $-a[i]$ is in the array (and $a[i]$ is not zero). To solve the problem, we sort the array (to enable binary search) and then, for every entry $a[i]$ in the array, do a binary search for $-a[i]$ with `rank()` in `BinarySearch`. If the result is an index j with $j > i$, we increment the count.

This succinct test covers three cases:

- An unsuccessful binary search returns -1 , so we do not increment the count.
- If the binary search returns $j > i$, we have $a[i] + a[j] = 0$, so we increment the count.
- If the binary search returns j between 0 and i , we also have $a[i] + a[j] = 0$ but do not increment the count, to avoid double counting.

The result of the computation is precisely the same as the result of the quadratic algorithm, but it takes much less time. The running time of the mergesort is

```
import java.util.Arrays;

public class TwoSumFast
{
    public static int count(int[] a)
    { // Count pairs that sum to 0.
      Arrays.sort(a);
      int N = a.length;
      int cnt = 0;
      for (int i = 0; i < N; i++)
          if (BinarySearch.rank(-a[i], a) > i)
              cnt++;
      return cnt;
    }

    public static void main(String[] args)
    {
      int[] a = In.readInts(args[0]);
      StdOut.println(count(a));
    }
}
```

Linearithmic solution to the 2-sum problem

proportional to $N \log N$, and the N binary searches each take time proportional to $\log N$, so the running time of the whole algorithm is proportional to $N \log N$. Developing a faster algorithm like this is not merely an academic exercise—the faster algorithm enables us to address much larger problems. For example, you are likely to be able to solve the 2-sum problem for 1 million integers (`1Mints.txt`) in a reasonable amount of time on your computer, but you would have to wait quite a long time to do it with the quadratic algorithm (see EXERCISE 1.4.41).

Fast algorithm for 3-sum. The very same idea is effective for the 3-sum problem. Again, assume also that the integers are distinct. A pair $a[i]$ and $a[j]$ is part of a triple that sums to 0 if and only if the value $-(a[i] + a[j])$ is in the array (and not $a[i]$ or $a[j]$). The code below sorts the array, then does $N(N-1)/2$ binary searches that each take time proportional to $\log N$, for a total running time proportional to $N^2 \log N$. Note that in this case the cost of the sort is insignificant. Again, this solution enables us to address much larger problems (see EXERCISE 1.4.42). The plots in the figure at the bottom of the next page show the disparity in costs among these four algorithms for problem sizes in the range we have considered. Such differences certainly motivate the search for faster algorithms.

Lower bounds. The table on page 191 summarizes the discussion of this section. An interesting question immediately arises: Can we find algorithms for the 2-sum and 3-sum

problems that are substantially faster than `TwoSumFast` and `ThreeSumFast`? Is there a linear algorithm for 2-sum or a linearithmic algorithm for 3-sum? The answer to this question is *no* for 2-sum (under a model that counts and allows only comparisons of linear or quadratic functions of the numbers) and *no one knows* for 3-sum, though experts believe that the best possible algorithm for 3-sum is quadratic. The idea of a lower bound on the order of growth of the worst-case running time for all possible algorithms to solve a problem is a very powerful one, which we will

```
import java.util.Arrays;

public class ThreeSumFast
{
    public static int count(int[] a)
    { // Count triples that sum to 0.
        Arrays.sort(a);
        int N = a.length;
        int cnt = 0;
        for (int i = 0; i < N; i++)
            for (int j = i+1; j < N; j++)
                if (BinarySearch.rank(-a[i]-a[j], a) > j)
                    cnt++;
        return cnt;
    }

    public static void main(String[] args)
    {
        int[] a = In.readInts(args[0]);
        StdOut.println(count(a));
    }
}
```

$N^2 \lg N$ solution to the 3-sum problem

revisit in detail in SECTION 2.2 in the context of sorting. Non-trivial lower bounds are difficult to establish, but very helpful in guiding our search for efficient algorithms.

THE EXAMPLES IN THIS SECTION SET THE STAGE for our treatment of algorithms in this book. Throughout the book, our strategy for addressing new problems is the following:

- Implement and analyze a straightforward solution to the problem. We usually refer to such solutions, like `ThreeSum` and `TwoSum`, as the *brute-force* solution.
- Examine algorithmic improvements, usually designed to reduce the order of growth of the running time, such as `TwoSumFast` and `ThreeSumFast`.
- Run experiments to validate the hypotheses that the new algorithms are faster.

In many cases, we examine *several* algorithms for the same problem, because running time is only one consideration when choosing an algorithm for a practical problem. We will develop this idea in detail in the context of fundamental problems throughout the book.

algorithm	order of growth of running time
<code>TwoSum</code>	N^2
<code>TwoSumFast</code>	$N \log N$
<code>ThreeSum</code>	N^3
<code>ThreeSumFast</code>	$N^2 \log N$

Summary of running times

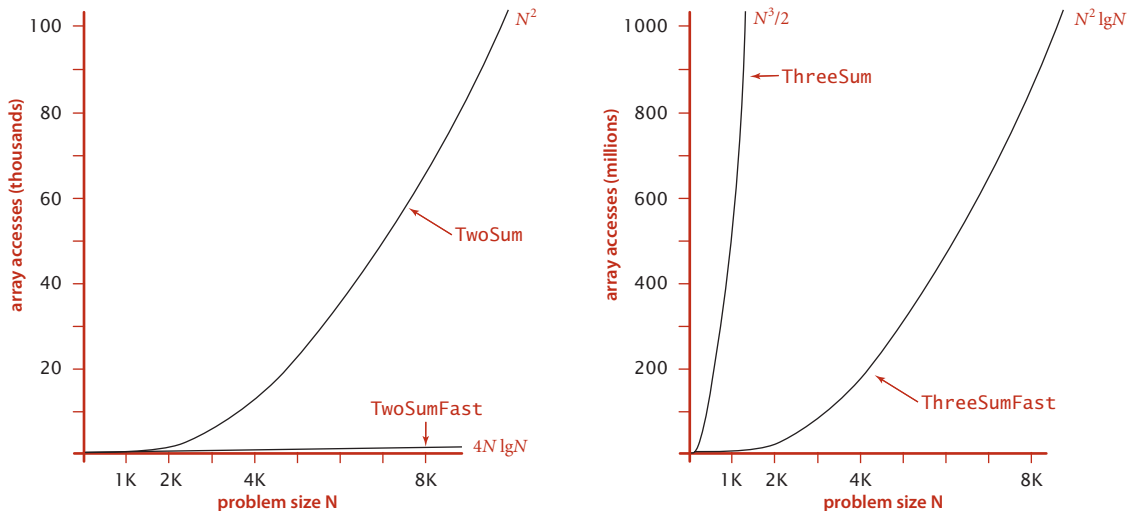

Costs of algorithms to solve the 2-sum and 3-sum problems

Doubling ratio experiments The following is a simple and effective shortcut for predicting performance and for determining the approximate order of growth of the running time of any program:

- Develop an input generator that produces inputs that model the inputs expected in practice (such as the random integers in `timeTrial()` in `DoublingTest`).
- Run the program `DoublingRatio` given below, a modification of `DoublingTest` that calculates the ratio of each running time with the previous.
- Run until the ratios approach a limit 2^b .

This test is not effective if the ratios do not approach a limiting value, but they do for many, many programs, implying the following conclusions:

- The order of growth of the running time is approximately N^b .
- To predict running times, multiply the last observed running time by 2^b and double N , continuing as long as desired. If you want to predict for an input size that is not a power of 2 times N , you can adjust ratios accordingly (see EXERCISE 1.4.9).

As illustrated below, the ratio for `ThreeSum` is about 8 and we can predict the running times for $N = 16,000, 32,000, 64,000$ to be 408.8, 3270.4, 26163.2 seconds, respectively, just by successively multiplying the last time for 8,000 (51.1) by 8.

program to perform experiments

```
public class DoublingRatio
{
    public static double timeTrial(int N)
    // same as for DoublingTest (page 177)
    public static void main(String[] args)
    {
        double prev = timeTrial(125);
        for (int N = 250; true; N += N)
        {
            double time = timeTrial(N);
            StdOut.printf("%6d %7.1f ", N, time);
            StdOut.printf("%5.1f\n", time/prev);
            prev = time;
        }
    }
}
```

results of experiments

```
% java DoublingRatio
250      0.0    2.7
500      0.0    4.8
1000     0.1    6.9
2000     0.8    7.7
4000     6.4    8.0
8000     51.1   8.0
```

predictions

```
16000    408.8   8.0
32000    3270.4  8.0
64000    26163.2 8.0
```

This test is roughly equivalent to the process described on page 176 (run experiments, plot values on a log-log plot to develop the hypothesis that the running time is aN^b , determine the value of b from the slope of the line, then solve for a), but it is simpler to apply. Indeed, you can accurately predict performance by hand when you run `DoublingRatio`. As the ratio approaches a limit, just multiply by that ratio to fill in later values in the table. Your approximate model of the order of growth is a power law with the binary logarithm of that ratio as the power.

Why does the ratio approach a constant? A simple mathematical calculation shows that to be the case for all of the common orders of growth just discussed (except exponential):

Proposition C. (Doubling ratio) If $T(N) \sim aN^b \lg N$ then $T(2N)/T(N) \sim 2^b$.

Proof: Immediate from the following calculation:

$$\begin{aligned} T(2N)/T(N) &= a(2N)^b \lg(2N) / aN^b \lg N \\ &= 2^b (1 + \lg 2 / \lg N) \\ &\sim 2^b \end{aligned}$$

Generally, the logarithmic factor cannot be ignored when developing a mathematical model, but it plays a less important role in predicting performance with a doubling hypothesis.

YOU SHOULD CONSIDER running doubling ratio experiments for every program that you write where performance matters—doing so is a very simple way to estimate the order of growth of the running time, perhaps revealing a performance bug where a program may turn out to be not as efficient as you might think. More generally, we can use hypotheses about the order of growth of the running time of programs to predict performance in one of the following ways:

Estimating the feasibility of solving large problems. You need to be able to answer this basic question for every program that you write: *Will the program be able to process this given input data in a reasonable amount of time?* To address such questions for a large amount of data, we extrapolate by a much larger factor than for doubling, say 10, as shown in the fourth column in the table at the bottom of the next page. Whether it is an investment banker running daily financial models or a scientist running a program to analyze experimental data or an engineer running simulations to test a design, it is not unusual for people to regularly run programs that take several hours to complete,

so the table focuses on that situation. Knowing the order of growth of the running time of an algorithm provides precisely the information that you need to understand limitations on the size of the problems that you can solve. *Developing such understanding is the most important reason to study performance.* Without it, you are likely have no idea how much time a program will consume; with it, you can make a back-of-the-envelope calculation to estimate costs and proceed accordingly.

Estimating the value of using a faster computer. You also may be faced with this basic question, periodically: *How much faster can I solve the problem if I get a faster computer?* Generally, if the new computer is x times faster than the old one, you can improve your running time by a factor of x . But it is usually the case that you can address larger problems with your new computer. How will that change affect the running time? Again, the order of growth is precisely the information needed to answer that question.

A FAMOUS RULE OF THUMB known as *Moore's Law* implies that you can expect to have a computer with about double the speed and double the memory 18 months from now, or a computer with about 10 times the speed and 10 times the memory in about 5 years. The table below demonstrates that you cannot keep pace with Moore's Law if you are using a quadratic or a cubic algorithm, and you can quickly determine whether that is the case by doing a doubling ratio test and checking that the ratio of running times as the input size doubles approaches 2, not 4 or 8.

order of growth of time		for a program that takes a few hours for input of size N			
description	function	2x factor	10x factor	predicted time for $10N$	predicted time for $10N$ on a 10x faster computer
<i>linear</i>	N	2	10	a day	a few hours
<i>linearithmic</i>	$N \log N$	2	10	a day	a few hours
<i>quadratic</i>	N^2	4	100	a few weeks	a day
<i>cubic</i>	N^3	8	1,000	several months	a few weeks
<i>exponential</i>	2^N	2^N	2^{9N}	never	never

Predictions on the basis of order-of-growth function

Caveats There are many reasons that you might get inconsistent or misleading results when trying to analyze program performance in detail. All of them have to do with the idea that one or more of the basic assumptions underlying our hypotheses might be not quite correct. We can develop new hypotheses based on new assumptions, but the more details that we need to take into account, the more care is required in the analysis.

Large constants. With leading-term approximations, we ignore constant coefficients in lower-order terms, which may not be justified. For example, when we approximate the function $2N^2 + cN$ by $\sim 2N^2$, we are assuming that c is small. If that is not the case (suppose that c is 10^3 or 10^6) the approximation is misleading. Thus, we have to be sensitive to the possibility of large constants.

Nondominant inner loop. The assumption that the inner loop dominates may not always be correct. The cost model might miss the true inner loop, or the problem size N might not be sufficiently large to make the leading term in the mathematical description of the frequency of execution of instructions in the inner loop so much larger than lower-order terms that we can ignore them. Some programs have a significant amount of code outside the inner loop that needs to be taken into consideration. In other words, the cost model may need to be refined.

Instruction time. The assumption that each instruction always takes the same amount of time is not always correct. For example, most modern computer systems use a technique known as *caching* to organize memory, in which case accessing elements in huge arrays can take much longer if they are not close together in the array. You might observe the effect of caching for `ThreeSum` by letting `DoublingTest` run for a while. After seeming to converge to 8, the ratio of running times may jump to a larger value for large arrays because of caching.

System considerations. Typically, there are many, many things going on in your computer. Java is one application of many competing for resources, and Java itself has many options and controls that significantly affect performance. A garbage collector or a just-in-time compiler or a download from the internet might drastically affect the results of experiments. Such considerations can interfere with the bedrock principle of the scientific method that experiments should be reproducible, since what is happening at this moment in your computer will never be reproduced again. Whatever else is going on in your system should *in principle* be negligible or possible to control.

Too close to call. Often, when we compare two different programs for the same task, one might be faster in some situations, and slower in others. One or more of the considerations just mentioned could make the difference. There is a natural tendency among

some programmers (and some students) to devote an extreme amount of energy running races to find the “best” implementation, but such work is best left for experts.

Strong dependence on inputs. One of the first assumptions that we made in order to determine the order of growth of the program’s running time of a program was that the running time should be relatively insensitive to the inputs. When that is not the case, we may get inconsistent results or be unable to validate our hypotheses. For example, suppose that we modify `ThreeSum` to answer the question *Does the input have a triple that sums to 0?* by changing it to return a boolean value, replacing `cnt++` by `return true` and adding `return false` as the last statement. The order of growth of the running time of this program is *constant* if the first three integers sum to 0 and *cubic* if there are no such triples in the input.

Multiple problem parameters. We have been focusing on measuring performance as a function of a *single* parameter, generally the value of a command-line argument or the size of the input. However, it is not unusual to have several parameters. A typical example arises when an algorithm involves building a data structure and then performing a sequence of operations that use that data structure. Both the size of the data structure and the number of operations are parameters for such applications. We have already seen an example of this in our analysis of the problem of whitelisting using binary search, where we have N numbers in the whitelist and M numbers on standard input and a typical running time proportional to $M \log N$.

Despite all these caveats, understanding the order of growth of the running time of each program is valuable knowledge for any programmer, and the methods that we have described are powerful and broadly applicable. Knuth’s insight was that we can carry these methods through to the last detail *in principle* to make detailed, accurate predictions. Typical computer systems are extremely complex and close analysis is best left for experts, but the same methods are effective for developing approximate estimates of the running time of any program. A rocket scientist needs to have some idea of whether a test flight will land in the ocean or in a city; a medical researcher needs to know whether a drug trial will kill or cure all the subjects; and any scientist or engineer using a computer program needs to have some idea of whether it will run for a second or for a year.

Coping with dependence on inputs For many problems, one of the most significant of the caveats just mentioned is the dependence on inputs, because running times can vary widely. The running time of the modification of `ThreeSum` mentioned on the facing page ranges from constant to cubic, depending on the input, so a closer analysis is required if we want to predict performance. We briefly consider here some of the approaches that are effective and that we will consider for specific algorithms later in the book.

Input models. One approach is to more carefully model the kind of input to be processed in the problems that we need to solve. For example, we might assume that the numbers in the input to `ThreeSum` are random `int` values. This approach is challenging for two reasons:

- The model may be unrealistic.
- The analysis may be extremely difficult, requiring mathematical skills quite beyond those of the typical student or programmer.

The first of these is the more significant, often because the goal of a computation is to *discover* characteristics of the input. For example, if we are writing a program to process a genome, how can we estimate its performance on a different genome? A good model describing the genomes found in nature is precisely what scientists seek, so estimating the running time of our programs on data found in nature actually amounts to contributing to that model! The second challenge leads to a focus on mathematical results only for our most important algorithms. We will see several examples where a simple and tractable input model, in conjunction with classical mathematical analysis, helps us predict performance.

Worst-case performance guarantees. Some applications demand that the running time of a program be less than a certain bound, no matter what the input. To provide such performance *guarantees*, theoreticians take an extremely pessimistic view of the performance of algorithms: what would the running time be in the *worst case*? For example, such a conservative approach might be appropriate for the software that runs a nuclear reactor or a pacemaker or the brakes in your car. We want to guarantee that such software completes its job within the bounds that we set because the result could be catastrophic if it does not. Scientists normally do not contemplate the worst case when studying the natural world: in biology, the worst case might be the extinction of the human race; in physics, the worst case might be the end of the universe. But the worst case can be a very real concern in computer systems, where the input may be generated by another (potentially malicious) user, rather than by nature. For example, websites that do not use algorithms with performance guarantees are subject to *denial-of-service* attacks, where hackers flood them with pathological requests that make them

run much more slowly than planned. Accordingly, many of our algorithms are designed to provide performance guarantees, such as the following:

Proposition D. In the linked-list implementations of `Bag` (ALGORITHM 1.4), `Stack` (ALGORITHM 1.2), and `Queue` (ALGORITHM 1.3), all operations take constant time in the worst case.

Proof: Immediate from the code. The number of instructions executed for each operation is bounded by a small constant. *Caveat:* This argument depends upon the (reasonable) assumption that the Java system creates a new `Node` in constant time.

Randomized algorithms. One important way to provide a performance guarantee is to introduce randomness. For example, the quicksort algorithm for sorting that we study in SECTION 2.3 (perhaps the most widely used sorting algorithm) is quadratic in the worst case, but randomly ordering the input gives a probabilistic guarantee that its running time is linearithmic. Every time you run the algorithm, it will take a different amount of time, but the chance that the time will not be linearithmic is so small as to be negligible. Similarly, the hashing algorithms for symbol tables that we study in SECTION 3.4 (again, perhaps the most widely used approach) are linear-time in the worst case, but constant-time under a probabilistic guarantee. These guarantees are not absolute, but the chance that they are invalid is less than the chance your computer will be struck by lightning. Thus, such guarantees are as useful in practice as worst-case guarantees.

Sequences of operations. For many applications, the algorithm “input” might be not just data, but the sequence of operations performed by the client. For example, a pushdown stack where the client pushes N values, then pops them all, may have quite different performance characteristics from one where the client issues an alternating sequence N of push and pop operations. Our analysis has to take both situations into account (or to include a reasonable model of the sequence of operations).

Amortized analysis. Accordingly, another way to provide a performance guarantee is to *amortize* the cost, by keeping track of the total cost of all operations, divided by the number of operations. In this setting, we can allow some expensive operations, while keeping the average cost of operations low. The prototypical example of this type of analysis is the study of the resizing array data structure for `Stack` that we considered in SECTION 1.3 (ALGORITHM 1.1 on page 141). For simplicity, suppose that N is a power of 2. Starting with an empty structure, how many array entries are accessed for N consecutive calls to `push()`? This quantity is easy to calculate: the number of array accesses is

$$N + 4 + 8 + 16 + \dots + 2N = 5N - 4$$

The first term accounts for the array access within each of the N calls to `push()`; the subsequent terms account for the array accesses to initialize the data structure each time it doubles in size. Thus the *average number of array accesses per operation* is constant, even though the last operation takes linear time. This is known as an “amortized” analysis because we spread the cost of the few expensive operations, by assigning a portion of it to each of a large number of inexpensive operations. VisualAccumulator provides an easy way to illustrate the process, shown above.

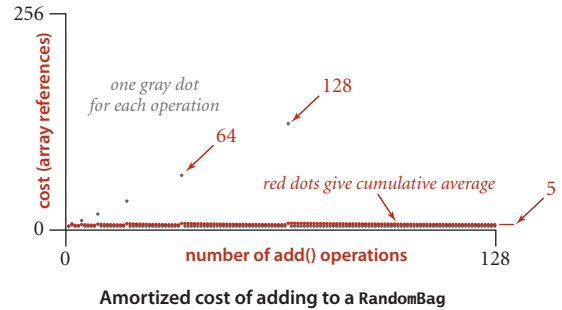

Proposition E. In the resizing array implementation of Stack (ALGORITHM 1.1), the average number of array accesses for any sequence of operations starting from an empty data structure is constant in the worst case.

Proof sketch: For each `push()` that causes the array to grow (say from size N to size $2N$), consider the $N/2 - 1$ `push()` operations that most recently caused the stack size to grow to k , for k from $N/2 + 2$ to N . Averaging the $4N$ array accesses to grow the array with $N/2$ array accesses (one for each push), we get an average cost of 9 array accesses per operation. Proving that the number of array accesses used by any sequence of M operations is proportional to M is more intricate (see EXERCISE 1.4.32)

This kind of analysis is widely applicable. In particular, we use resizing arrays as the underlying data structure for several algorithms that we consider later in this book.

IT IS THE TASK OF THE ALGORITHM ANALYST to discover as much relevant information about an algorithm as possible, and it is the task of the applications programmer to apply that knowledge to develop programs that effectively solve the problems at hand. Ideally, we want algorithms that lead to clear and compact code that provides both a good guarantee and good performance on input values of interest. Many of the classic algorithms that we consider in this chapter are important for a broad variety of applications precisely because they have these properties. Using them as models, you can develop good solutions yourself for typical problems that you face while programming.

Memory As with running time, a program's memory usage connects directly to the physical world: a substantial amount of your computer's circuitry enables your program to store values and later retrieve them. The more values you need to have stored at any given instant, the more circuitry you need. You probably are aware of limits on memory usage on your computer (even more so than for time) because you probably have paid extra money to get more memory.

Memory usage is well-defined for Java on your computer (every value requires precisely the same amount of memory each time that you run your program), but Java is implemented on a very wide range of computational devices, and memory consumption is implementation-dependent. For economy, we use the word *typical* to signal that values are subject to machine dependencies.

type	bytes
boolean	1
byte	1
char	2
int	4
float	4
long	8
double	8

Typical memory requirements for primitive types

One of Java's most significant features is its memory allocation system, which is supposed to relieve you from having to worry about memory. Certainly, you are well-advised to take advantage of this feature when appropriate. Still, it is your responsibility to know, at least approximately, when a program's memory requirements will prevent you from solving a given problem.

Analyzing memory usage is much easier than analyzing running time, primarily because not as many program statements are involved (just declarations) and because the analysis reduces complex objects to the primitive types, whose memory usage is well-defined and simple to understand: we can count up the number of variables and weight them by the number of bytes according to their type. For example, since the Java `int` data type is the set of integer values between $-2,147,483,648$ and $2,147,483,647$, a grand total of 2^{32} different values, typical Java implementations use 32 bits to represent `int` values. Similar considerations hold for other primitive types: typical Java implementations use 8-bit bytes, representing each `char` value with 2 bytes (16 bits), each `int` value with 4 bytes (32 bits), each `double` and each `long` value with 8 bytes (64 bits), and each `boolean` value with 1 byte (since computers typically access memory one byte at a time). Combined with knowledge of the amount of memory available, you can calculate limitations from these values. For example, if you have 1GB of memory on your computer (1 billion bytes), you cannot fit more than about 32 million `int` values or 16 million `double` values in memory at any one time.

On the other hand, analyzing memory usage is subject to various differences in machine hardware and in Java implementations, so you should consider the specific examples that we give as indicative of how you might go about determining memory usage when warranted, not the final word for your computer. For example, many data structures involve representation of machine addresses, and the amount of memory

needed for a machine address varies from machine to machine. For consistency, we assume that 8 bytes are needed to represent addresses, as is typical for 64-bit architectures that are now widely used, recognizing that many older machines use a 32-bit architecture that would involve just 4 bytes per machine address.

Objects. To determine the memory usage of an object, we add the amount of memory used by each instance variable to the overhead associated with each object, typically 16 bytes. The overhead includes a reference to the object's class, garbage collection information, and synchronization information. Moreover, the memory usage is typically padded to be a multiple of 8 bytes (machine words, on a 64-bit machine). For example, an Integer object uses 24 bytes (16 bytes of overhead, 4 bytes for its `int` instance variable, and 4 bytes of padding). Similarly, a Date (page 91) object also uses 32 bytes: 16 bytes of overhead, 4 bytes for each of its three `int` instance variables, and 4 bytes of padding. A reference to an object typically is a memory address and thus uses 8 bytes of memory. For example, a Counter (page 89) object uses 32 bytes: 16 bytes of overhead, 8 bytes for its `String` instance variable (a reference), 4 bytes for its `int` instance variable, and 4 bytes of padding. When we account for the memory for a reference, we account separately for the memory for the object itself, so this total does not count the memory for the `String` value.

Linked lists. A nested non-static (inner) class such as our Node class (page 142) requires an extra 8 bytes of overhead (for a reference to the enclosing instance). Thus, a Node object uses 40 bytes (16 bytes of object overhead, 8 bytes each for the references to the `Item` and `Node` objects, and 8 bytes for the extra overhead). Thus, since an Integer object uses 24 bytes, a stack with N integers built with a linked-list representation (ALGORITHM 1.2) uses $32 + 64N$ bytes, the usual 16 for object overhead for `Stack`, 8 for its reference instance variable, 4 for its `int` instance variable, 4 for padding, and 64 for each entry, 40 for a `Node` and 24 for an `Integer`.

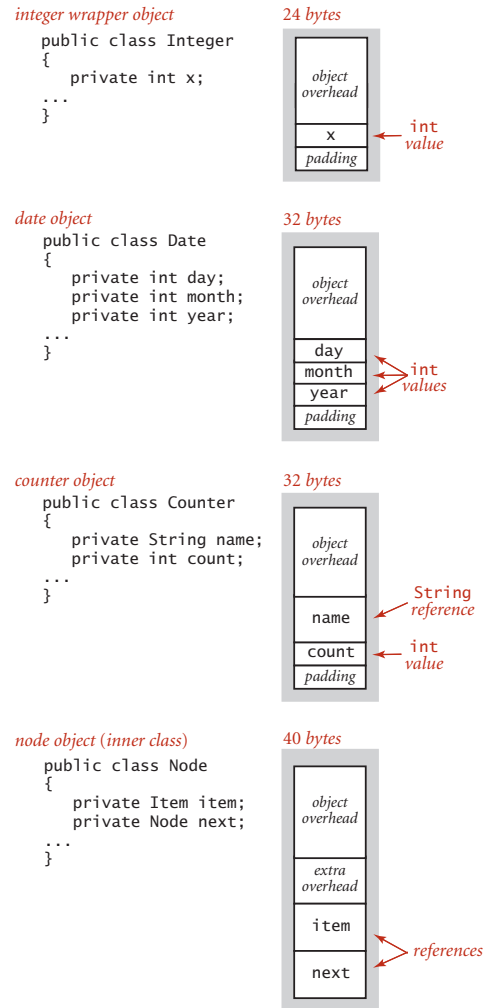

Typical object memory requirements

Arrays. Typical memory requirements for various types of arrays in Java are summarized in the diagrams on the facing page. Arrays in Java are implemented as objects, typically with extra overhead for the length. An *array of primitive-type values* typically requires 24 bytes of header information (16 bytes of object overhead, 4 bytes for the length, and 4 bytes of padding) plus the memory needed to store the values. For example, an array of N `int` values uses $24 + 4N$ bytes (rounded up to be a multiple of 8), and an array of N `double` values uses $24 + 8N$ bytes. An *array of objects* is an array of references to the objects, so we need to add the space for the references to the space required for the objects. For example, an array of N `Date` objects (page 91) uses 24 bytes (array overhead) plus $8N$ bytes (references) plus 32 bytes for each object and 4 bytes of padding, for a grand total of $24 + 40N$ bytes. A *two-dimensional array* is an array of arrays (each array is an object). For example, a two-dimensional M -by- N array of `double` values uses 24 bytes (overhead for the array of arrays) plus $8M$ bytes (references to the row arrays) plus M times 16 bytes (overhead from the row arrays) plus M times N times 8 bytes (for the N `double` values in each of the M rows) for a grand total of $8NM + 32M + 24 \sim 8NM$ bytes. When array entries are objects, a similar accounting leads to a total of $8NM + 32M + 24 \sim 8NM$ bytes for the array of arrays filled with references to objects, plus the memory for the objects themselves.

String objects. We account for memory in Java's `String` objects in the same way as for any other object, except that aliasing is common for strings. The standard `String` implementation has four instance variables: a reference to a character array (8 bytes) and three `int` values (4 bytes each). The first `int` value is an offset into the character array; the second is a count (the string length). In terms of the instance variable names in the drawing on the facing page, the string that is represented consists of the characters `value[offset]` through `value[offset + count - 1]`. The third `int` value in `String` objects is a hash code that saves recomputation in certain circumstances that need not concern us now. Therefore, each `String` object uses a total of 40 bytes (16 bytes for object overhead plus 4 bytes for each of the three `int` instance variables plus 8 bytes for the array reference plus 4 bytes of padding). This space requirement is in addition to the space needed for the characters themselves, which are in the array. The space needed for the characters is accounted for separately because the `char` array is often shared among strings. Since `String` objects are immutable, this arrangement allows the implementation to save memory when `String` objects have the same underlying `value[]`.

String values and substrings. A `String` of length N typically uses 40 bytes (for the `String` object) plus $24 + 2N$ bytes (for the array that contains the characters) for a total of $64 + 2N$ bytes. But it is typical in string processing to work with substrings, and Java's representation is meant to allow us to do so without having to make copies of

array of int values

```
int[] a = new int[N];
```

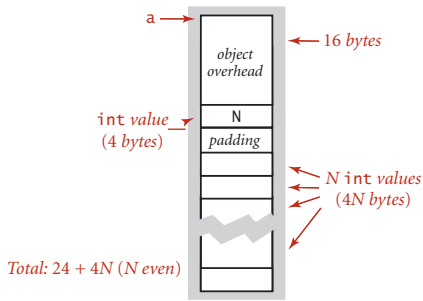

array of double values

```
double[] c = new double[N];
```

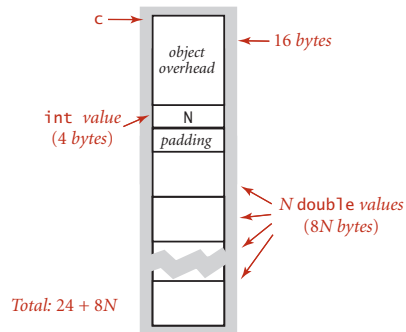

array of objects

```
Date[] d;
d = new Date[N];
for (int k = 0; k < N; k++)
{
    ...
    a[k] = new Date (...);
}
```

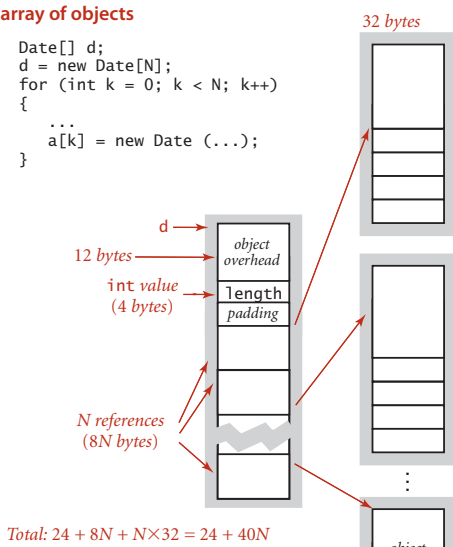

summary

type	bytes
<code>int[]</code>	$\sim 4N$
<code>double[]</code>	$\sim 8N$
<code>Date[]</code>	$\sim 40N$
<code>double[][]</code>	$\sim 8NM$

array of arrays (two-dimensional array)

```
double[][] t;
t = new double[M][N];
```

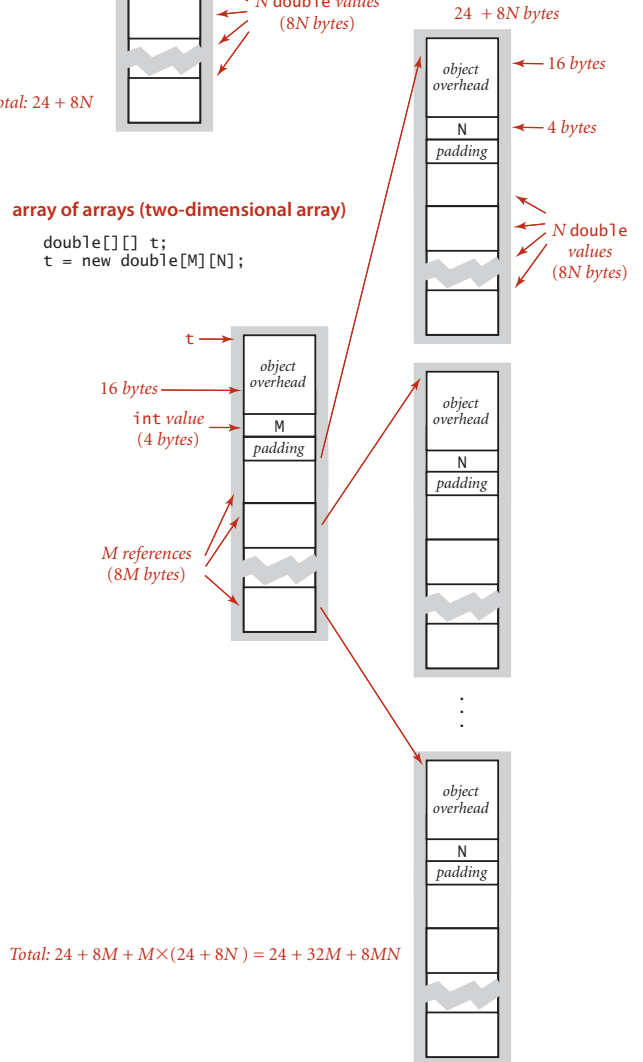

Typical memory requirements for arrays of `int` values, `double` values, objects, and arrays

String object (Java library)

```
public class String
{
    private char[] value;
    private int offset;
    private int count;
    private int hash;
    ...
}
```

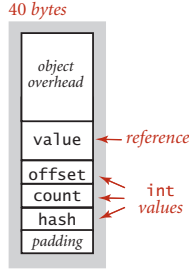

substring example

```
String genome = "CGCCTGGCGTCTGTAC";
String codon = genome.substring(6, 3);
```

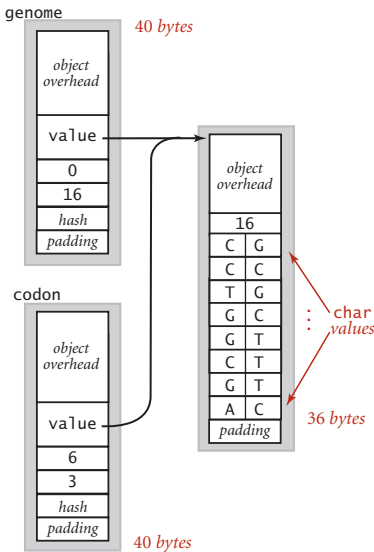

A String and a substring

the string's characters. When you use the `substring()` method, you create a new `String` object (40 bytes) but reuse the same `value[]` array, so a substring of an existing string takes just 40 bytes. The character array containing the original string is aliased in the object for the substring; the offset and length fields identify the substring. In other words, *a substring takes constant extra memory and forming a substring takes constant time*, even when the lengths of the string and the substring are huge. A naive representation that requires copying characters to make substrings would take linear time and space. The ability to create a substring using space (and time) independent of its length is the key to efficiency in many basic string-processing algorithms.

THESE BASIC MECHANISMS ARE EFFECTIVE for estimating the memory usage of a great many programs, but there are numerous complicating factors that can make the task significantly more difficult. We have already noted the potential effect of aliasing. Moreover, memory consumption is a complicated dynamic process when function calls are involved because the system memory allocation mechanism plays a more important role, with more system dependencies. For example, when your program calls a method, the system allocates the memory needed for the method (for its local variables) from a special area of memory called the *stack* (a system pushdown stack), and when the method returns to the caller, the memory is returned

to the stack. For this reason, creating arrays or other large objects in recursive programs is dangerous, since each recursive call implies significant memory usage. When you create an object with `new`, the system allocates the memory needed for the object from another special area of memory known as the *heap* (not the same as the binary heap data structure we consider in SECTION 2.4), and you must remember that every object lives until no references to it remain, at which point a system process known as *garbage collection* reclaims its memory for the heap. Such dynamics can make the task of precisely estimating memory usage of a program challenging.

Perspective Good performance is important. An impossibly slow program is almost as useless as an incorrect one, so it is certainly worthwhile to pay attention to the cost at the outset, to have some idea of which kinds of problems you might feasibly address. In particular, it is always wise to have some idea of which code constitutes the inner loop of your programs.

Perhaps the most common mistake made in programming is to pay too much attention to performance characteristics. Your first priority is to make your code clear and correct. Modifying a program for the sole purpose of speeding it up is best left for experts. Indeed, doing so is often counterproductive, as it tends to create code that is complicated and difficult to understand. C. A. R. Hoare (the inventor of quicksort and a leading proponent of writing clear and correct code) once summarized this idea by saying that “*premature optimization is the root of all evil,*” to which Knuth added the qualifier “*(or at least most of it) in programming.*” Beyond that, improving the running time is not worthwhile if the available cost benefits are insignificant. For example, improving the running time of a program by a factor of 10 is inconsequential if the running time is only an instant. Even when a program takes a few minutes to run, the total time required to implement and debug an improved algorithm might be substantially more than the time required simply to run a slightly slower one—you may as well let the computer do the work. Worse, you might spend a considerable amount of time and effort implementing ideas that should in theory improve a program but do not do so in practice.

Perhaps the second most common mistake made in programming is to ignore performance characteristics. Faster algorithms are often more complicated than brute-force ones, so you might be tempted to accept a slower algorithm to avoid having to deal with more complicated code. However, you can sometimes reap huge savings with just a few lines of good code. Users of a surprising number of computer systems lose substantial time unknowingly waiting for brute-force quadratic algorithms to finish solving a problem, when linear or linearithmic algorithms are available that could solve the problem in a fraction of the time. When we are dealing with huge problem sizes, we often have no choice but to seek better algorithms.

We generally take as implicit the methodology described in this section to estimate memory usage and to develop an order-of-growth hypothesis of the running time from a tilde approximation resulting from a mathematical analysis within a cost model, and to check those hypotheses with experiments. Improving a program to make it more clear, efficient, and elegant should be your goal every time that you work on it. If you pay attention to the cost all the way through the development of a program, you will reap the benefits every time you use it.

Q&A

Q. Why not use `StdRandom` to generate random values instead of maintaining the file `1Mints.txt`?

A. It is easier to debug code in development and to reproduce experiments. `StdRandom` produces different values each time it is called, so running a program after fixing a bug may not test the fix! You could use the `initialize()` method in `StdRandom` to address this problem, but a reference file such as `1Mints.txt` makes it easier to add test cases while debugging. Also, different programmers can compare performance on different computers, without worrying about the input model. Once you have debugged a program and have a good idea of how it performs, it is certainly worthwhile to test it on random data. For example, `DoublingTest` and `DoublingRatio` take this approach.

Q. I ran `DoublingRatio` on my computer, but the results were not as consistent as in the book. Some of the ratios were not close to 8. Why?

A. That is why we discussed “caveats” on page 195. Most likely, your computer’s operating system decided to do something else during the experiment. One way to mitigate such problems is to invest more time in more experiments. For example, you could change `DoublingTest` to run the experiments 1,000 times for each N , giving a much more accurate estimate for the running time for each size (see EXERCISE 1.4.39).

Q. What, exactly, does “as N grows” mean in the definition of the tilde notation?

A. The formal definition of $f(N) \sim g(N)$ is $\lim_{N \rightarrow \infty} f(N)/g(N) = 1$.

Q. I’ve seen other notations for describing order of growth. What’s the story?

A. The “big-Oh” notation is widely used: we say that $f(N)$ is $O(g(N))$ if there exist constants c and N_0 such that $|f(N)| < c g(N)$ for all $N > N_0$. This notation is very useful in providing asymptotic upper bounds on the performance of algorithms, which is important in the theory of algorithms. But it is not useful for predicting performance or for comparing algorithms.

Q. Why not?

A. The primary reason is that it describes only an *upper bound* on the running time. Actual performance might be much better. The running time of an algorithm might be both $O(N^2)$ and $\sim a N \log N$. As a result, it cannot be used to justify tests like our doubling ratio test (see PROPOSITION C on page 193).

Q. So why is the big-Oh notation so widely used?

A. It facilitates development of bounds on the order of growth, even for complicated algorithms for which more precise analysis might not be feasible. Moreover, it is compatible with the “big-Omega” and “big-Theta” notations that theoretical computer scientists use to classify algorithms by bounding their worst-case performance. We say that $f(N)$ is $\Omega(g(N))$ if there exist constants c and N_0 such that $|f(N)| > c g(N)$ for $N > N_0$; and if $f(N)$ is $O(g(N))$ and $\Omega(g(N))$, we say that $f(N)$ is $\Theta(g(N))$. The “big-Omega” notation is typically used to describe a *lower bound* on the worst case, and the “big-Theta” notation is typically used to describe the performance of algorithms that are *optimal* in the sense that no algorithm can have better asymptotic worst-case order of growth. Optimal algorithms are certainly worth considering in practical applications, but there are many other considerations, as you will see.

Q. Aren't upper bounds on asymptotic performance important?

A. Yes, but we prefer to discuss precise results in terms of frequency of statement execution with respect to cost models, because they provide more information about algorithm performance and because deriving such results is feasible for the algorithms that we discuss. For example, we say “ThreeSum uses $\sim N^3/2$ array accesses” and “the number of times `cnt++` is executed in ThreeSum is $\sim N^3/6$ in the worst case,” which is a bit more verbose but much more informative than the statement “the running time of ThreeSum is $O(N^3)$.”

Q. When the order of growth of the running time of an algorithm is $N \log N$, the doubling test will lead to the hypothesis that the running time is $\sim aN$ for a constant a . Isn't that a problem?

A. We have to be careful not to try to infer that the experimental data implies a particular mathematical model, but when we are just predicting performance, this is not really a problem. For example, when N is between 16,000 and 32,000, the plots of $14N$ and $N \lg N$ are very close to one another. The data fits both curves. As N increases, the curves become closer together. It actually requires some care to experimentally check the hypothesis that an algorithm's running time is linearithmic but not linear.

Q. Does `int[] a = new int[N]` count as N array accesses (to initialize entries to 0)?

A. Most likely yes, so we make that assumption in this book, though a sophisticated compiler implementation might try to avoid this cost for huge sparse arrays.

EXERCISES

1.4.1 Show that the number of different triples that can be chosen from N items is precisely $N(N-1)(N-2)/6$. *Hint*: Use mathematical induction.

1.4.2 Modify `ThreeSum` to work properly even when the `int` values are so large that adding two of them might cause overflow.

1.4.3 Modify `DoublingTest` to use `StdDraw` to produce plots like the standard and log-log plots in the text, rescaling as necessary so that the plot always fills a substantial portion of the window.

1.4.4 Develop a table like the one on page 181 for `TwoSum`.

1.4.5 Give tilde approximations for the following quantities:

a. $N + 1$

b. $1 + 1/N$

c. $(1 + 1/N)(1 + 2/N)$

d. $2N^3 - 15N^2 + N$

e. $\lg(2N)/\lg N$

f. $\lg(N^2 + 1) / \lg N$

g. $N^{100} / 2^N$

1.4.6 Give the order of growth (as a function of N) of the running times of each of the following code fragments:

```
a. int sum = 0;
   for (int n = N; n > 0; n /= 2)
       for(int i = 0; i < n; i++)
           sum++;
```

```
b. int sum = 0;
   for (int i = 1; i < N; i *= 2)
       for (int j = 0; j < i; j++)
           sum++;
```

```
c.  int sum = 0;
    for (int i = 1; i < N; i *= 2)
        for (int j = 0; j < N; j++)
            sum++;
```

1.4.7 Analyze ThreeSum under a cost model that counts arithmetic operations (and comparisons) involving the input numbers.

1.4.8 Write a program to determine the number pairs of values in an input file that are equal. If your first try is quadratic, think again and use `Arrays.sort()` to develop a linearithmic solution.

1.4.9 Give a formula to predict the running time of a program for a problem of size N when doubling experiments have shown that the doubling factor is 2^b and the running time for problems of size N_0 is T .

1.4.10 Modify binary search so that it always returns the element with the smallest index that matches the search element (and still guarantees logarithmic running time).

1.4.11 Add an instance method `howMany()` to `StaticSetOfInts` (page 99) that finds the number of occurrences of a given key in time proportional to $\log N$ in the worst case.

1.4.12 Write a program that, given two sorted arrays of N int values, prints all elements that appear in both arrays, in sorted order. The running time of your program should be proportional to N in the worst case.

1.4.13 Using the assumptions developed in the text, give the amount of memory needed to represent an object of each of the following types:

- a. Accumulator
- b. Transaction
- c. FixedCapacityStackOfStrings with capacity C and N entries
- d. Point2D
- e. Interval1D
- f. Interval2D
- g. Double

CREATIVE PROBLEMS

1.4.14 *4-sum*. Develop an algorithm for the *4-sum* problem.

1.4.15 *Faster 3-sum*. As a warmup, develop an implementation `TwoSumFaster` that uses a *linear* algorithm to count the pairs that sum to zero after the array is sorted (instead of the binary-search-based linearithmic algorithm). Then apply a similar idea to develop a quadratic algorithm for the 3-sum problem.

1.4.16 *Closest pair (in one dimension)*. Write a program that, given an array `a[]` of N `double` values, finds a *closest pair*: two values whose difference is no greater than the the difference of any other pair (in absolute value). The running time of your program should be linearithmic in the worst case.

1.4.17 *Farthest pair (in one dimension)*. Write a program that, given an array `a[]` of N `double` values, finds a *farthest pair*: two values whose difference is no smaller than the the difference of any other pair (in absolute value). The running time of your program should be linear in the worst case.

1.4.18 *Local minimum of an array*. Write a program that, given an array `a[]` of N distinct integers, finds a *local minimum*: an index i such that $a[i-1] < a[i] < a[i+1]$. Your program should use $\sim 2 \lg N$ compares in the worst case..

Answer: Examine the middle value $a[N/2]$ and its two neighbors $a[N/2 - 1]$ and $a[N/2 + 1]$. If $a[N/2]$ is a local minimum, stop; otherwise search in the half with the smaller neighbor.

1.4.19 *Local minimum of a matrix*. Given an N -by- N array `a[]` of N^2 distinct integers, design an algorithm that runs in time proportional to N to find a *local minimum*: a pair of indices i and j such that $a[i][j] < a[i+1][j]$, $a[i][j] < a[i][j+1]$, $a[i][j] < a[i-1][j]$, and $a[i][j] < a[i][j-1]$. The running time of your program should be proportional to N in the worst case.

1.4.20 *Bitonic search*. An array is *bitonic* if it is comprised of an increasing sequence of integers followed immediately by a decreasing sequence of integers. Write a program that, given a bitonic array of N distinct `int` values, determines whether a given integer is in the array. Your program should use $\sim 3 \lg N$ compares in the worst case.

1.4.21 *Binary search on distinct values*. Develop an implementation of binary search for `StaticSETofInts` (see page 98) where the running time of `contains()` is guaranteed

to be $\sim \lg R$, where R is the number of different integers in the array given as argument to the constructor.

1.4.22 *Binary search with only addition and subtraction.* [Mihai Patrascu] Write a program that, given an array of N distinct `int` values in ascending order, determines whether a given integer is in the array. You may use only additions and subtractions and a constant amount of extra memory. The running time of your program should be proportional to $\log N$ in the worst case.

Answer: Instead of searching based on powers of two (binary search), use Fibonacci numbers (which also grow exponentially). Maintain the current search range to be the interval $[i, i + F_k]$ and keep F_k and F_{k-1} in two variables. At each step compute F_{k-2} via subtraction, check element $i + F_{k-2}$, and update the current range to either $[i, i + F_{k-2}]$ or $[i + F_{k-2}, i + F_{k-2} + F_{k-1}]$.

1.4.23 *Binary search for a fraction.* Devise a method that uses a logarithmic number of queries of the form *Is the number less than x ?* to find a rational number p/q such that $0 < p < q < N$. *Hint:* Two fractions with denominators less than N cannot differ by more than $1/N^2$.

1.4.24 *Throwing eggs from a building.* Suppose that you have an N -story building and plenty of eggs. Suppose also that an egg is broken if it is thrown off floor F or higher, and unhurt otherwise. First, devise a strategy to determine the value of F such that the number of broken eggs is $\sim \lg N$ when using $\sim \lg N$ throws, then find a way to reduce the cost to $\sim 2 \lg F$.

1.4.25 *Throwing two eggs from a building.* Consider the previous question, but now suppose you only have two eggs, and your cost model is the number of throws. Devise a strategy to determine F such that the number of throws is at most $2\sqrt{N}$, then find a way to reduce the cost to $\sim c\sqrt{F}$. This is analogous to a situation where search hits (egg intact) are much cheaper than misses (egg broken).

1.4.26 *3-collinearity.* Suppose that you have an algorithm that takes as input N distinct points in the plane and can return the number of triples that fall on the same line. Show that you can use this algorithm to solve the 3-sum problem. *Strong hint:* Use algebra to show that (a, a^3) , (b, b^3) , and (c, c^3) are collinear if and only if $a + b + c = 0$.

1.4.27 *Queue with two stacks.* Implement a queue with two stacks so that each queue

CREATIVE PROBLEMS *(continued)*

operation takes a constant amortized number of stack operations. *Hint*: If you push elements onto a stack and then pop them all, they appear in reverse order. If you repeat this process, they're now back in order.

1.4.28 *Stack with a queue*. Implement a stack with a single queue so that each stack operations takes a linear number of queue operations. *Hint*: To delete an item, get all of the elements on the queue one at a time, and put them at the end, except for the last one which you should delete and return. (This solution is admittedly very inefficient.)

1.4.29 *Steque with two stacks*. Implement a steque with two stacks so that each steque operation (see EXERCISE 1.3.32) takes a constant amortized number of stack operations.

1.4.30 *Deque with a stack and a steque*. Implement a deque with a stack and a steque (see EXERCISE 1.3.32) so that each deque operation takes a constant amortized number of stack and steque operations.

1.4.31 *Deque with three stacks*. Implement a deque with three stacks so that each deque operation takes a constant amortized number of stack operations.

1.4.32 *Amortized analysis*. Prove that, starting from an empty stack, the number of array accesses used by any sequence of M operations in the resizing array implementation of Stack is proportional to M .

1.4.33 *Memory requirements on a 32-bit machine*. Give the memory requirements for Integer, Date, Counter, `int[]`, `double[]`, `double[][]`, String, Node, and Stack (linked-list representation) for a 32-bit machine. Assume that references are 4 bytes, object overhead is 8 bytes, and padding is to a multiple of 4 bytes.

1.4.34 *Hot or cold*. Your goal is to guess a secret integer between 1 and N . You repeatedly guess integers between 1 and N . After each guess you learn if your guess equals the secret integer (and the game stops). Otherwise, you learn if the guess is hotter (closer to) or colder (farther from) the secret number than your previous guess. Design an algorithm that finds the secret number in at most $\sim 2 \lg N$ guesses. Then design an algorithm that finds the secret number in at most $\sim 1 \lg N$ guesses.

1.4.35 *Time costs for pushdown stacks.* Justify the entries in the table below, which shows typical time costs for various pushdown stack implementations, using a cost model that counts both *data references* (references to data pushed onto the stack, either an array reference or a reference to an object's instance variable) and *objects created*.

data structure	item type	cost to push N int values	
		data references	objects created
<i>linked list</i>	int	$2N$	N
	Integer	$3N$	$2N$
<i>resizing array</i>	int	$\sim 5N$	$\lg N$
	Integer	$\sim 5N$	$\sim N$

Time costs for pushdown stacks (various implementations)

1.4.36 *Space usage for pushdown stacks.* Justify the entries in the table below, which shows typical space usage for various pushdown stack implementations. Use a static nested class for linked-list nodes to avoid the non-static nested class overhead.

data structure	item type	space usage for N int values (bytes)
<i>linked list</i>	int	$\sim 32N$
	Integer	$\sim 64N$
<i>resizing array</i>	int	between $\sim 4N$ and $\sim 16N$
	Integer	between $\sim 32N$ and $\sim 56N$

Space usage in pushdown stacks (various implementations)

EXPERIMENTS

1.4.37 *Autoboxing performance penalty.* Run experiments to determine the performance penalty on your machine for using autoboxing and auto-unboxing. Develop an implementation `FixedCapacityStackOfInts` and use a client such as `DoublingRatio` to compare its performance with the generic `FixedCapacityStack<Integer>`, for a large number of `push()` and `pop()` operations.

1.4.38 *Naive 3-sum implementation.* Run experiments to evaluate the following implementation of the inner loop of `ThreeSum`:

```
for (int i = 0; i < N; i++)
    for (int j = 0; j < N; j++)
        for (int k = 0; k < N; k++)
            if (i < j && j < k)
                if (a[i] + a[j] + a[k] == 0)
                    cnt++;
```

Do so by developing a version of `DoublingTest` that computes the ratio of the running times of this program and `ThreeSum`.

1.4.39 *Improved accuracy for doubling test.* Modify `DoublingRatio` to take a second command-line argument that specifies the number of calls to `timeTrial()` for each value of N . Run your program for 10, 100, and 1,000 trials and comment on the precision of the results.

1.4.40 *3-sum for random values.* Formulate and validate a hypothesis describing the number of triples of N random `int` values that sum to 0. If you are skilled in mathematical analysis, develop an appropriate mathematical model for this problem, where the values are uniformly distributed between $-M$ and M , where M is not small.

1.4.41 *Running times.* Estimate the amount of time it would take to run `TwoSumFast`, `TwoSum`, `ThreeSumFast` and `ThreeSum` on your computer to solve the problems for a file of 1 million numbers. Use `DoublingRatio` to do so.

1.4.42 *Problem sizes.* Estimate the size of the largest value of P for which you can run `TwoSumFast`, `TwoSum`, `ThreeSumFast`, and `ThreeSum` on your computer to solve the problems for a file of 2^P thousand numbers. Use `DoublingRatio` to do so.

1.4.43 *Resizing arrays versus linked lists.* Run experiments to validate the hypothesis that resizing arrays are faster than linked lists for stacks (see EXERCISE 1.4.35 and EXERCISE 1.4.36). Do so by developing a version of `DoublingRatio` that computes the ratio

of the running times of the two programs.

1.4.44 *Birthday problem.* Write a program that takes an integer N from the command line and uses `StdRandom.uniform()` to generate a random sequence of integers between 0 and $N - 1$. Run experiments to validate the hypothesis that the number of integers generated before the first repeated value is found is $\sim\sqrt{\pi N/2}$.

1.4.45 *Coupon collector problem.* Generating random integers as in the previous exercise, run experiments to validate the hypothesis that the number of integers generated before all possible values are generated is $\sim NH_N$.

1.5 CASE STUDY: UNION-FIND

TO ILLUSTRATE our basic approach to developing and analyzing algorithms, we now consider a detailed example. Our purpose is to emphasize the following themes.

- Good algorithms can make the difference between being able to solve a practical problem and not being able to address it at all.
- An efficient algorithm can be as simple to code as an inefficient one.
- Understanding the performance characteristics of an implementation can be an interesting and satisfying intellectual challenge.
- The scientific method is an important tool in helping us choose among different methods for solving the same problem.
- An iterative refinement process can lead to increasingly efficient algorithms.

These themes are reinforced throughout the book. This prototypical example sets the stage for our use of the same general methodology for many other problems.

The problem that we consider is not a toy problem; it is a fundamental computational task, and the solution that we develop is of use in a variety of applications, from percolation in physical chemistry to connectivity in communications networks. We start with a simple solution, then seek to understand that solution's performance characteristics, which help us to see how to improve the algorithm.

Dynamic connectivity We start with the following problem specification: The input is a sequence of pairs of integers, where each integer represents an object of some type and we are to interpret the pair $p\ q$ as meaning “ p is connected to q .” We assume that “is connected to” is an *equivalence* relation, which means that it is

- *Reflexive*: p is connected to p .
- *Symmetric*: If p is connected to q , then q is connected to p .
- *Transitive*: If p is connected to q and q is connected to r , then p is connected to r .

An equivalence relation partitions the objects into *equivalence classes*. In this case, two objects are in the same equivalence class if and only if they are connected. Our goal is to write a program to filter out extraneous pairs (pairs where both objects are in the same equivalence class) from the sequence. In other words, when the program reads a pair $p\ q$ from the input, it should write the pair to the output only if the pairs it has seen to that point *do not* imply that p is connected to q . If the previous pairs *do* imply that p is connected to q , then the program should ignore the pair $p\ q$ and proceed to read in the next pair. The figure on the facing page gives an example of this process. To achieve the desired goal, we need to devise a data structure that can remember sufficient

information about the pairs it has seen to be able to decide whether or not a new pair of objects is connected. Informally, we refer to the task of designing such a method as the *dynamic connectivity* problem. This problem arises applications such as the following:

Networks. The integers might represent computers in a large network, and the pairs might represent connections in the network. Then, our program determines whether we need to establish a new direct connection for p and q to be able to communicate or whether we can use existing connections to set up a communications path. Or, the integers might represent contact sites in an electrical circuit, and the pairs might represent wires connecting the sites. Or, the integers might represent people in a social network, and the pairs might represent friendships. In such applications, we might need to process millions of objects and billions of connections.

Variable-name equivalence. In certain programming environments, it is possible to declare two variable names as being equivalent (references to the same object). After a sequence of such declarations, the system needs to be able to determine whether two given names are equivalent. This application is an early one (for the FORTRAN programming language) that motivated the development of the algorithms that we are about to consider.

Mathematical sets. On a more abstract level, you can think of the integers as belonging to mathematical sets. When we process a pair p q , we are asking whether they belong to the same set. If not, we unite p 's set and q 's set, putting them in the same set.

TO FIX IDEAS, we will use networking terminology for the rest of this section and refer to the objects as *sites*, the pairs as *connections*, and the equivalence classes as *connected components*, or just *components* for short. For simplicity, we assume that we have N sites with integer names, from 0 to $N-1$. We do so without loss of generality because we shall be considering a host of algorithms in CHAPTER 3 that can associate arbitrary names with such integer identifiers in an efficient manner.

A larger example that gives some indication of the difficulty of the connectivity problem is depicted in the figure at the top of the next page. You can quickly identify the component consisting of a single site in the left middle of the diagram and the

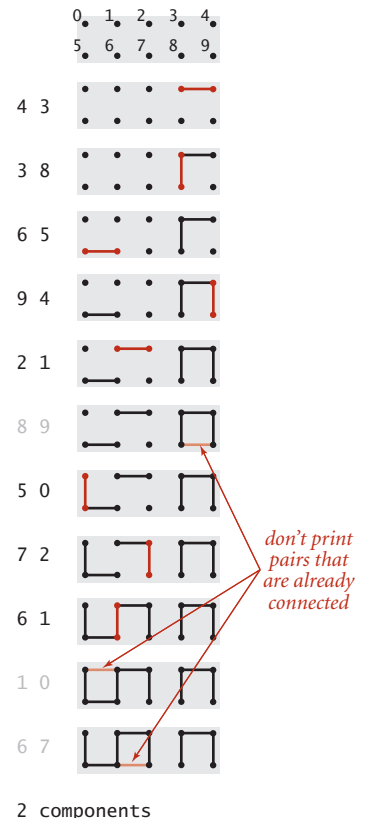

Dynamic connectivity example

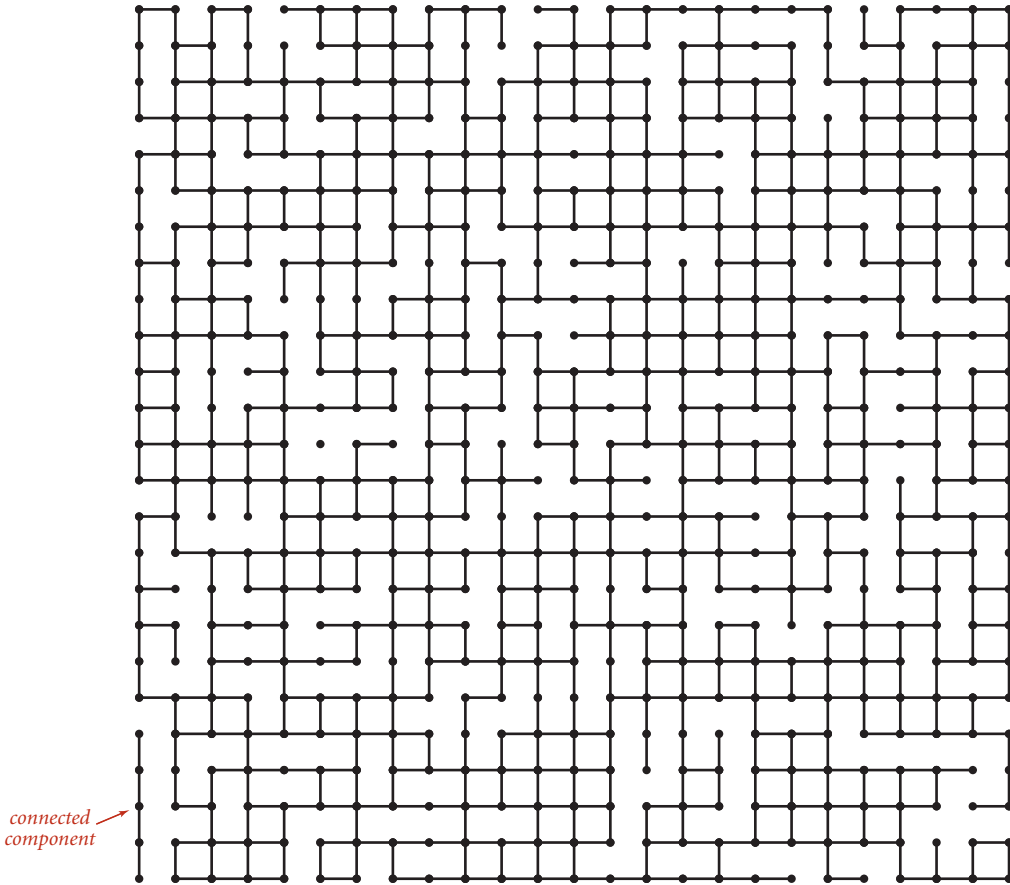

Medium connectivity example (625 sites, 900 edges, 3 connected components)

component consisting of five sites at the bottom left, but you might have difficulty verifying that all of the other sites are connected to one another. For a program, the task is even more difficult, because it has to work just with site names and connections and has no access to the geometric placement of sites in the diagram. How can we tell quickly whether or not any given two sites in such a network are connected?

The first task that we face in developing an algorithm is to specify the problem in a precise manner. The more we require of an algorithm, the more time and space we may expect it to need to finish the job. It is impossible to quantify this relationship *a priori*, and we often modify a problem specification on finding that it is difficult or expensive to solve or, in happy circumstances, on finding that an algorithm can provide information more useful than what was called for in the original specification. For example, our

connectivity problem specification requires only that our program be able to determine whether or not any given pair p q is connected, and not that it be able to demonstrate a set of connections that connect that pair. Such a requirement makes the problem more difficult and leads us to a different family of algorithms, which we consider in SECTION 4.1.

To specify the problem, we develop an API that encapsulates the basic operations that we need: initialize, add a connection between two sites, identify the component containing a site, determine whether two sites are in the same component, and count the number of components. Thus, we articulate the following API:

```
public class UF
```

```

    UF(int N)                initialize N sites with integer names (0 to N-1)
    void union(int p, int q) add connection between p and q
    int find(int p)          component identifier for p (0 to N-1)
    boolean connected(int p, int q) return true if p and q are in the same component
    int count()              number of components

```

Union-find API

The `union()` operation merges two components if the two sites are in different components, the `find()` operation returns an integer component identifier for a given site, the `connected()` operation determines whether two sites are in the same component, and the `count()` method returns the number of components. We start with N components, and each `union()` that merges two different components decrements the number of components by 1.

As we shall soon see, the development of an algorithmic solution for dynamic connectivity thus reduces to the task of developing an implementation of this API. Every implementation has to

- Define a data structure to represent the known connections
- Develop efficient `union()`, `find()`, `connected()`, and `count()` implementations that are based on that data structure

As usual, the nature of the data structure has a direct impact on the efficiency of the algorithms, so data structure and algorithm design go hand in hand. The API already specifies the convention that both sites and components will be identified by `int` values between 0 and $N-1$, so it makes sense to use a *site-indexed array* `id[]` as our basic

data structure to represent the components. We always use the name of one of the sites in a component as the component identifier, so you can think of each component as being represented by one of its sites. Initially, we start with N components, each site in its own component, so we initialize $\text{id}[i]$ to i for all i from 0 to $N-1$. For each site i , we keep the information needed by $\text{find}()$ to determine the component containing i in $\text{id}[i]$, using various algorithm-dependent strategies. All of our implementations use a one-line implementation of $\text{connected}()$ that returns the boolean value $\text{find}(p) == \text{find}(q)$.

```
% more tinyUF.txt
10
4 3
3 8
6 5
9 4
2 1
8 9
5 0
7 2
6 1
1 0
6 7

% more mediumUF.txt
625
528 503
548 523
...
[900 connections]

% more largeUF.txt
1000000
786321 134521
696834 98245
...
[2000000 connections]
```

IN SUMMARY, our starting point is ALGORITHM 1.5 on the facing page. We maintain two instance variables, the count of components and the array $\text{id}[]$. Implementations of $\text{find}()$ and $\text{union}()$ are the topic of the remainder of this section.

To test the utility of the API and to provide a basis for development, we include a client in $\text{main}()$ that uses it to solve the dynamic connectivity problem. It reads the value of N followed by a sequence of pairs of integers (each in the range 0 to $N-1$), calling $\text{find}()$ for each pair: If the two sites in the pair are already connected, it moves on to the next pair; if they are not, it calls $\text{union}()$ and prints the pair. Before considering implementations, we also prepare test data: the file `tinyUF.txt` contains the 11 connections among 10 sites used in the small example illustrated on page 217, the file `mediumUF.txt` contains the 900 connections among 625 sites illustrated on page 218, and the file `largeUF.txt` is an example with 2 million connections among 1 millions sites. Our goal is to be able to handle inputs such as `largeUF.txt` in a reasonable amount of time.

To analyze the algorithms, we focus on the number of times each algorithm accesses an array entry. By doing so, we are implicitly formulating the hypothesis that the running times of the algorithms on a particular machine are within a constant factor of

this quantity. This hypothesis is immediate from the code, is not difficult to validate through experimentation, and provides a useful starting point for comparing algorithms, as we will see.

Union-find cost model. When studying algorithms to implement the union-find API, we count *array accesses* (the number of times an array entry is accessed, for read or write).

ALGORITHM 1.5 Union-find implementation

```

public class UF
{
    private int[] id;    // access to component id (site indexed)
    private int count;  // number of components

    public UF(int N)
    { // Initialize component id array.
        count = N;
        id = new int[N];
        for (int i = 0; i < N; i++)
            id[i] = i;
    }

    public int count()
    { return count; }

    public boolean connected(int p, int q)
    { return find(p) == find(q); }

    public int find(int p)
    public void union(int p, int q)
// See page 222 (quick-find), page 224 (quick-union) and page 228 (weighted).

    public static void main(String[] args)
    { // Solve dynamic connectivity problem on StdIn.
        int N = StdIn.readInt();           // Read number of sites.
        UF uf = new UF(N);                 // Initialize N components.
        while (!StdIn.isEmpty())
        {
            int p = StdIn.readInt();
            int q = StdIn.readInt();       // Read pair to connect.
            if (uf.connected(p, q)) continue; // Ignore if connected.
            uf.union(p, q);                // Combine components
            StdOut.println(p + " " + q);    // and print connection.
        }
        StdOut.println(uf.count() + " components");
    }
}

```

```

% java UF < tinyUF.txt
4 3
3 8
6 5
9 4
2 1
5 0
7 2
6 1
2 components

```

Our UF implementations are based on this code, which maintains an array of integers `id[]` such that the `find()` method returns the same integer for every site in each connected component. The `union()` method must maintain this invariant.

Implementations We shall consider three different implementations, all based on using the site-indexed `id[]` array, to determine whether two sites are in the same connected component.

Quick-find. One approach is to maintain the invariant that `p` and `q` are connected if and only if `id[p]` is equal to `id[q]`. In other words, all sites in a component must have the same value in `id[]`. This method is called *quick-find* because `find(p)` just returns `id[p]`, which immediately implies that `connected(p, q)` reduces to just the test `id[p] == id[q]` and returns `true` if and only if `p` and `q` are in the same component. To maintain the invariant for the call `union(p, q)`, we first check whether they are already in the same component, in which case there is nothing to do. Otherwise, we are faced with the situation that all of the `id[]` entries corresponding to sites in the same component as `p` have one value and all of the `id[]` entries corresponding to sites in the same component as `q` have another value. To combine the two components into one, we have to make all of the `id[]` entries corresponding to both sets of sites the same value, as shown in the example at right. To do so, we go through the array, changing all the entries with values equal to `id[p]` to the value `id[q]`. We could have decided to change all the entries equal to `id[q]` to the value `id[p]`—the choice between these two alternatives

find examines id[5] and id[9]

p	q	0	1	2	3	4	5	6	7	8	9
5	9	1	1	1	8	8	1	1	1	8	8

union has to change all 1s to 8s

p	q	0	1	2	3	4	5	6	7	8	9
5	9	1	1	1	8	8	1	1	1	8	8
		8	8	8	8	8	8	8	8	8	8

Quick-find overview

is arbitrary. The code for `find()` and `union()` based on these descriptions, given at left, is straightforward. A full trace for our development client with our sample test data `tinyUF.txt` is shown on the next page.

```
public int find(int p)
{ return id[p]; }

public void union(int p, int q)
{ // Put p and q into the same component.
  int pID = find(p);
  int qID = find(q);

  // Nothing to do if p and q are already
  //   in the same component.
  if (pID == qID) return;

  // Rename p's component to q's name.
  for (int i = 0; i < id.length; i++)
    if (id[i] == pID) id[i] = qID;
  count--;
}
```

Quick-find

Quick-find analysis. The `find()` operation is certainly quick, as it only accesses the `id[]` array once in order to complete the operation. But quick-find is typically not useful for large problems because `union()` needs to scan through the whole `id[]` array for each input pair.

Proposition F. The quick-find algorithm uses one array access for each call to `find()` and between $N + 3$ and $2N + 1$ array accesses for each call to `union()` that combines two components.

Proof: Immediate from the code. Each call to `connected()` tests two entries in the `id[]` array, one for each of the two calls to `find()`. Each call to `union()` that combines two components does so by making two calls to `find()`, testing each of the N entries in the `id[]` array, and changing between 1 and $N - 1$ of them.

p	q	id[]									
4	3	0	1	2	3	4	5	6	7	8	9
3	8	0	1	2	3	3	5	6	7	8	9
6	5	0	1	2	8	8	5	6	7	8	9
9	4	0	1	2	8	8	5	5	7	8	9
2	1	0	1	2	8	8	5	5	7	8	8
8	9	0	1	1	8	8	5	5	7	8	8
5	0	0	1	1	8	8	5	5	7	8	8
7	2	0	1	1	8	8	0	0	7	8	8
6	1	0	1	1	8	8	0	0	1	8	8
1	0	1	1	1	8	8	1	1	1	8	8
6	7	1	1	1	8	8	1	1	1	8	8

id[p] and id[q] differ, so union() changes entries equal to id[p] to id[q] (in red)
id[p] and id[q] match, so no change

Quick-find trace

In particular, suppose that we use quick-find for the dynamic connectivity problem and wind up with a single component. This requires at least $N - 1$ calls to `union()`, and, consequently, at least $(N + 3)(N - 1) \sim N^2$ array accesses—we are led immediately to the hypothesis that dynamic connectivity with quick-find can be a *quadratic*-time process. This analysis generalizes to say that quick-find is quadratic for typical applications where we end up with a small number of components. You can easily validate this hypothesis on your computer with a doubling test (see EXERCISE 1.5.23 for an instructive example). Modern computers can execute hundreds of millions or billions of instructions per second, so this cost is not noticeable if N is small, but we also might find ourselves with millions or billions of sites and connections to process in a modern application, as represented by our test file `largeUF.txt`. If you are still not convinced and feel that you have a particularly fast computer, try using quick-find to determine the number of components implied by the pairs in `largeUF.txt`. The inescapable conclusion is that we cannot feasibly solve such a problem using the quick-find algorithm, so we seek better algorithms.

Quick-union. The next algorithm that we consider is a complementary method that concentrates on speeding up the union() operation. It is based on the same data structure—the site-indexed id[] array—but we interpret the values differently, to define more complicated structures. Specifically, the id[] entry for each site is the name of another site in the same component (possibly itself)—we refer to this connection as a *link*. To implement find(), we start at the given site, follow its link to another site, follow that site’s link to yet another site, and so forth, following links until reaching a *root*, a site that has a link to itself (which is guaranteed to happen, as you will see). Two sites are in the same component if and only if this process leads them to the same root. To validate this process, we need union(p, q) to maintain this invariant, which is easily arranged: we follow links to find the roots associated with p and q, then rename one of the components by linking one of these roots to the other; hence the name *quick-union*. Again, we have an arbitrary choice of whether to rename the component containing p or the component containing q; the implementation above renames the one containing p. The figure on the next page shows a trace of the quick-union algorithm for tinyUF.txt. This trace is best understood in terms of the graphical representation depicted at left, which we consider next.

```
private int find(int p)
{ // Find component name.
  while (p != id[p]) p = id[p];
  return p;
}

public void union(int p, int q)
{ // Give p and q the same root.
  int pRoot = find(p);
  int qRoot = find(q);
  if (pRoot == qRoot) return;

  id[pRoot] = qRoot;
  count--;
}
```

Quick-union

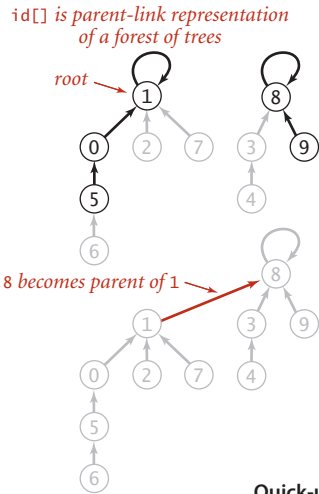

find has to follow links to the root

p	q	0	1	2	3	4	5	6	7	8	9
5	9	1	1	1	8	3	0	5	1	8	8

find(5) is id[id[id[5]]] *find(9) is id[id[9]]*

union changes just one link

p	q	0	1	2	3	4	5	6	7	8	9	
5	9	1	1	1	8	3	0	5	1	8	8	
			1	8	1	8	3	0	5	1	8	8

Quick-union overview

Forest-of-trees representation. The code for quick-union is compact, but a bit opaque. Representing sites as *nodes* (labeled circles) and links as arrows from one node to another gives a graphical representation of the data structure that makes it relatively easy to understand the operation of the algorithm. The resulting structures are *trees*—in

technical terms, our `id[]` array is a parent-link representation of a forest (set) of trees. To simplify the diagrams, we often omit both the arrowheads in the links (because they all point upwards) and the self-links in the roots of the trees. The forests corresponding to the `id[]` array for `tinyUF.txt` are shown at right. When we start at the node corresponding to any site and follow links, we eventually end up at the root of the tree containing that node. We can prove this property to be true by induction: It is true after the array is initialized to have every node link to itself, and if it is true before a given `union()` operation, it is certainly true afterward. Thus, the `find()` method on page 224 returns the name of the site at the root (so that `connected()` checks whether two sites are in the same tree). This representation is useful for this problem because the nodes corresponding to two sites are in the same tree if and only if the sites are in the same component.

Moreover, the trees are not difficult to build: the `union()` implementation on page 224 combines two trees into one in a single statement, by making the root of one the parent of the other.

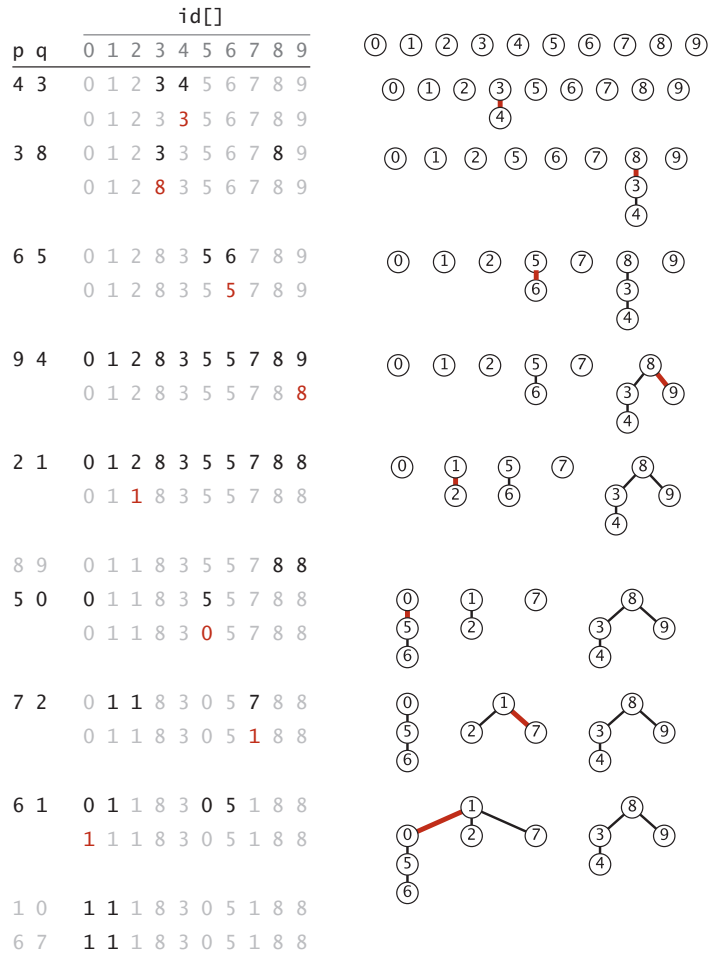

Quick-union trace (with corresponding forests of trees)

Quick-union analysis. The quick-union algorithm would seem to be faster than the quick-find algorithm, because it does not have to go through the entire array for each

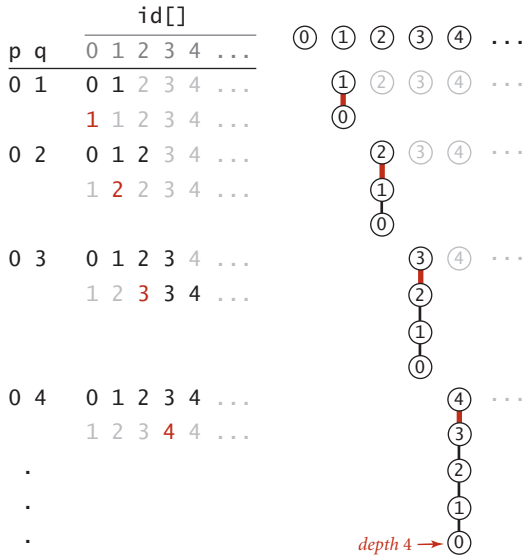

Quick-union worst case

input pair; but how much faster is it? Analyzing the cost of quick-union is more difficult than it was for quick-find, because the cost is more dependent on the nature of the input. In the best case, `find()` just needs one array access to find the identifier associated with a site, as in quick-find; in the worst case, it needs $2N + 1$ array accesses, as for 0 in the example at left (this count is conservative since compiled code will typically *not* do an array access for the second reference to `id[p]` in the `while` loop). Accordingly, it is not difficult to construct a best-case input for which the running time of our dynamic connectivity client is linear; on the other hand it is also not difficult to construct a worst-case input for which the running time is quadratic (see the diagram at left and PROPOSITION G below). Fortunately, we do not need to face the problem of analyzing quick union and we will not dwell on comparative performance of quick-find and quick-union because

we will next examine another variant that is far more efficient than either. For the moment, you can regard quick-union as an improvement over quick-find because it removes quick-find's main liability (that `union()` always takes linear time). This difference certainly represents an improvement for typical data, but quick-union still has the liability that we cannot *guarantee* it to be substantially faster than quick-find in every case (for certain input data, quick-union is no faster than quick-find).

Definition. The *size* of a tree is its number of nodes. The *depth* of a node in a tree is the number of links on the path from it to the root. The *height* of a tree is the maximum depth among its nodes.

Proposition G. The number of array accesses used by `find()` in quick-union is 1 plus the twice the depth of the node corresponding to the given site. The number of array accesses used by `union()` and `connected()` is the cost of the two `find()` operations (plus 1 for `union()` if the given sites are in different trees).

Proof: Immediate from the code.

Again, suppose that we use quick-union for the dynamic connectivity problem and wind up with a single component. An immediate implication of PROPOSITION 6 is that the running time is quadratic, in the worst case. Suppose that the input pairs come in the order 0-1, then 0-2, then 0-3, and so forth. After $N - 1$ such pairs, we have N sites all in the same set, and the tree that is formed by the quick-union algorithm has height $N - 1$, with 0 linking to 1, which links to 2, which links to 3, and so forth (see the diagram on the facing page). By PROPOSITION 6, the number of array accesses for the `union()` operation for the pair 0 i is exactly $2i + 2$ (site 0 is at depth i and site i at depth 0). Thus, the total number of array accesses for the `find()` operations for these N pairs is $2(1 + 2 + \dots + N) \sim N^2$.

Weighted quick-union. Fortunately, there is an easy modification to quick-union that allows us to guarantee that bad cases such as this one do not occur. Rather than arbitrarily connecting the second tree to the first for `union()`, we keep track of the *size* of each tree and always connect the smaller tree to the larger. This change requires slightly more code and another array to hold the node counts, as shown on page 228, but it leads to substantial improvements in efficiency. We refer to this algorithm as the *weighted quick-union* algorithm. The forest of trees constructed by this algorithm for `tinyUF.txt` is shown in the figure at left on the top of page 229. Even for this small example, the tree height is substantially smaller than the height for the unweighted version.

Weighted quick-union analysis. The figure at right on the top of page 229 illustrates the worst case for weighted quick union, when the sizes of the trees to be merged by `union()` are always equal (and a power of 2). These tree structures look complex, but they have the simple property that the height of a tree of 2^n nodes is n . Furthermore, when we merge two trees of 2^n nodes, we get a tree of 2^{n+1} nodes, and we increase the height of the tree to $n + 1$. This observation generalizes to provide a proof that the weighted algorithm can guarantee *logarithmic* performance.

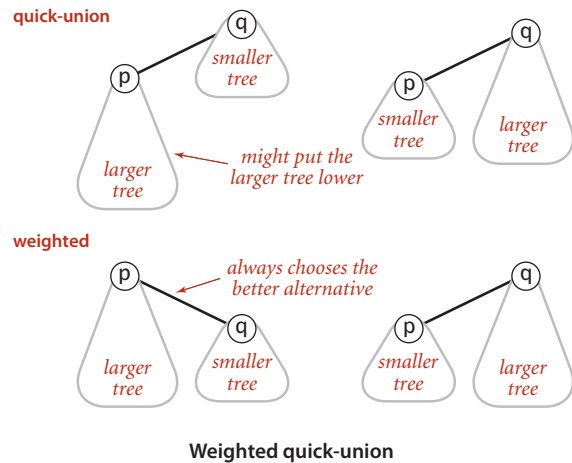

```
% java WeightedQuickUnionUF < mediumUF.txt
528 503
548 523
...
3 components

% java WeightedQuickUnionUF < largeUF.txt
786321 134521
696834 98245
...
6 components
```

ALGORITHM 1.5 (continued) Union-find implementation (weighted quick-union)

```

public class WeightedQuickUnionUF
{
    private int[] id;      // parent link (site indexed)
    private int[] sz;      // size of component for roots (site indexed)
    private int count;     // number of components

    public WeightedQuickUnionUF(int N)
    {
        count = N;
        id = new int[N];
        for (int i = 0; i < N; i++) id[i] = i;
        sz = new int[N];
        for (int i = 0; i < N; i++) sz[i] = 1;
    }

    public int count()
    { return count; }

    public boolean connected(int p, int q)
    { return find(p) == find(q); }

    private int find(int p)
    { // Follow links to find a root.
      while (p != id[p]) p = id[p];
      return p;
    }

    public void union(int p, int q)
    {
        int i = find(p);
        int j = find(q);
        if (i == j) return;

        // Make smaller root point to larger one.
        if (sz[i] < sz[j]) { id[i] = j; sz[j] += sz[i]; }
        else                { id[j] = i; sz[i] += sz[j]; }
        count--;
    }
}

```

This code is best understood in terms of the forest-of-trees representation described in the text. We add a site-indexed array `sz[]` as an instance variable so that `union()` can link the root of the smaller tree to the root of the larger tree. This addition makes it feasible to address large problems.

reference input

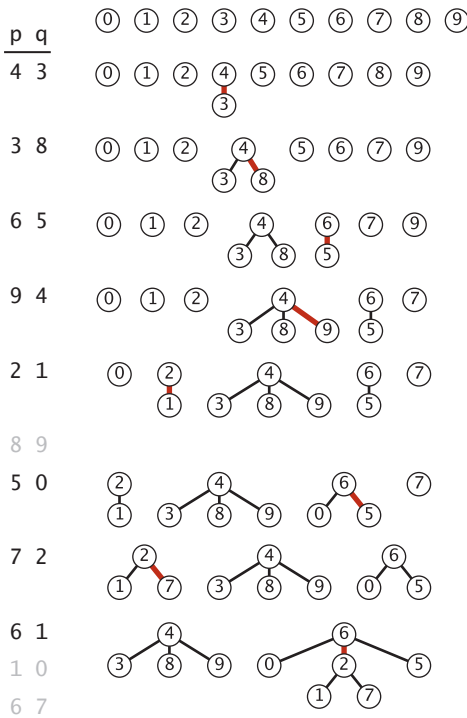

worst-case input

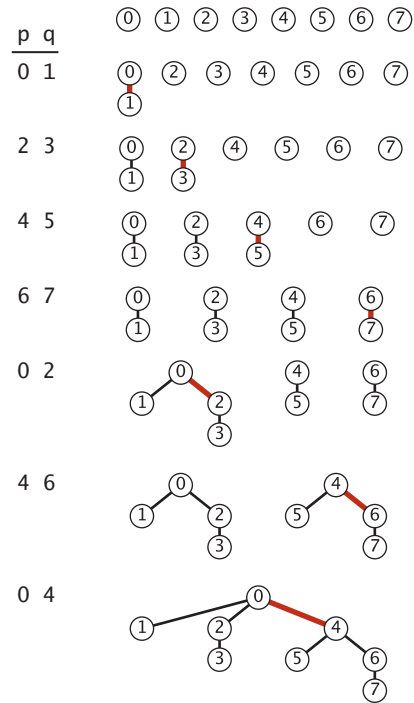

Weighted quick-union traces (forests of trees)

Proposition H. The depth of any node in a forest built by weighted quick-union for N sites is at most $\lg N$.

Proof: We prove a stronger fact by (strong) induction: The height of every tree of size k in the forest is at most $\lg k$. The base case follows from the fact that the tree height is 0 when k is 1. By the inductive hypothesis, assume that the tree height of a tree of size i is at most $\lg i$ for all $i < k$. When we combine a tree of size i with a tree of size j with $i \leq j$ and $i + j = k$, we increase the depth of each node in the smaller set by 1, but they are now in a tree of size $i + j = k$, so the property is preserved because $1 + \lg i = \lg(i + i) \leq \lg(i + j) = \lg k$.

quick-union

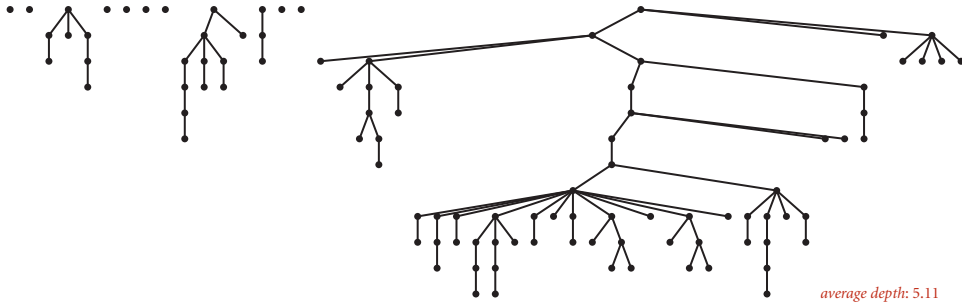

weighted



Quick-union and weighted quick-union (100 sites, 88 union() operations)

Corollary. For weighted quick-union with N sites, the worst-case order of growth of the cost of `find()`, `connected()`, and `union()` is $\log N$.

Proof. Each operation does at most a constant number of array accesses for each node on the path from a node to a root in the forest.

For dynamic connectivity, the practical implication of PROPOSITION H and its corollary is that weighted quick-union is the only one of the three algorithms that can feasibly be used for huge practical problems. The weighted quick-union algorithm uses *at most* $c M \lg N$ array accesses to process M connections among N sites for a small constant c . This result is in stark contrast to our finding that quick-find always (and quick-union sometimes) uses *at least* MN array accesses. Thus, with weighted quick-union, we can guarantee that we can solve huge practical dynamic connectivity problems in a reasonable amount of time. For the price of a few extra lines of code, we get a program that can be millions of times faster than the simpler algorithms for the huge dynamic connectivity problems that we might encounter in practical applications.

A 100-site example is shown on the top of this page. It is evident from this diagram that relatively few nodes fall far from the root with weighted quick-union. Indeed it is frequently the case that a 1-node tree is merged with a larger tree, which puts the node just one link from the root. Empirical studies on huge problems tell us that weighted quick-union typically solves practical problems in *constant* time per operation. We could hardly expect to find a more efficient algorithm.

algorithm	order of growth for N sites (worst case)		
	constructor	union	find
<i>quick-find</i>	N	N	1
<i>quick-union</i>	N	tree height	tree height
<i>weighted quick-union</i>	N	$\lg N$	$\lg N$
<i>weighted quick-union with path compression</i>	N	very, very nearly, but not quite 1 (amortized) (see EXERCISE 1.5.13)	
<i>impossible</i>	N	1	1

Performance characteristics of union-find algorithms

Optimal algorithms. Can we find an algorithm that has *guaranteed* constant-time-per-operation performance? This question is an extremely difficult one that plagued researchers for many years. In pursuit of an answer, a number of variations of quick-union and weighted quick-union have been studied. For example, the following method, known as *path compression*, is easy to implement. Ideally, we would like every node to link directly to the root of its tree, but we do not want to pay the price of changing a large number of links, as we did in the quick-find algorithm. We can approach the ideal simply by making all the nodes that we *do* examine directly link to the root. This step seems drastic at first blush, but it is easy to implement, and there is nothing sacrosanct about the structure of these trees: if we can modify them to make the algorithm more efficient, we should do so. To implement path compression, we just add another loop to `find()` that sets the `id[]` entry corresponding to each node encountered along the way to link directly to the root. The net result is to flatten the trees almost completely, approximating the ideal achieved by the quick-find algorithm. The method is simple and effective, but you are not likely to be able to discern any improvement over weighted quick-union in a practical situation (see EXERCISE 1.5.24). Theoretical results about the situation are extremely complicated and quite remarkable. *Weighted quick union with path compression is optimal but not quite constant-time per operation.* That is, not only is weighted quick-find with path compression not constant-time per operation in the worst case (amortized), but also there exists *no* algorithm that can guarantee to perform each union-find operation in amortized constant time (under the very general “cell probe” model of computation). Weighted quick-union with path compression is very close to the best that we can do for this problem.

Amortized cost plots. As with any data type implementation, it is worthwhile to run experiments to test the validity of our performance hypotheses for typical clients, as dis-

ussion in SECTION 1.4. The figure at left shows details of the performance of the algorithms for our dynamic connectivity development client when solving our 625-site connectivity example (`mediumUF.txt`). Such diagrams are easy to produce (see EXERCISE 1.5.16): For the i th connection processed, we maintain a variable `cost` that counts the number of array accesses (to `id[]` or `sz[]`) and a variable `total` that is the sum of the total number of array accesses so far. Then we plot a gray dot at (i, cost) and a red dot at $(i, \text{total}/i)$. The red dots are the average cost per operation, or amortized cost. These plots provide good insights into algorithm behavior. For *quick-find*, every `union()` operation uses at least 625 accesses (plus 1 for each component merged, up to another 625) and every `connected()` operation uses 2 accesses. Initially, most of the connections lead to a call on `union()`, so the cumulative average hovers around 625; later, most connections are calls to `connected()` that cause the call to `union()` to be skipped, so the cumulative average decreases, but still remains relatively high. (Inputs that lead to a large number of `connected()` calls that cause `union()` to be skipped will exhibit significantly better performance—see EXERCISE 1.5.23 for an example). For *quick-union*, all operations initially require only a few array accesses; eventually, the height of the trees becomes a significant factor and the amortized cost grows noticeably. For *weighted quick-union*, the tree height stays small, none of the operations are expensive, and the amortized cost is low. These experiments

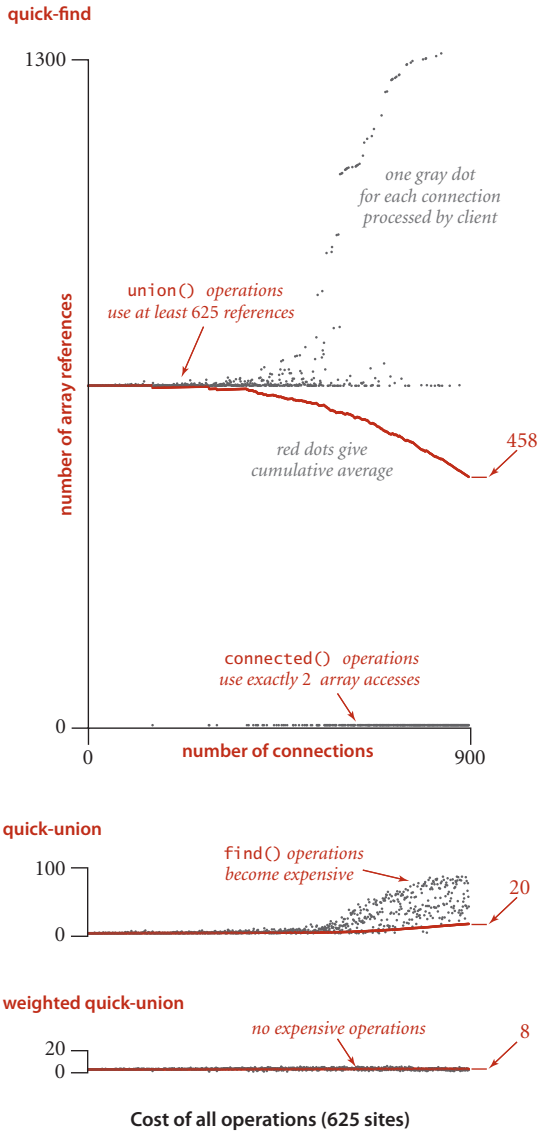

validate our conclusion that weighted quick-union is certainly worth implementing and that there is not much further room for improvement for practical problems.

Perspective Each of the UF implementations that we considered is an improvement over the previous in some intuitive sense, but the process is artificially smooth because we have the benefit of hindsight in looking over the development of the algorithms as they were studied by researchers over the years. The implementations are simple and the problem is well specified, so we can evaluate the various algorithms directly by running empirical studies. Furthermore, we can use these studies to validate mathematical results that quantify the performance of these algorithms. When possible, we follow the same basic steps for fundamental problems throughout the book that we have taken for union–find algorithms in this section, some of which are highlighted in this list:

- Decide on a complete and specific problem statement, including identifying fundamental abstract operations that are intrinsic to the problem and an API.
- Carefully develop a succinct implementation for a straightforward algorithm, using a well-thought-out development client and realistic input data.
- Know when an implementation could not possibly be used to solve problems on the scale contemplated and must be improved or abandoned.
- Develop improved implementations through a process of stepwise refinement, validating the efficacy of ideas for improvement through empirical analysis, mathematical analysis, or both.
- Find high-level abstract representations of data structures or algorithms in operation that enable effective high-level design of improved versions.
- Strive for worst-case performance guarantees when possible, but accept good performance on typical data when available.
- Know when to leave further improvements for detailed in-depth study to skilled researchers and move on to the next problem.

The potential for spectacular performance improvements for practical problems such as those that we saw for union–find makes algorithm design a compelling field of study. What other design activities hold the potential to reap savings factors of millions or billions, or more?

Developing an efficient algorithm is an intellectually satisfying activity that can have direct practical payoff. As the dynamic connectivity problem indicates, a simply stated problem can lead us to study numerous algorithms that are not only both useful and interesting, but also intricate and challenging to understand. We shall encounter many ingenious algorithms that have been developed over the years for a host of practical problems. As the scope of applicability of computational solutions to scientific and commercial problems widens, so also grows the importance of being able to use efficient algorithms to solve known problems and of being able to develop efficient solutions to new problems.

Q&A

Q. I'd like to add a `delete()` method to the API that allows clients to delete connections. Any advice on how to proceed?

A. No one has devised an algorithm as simple and efficient as the ones in this section that can handle deletions. This theme recurs throughout this book. Several of the data structures that we consider have the property that deleting something is much more difficult than adding something.

Q. What is the cell-probe model?

A. A model of computation where we only count accesses to a random-access memory large enough to hold the input and consider all other operations to be free.

EXERCISES

1.5.1 Show the contents of the `id[]` array and the number of times the array is accessed for each input pair when you use quick-find for the sequence 9-0 3-4 5-8 7-2 2-1 5-7 0-3 4-2.

1.5.2 Do EXERCISE 1.5.1, but use quick-union (page 224). In addition, draw the forest of trees represented by the `id[]` array after each input pair is processed.

1.5.3 Do EXERCISE 1.5.1, but use weighted quick-union (page 228).

1.5.4 Show the contents of the `sz[]` and `id[]` arrays and the number of array accesses for each input pair corresponding to the weighted quick-union examples in the text (both the reference input and the worst-case input).

1.5.5 Estimate the minimum amount of time (in days) that would be required for quick-find to solve a dynamic connectivity problem with 10^9 sites and 10^6 input pairs, on a computer capable of executing 10^9 instructions per second. Assume that each iteration of the inner for loop requires 10 machine instructions.

1.5.6 Repeat EXERCISE 1.5.5 for weighted quick-union.

1.5.7 Develop classes `QuickUnionUF` and `QuickFindUF` that implement quick-union and quick-find, respectively.

1.5.8 Give a counterexample that shows why this intuitive implementation of `union()` for quick-find is not correct:

```
public void union(int p, int q)
{
    if (connected(p, q)) return;

    // Rename p's component to q's name.
    for (int i = 0; i < id.length; i++)
        if (id[i] == id[p]) id[i] = id[q];
    count--;
}
```

1.5.9 Draw the tree corresponding to the `id[]` array depicted at right. Can this be the result of running weighted quick-union? Explain why this is impossible or give a sequence of operations that results in this array.

i	0	1	2	3	4	5	6	7	8	9
id[i]	1	1	3	1	5	6	1	3	4	5

EXERCISES *(continued)*

1.5.10 In the weighted quick-union algorithm, suppose that we set `id[find(p)]` to `q` instead of to `id[find(q)]`. Would the resulting algorithm be correct?

Answer: Yes, but it would increase the tree height, so the performance guarantee would be invalid.

1.5.11 Implement *weighted quick-find*, where you always change the `id[]` entries of the smaller component to the identifier of the larger component. How does this change affect performance?

CREATIVE PROBLEMS

1.5.12 *Quick-union with path compression.* Modify quick-union (page 224) to include *path compression*, by adding a loop to `union()` that links every site on the paths from `p` and `q` to the roots of their trees to the root of the new tree. Give a sequence of input pairs that causes this method to produce a path of length 4. *Note:* The amortized cost per operation for this algorithm is known to be logarithmic.

1.5.13 *Weighted quick-union with path compression.* Modify weighted quick-union (ALGORITHM 1.5) to implement path compression, as described in EXERCISE 1.5.12. Give a sequence of input pairs that causes this method to produce a tree of height 4. *Note:* The amortized cost per operation for this algorithm is known to be bounded by a function known as the *inverse Ackermann function* and is less than 5 for any conceivable practical value of N .

1.5.14 *Weighted quick-union by height.* Develop a UF implementation that uses the same basic strategy as weighted quick-union but keeps track of tree height and always links the shorter tree to the taller one. Prove a logarithmic upper bound on the height of the trees for N sites with your algorithm.

1.5.15 *Binomial trees.* Show that the number of nodes at each level in the worst-case trees for weighted quick-union are *binomial coefficients*. Compute the average depth of a node in a worst-case tree with $N = 2^n$ nodes.

1.5.16 *Amortized costs plots.* Instrument your implementations from EXERCISE 1.5.7 to make amortized costs plots like those in the text.

1.5.17 *Random connections.* Develop a UF client `ErdosRenyi` that takes an integer value N from the command line, generates random pairs of integers between 0 and $N-1$, calling `connected()` to determine if they are connected and then `union()` if not (as in our development client), looping until all sites are connected, and printing the number of connections generated. Package your program as a static method `count()` that takes N as argument and returns the number of connections and a `main()` that takes N from the command line, calls `count()`, and prints the returned value.

1.5.18 *Random grid generator.* Write a program `RandomGrid` that takes an `int` value N from the command line, generates all the connections in an N -by- N grid, puts them in random order, randomly orients them (so that `p < q` and `q < p` are equally likely to occur), and prints the result to standard output. To randomly order the connections, use a `RandomBag` (see EXERCISE 1.3.34 on page 167). To encapsulate `p` and `q` in a single object,

CREATIVE PROBLEMS *(continued)*

use the `Connection` nested class shown below. Package your program as two static methods: `generate()`, which takes `N` as argument and returns an array of connections, and `main()`, which takes `N` from the command line, calls `generate()`, and iterates through the returned array to print the connections.

1.5.19 *Animation.* Write a `RandomGrid` client (see EXERCISE 1.5.18) that uses `UnionFind` as in our development client to check connectivity and uses `StdDraw` to draw the connections as they are processed.

1.5.20 *Dynamic growth.* Using linked lists or a resizing array, develop a weighted quick-union implementation that removes the restriction on needing the number of objects ahead of time. Add a method `newSite()` to the API, which returns an `int` identifier.

```
private class Connection
{
    int p;
    int q;

    public Connection(int p, int q)
    { this.p = p; this.q = q; }
}
```

Record to encapsulate connections

EXPERIMENTS

1.5.21 *Erdős-Renyi model.* Use your client from EXERCISE 1.5.17 to test the hypothesis that the number of pairs generated to get one component is $\sim \frac{1}{2}N \ln N$.

1.5.22 *Doubling test for Erdős-Renyi model.* Develop a performance-testing client that takes an `int` value `T` from the command line and performs `T` trials of the following experiment: Use your client from EXERCISE 1.5.17 to generate random connections, using `UnionFind` to determine connectivity as in our development client, looping until all sites are connected. For each `N`, print the value of `N`, the average number of connections processed, and the ratio of the running time to the previous. Use your program to validate the hypotheses in the text that the running times for quick-find and quick-union are quadratic and weighted quick-union is near-linear.

1.5.23 *Compare quick-find with quick-union for Erdős-Renyi model.* Develop a performance-testing client that takes an `int` value `T` from the command line and performs `T` trials of the following experiment: Use your client from EXERCISE 1.5.17 to generate random connections. Save the connections, so that you can use both quick-union and quick-find to determine connectivity as in our development client, looping until all sites are connected. For each `N`, print the value of `N` and the ratio of the two running times.

1.5.24 *Fast algorithms for Erdős-Renyi model.* Add weighted quick-union and weighted quick-union with path compression to your tests from EXERCISE 1.5.23. Can you discern a difference between these two algorithms?

1.5.25 *Doubling test for random grids.* Develop a performance-testing client that takes an `int` value `T` from the command line and performs `T` trials of the following experiment: Use your client from EXERCISE 1.5.18 to generate the connections in an `N`-by-`N` square grid, randomly oriented and in random order, then use `UnionFind` to determine connectivity as in our development client, looping until all sites are connected. For each `N`, print the value of `N`, the average number of connections processed, and the ratio of the running time to the previous. Use your program to validate the hypotheses in the text that the running times for quick-find and quick-union are quadratic and weighted quick-union is near-linear. *Note:* As `N` doubles, the number of sites in the grid increases by a factor of 4, so expect a doubling factor of 16 for quadratic and 4 for linear.

EXPERIMENTS *(continued)*

1.5.26 *Amortized plot for Erdős-Renyi.* Develop a client that takes an `int` value `N` from the command line and does an amortized plot of the cost of all operations in the style of the plots in the text for the process of generating random pairs of integers between 0 and `N-1`, calling `connected()` to determine if they are connected and then `union()` if not (as in our development client), looping until all sites are connected.

This page intentionally left blank



TWO

Sorting

2.1	Elementary Sorts.	244
2.2	Mergesort	270
2.3	Quicksort	288
2.4	Priority Queues.	308
2.5	Applications.	336

Sorting is the process of rearranging a sequence of objects so as to put them in some logical order. For example, your credit card bill presents transactions in order by date—they were likely put into that order by a sorting algorithm. In the early days of computing, the common wisdom was that up to 30 percent of all computing cycles was spent sorting. If that fraction is lower today, one likely reason is that sorting algorithms are relatively efficient, not that sorting has diminished in relative importance. Indeed, the ubiquity of computer usage has put us awash in data, and the first step to organizing data is often to sort it. All computer systems have implementations of sorting algorithms, for use by the system and by users.

There are three practical reasons for you to study sorting algorithms, even though you might just use a system sort:

- Analyzing sorting algorithms is a thorough introduction to the approach that we use to compare algorithm performance throughout the book.
- Similar techniques are effective in addressing other problems.
- We often use sorting algorithms as a starting point to solve other problems.

More important than these practical reasons is that the algorithms are elegant, classic, and effective.

Sorting plays a major role in commercial data processing and in modern scientific computing. Applications abound in transaction processing, combinatorial optimization, astrophysics, molecular dynamics, linguistics, genomics, weather prediction, and many other fields. Indeed, a sorting algorithm (quicksort, in SECTION 2.3) was named as one of the top ten algorithms for science and engineering of the 20th century.

In this chapter, we consider several classical sorting methods and an efficient implementation of a fundamental data type known as the priority queue. We discuss the theoretical basis for comparing sorting algorithms and conclude the chapter with a survey of applications of sorting and priority queues.



2.1 ELEMENTARY SORTS

FOR OUR FIRST EXCURSION into the area of sorting algorithms, we shall study two elementary sorting methods and a variation of one of them. Among the reasons for studying these relatively simple algorithms in detail are the following: First, they provide context in which we can learn terminology and basic mechanisms. Second, these simple algorithms are more effective in some applications than the sophisticated algorithms that we shall discuss later. Third, they are useful in improving the efficiency of more sophisticated algorithms, as we will see.

Rules of the game Our primary concern is algorithms for rearranging *arrays of items* where each item contains a *key*. The objective of the sorting algorithm is to rearrange the items such that their keys are ordered according to some well-defined ordering rule (usually numerical or alphabetical order). We want to rearrange the array so that each entry's key is no smaller than the key in each entry with a lower index and no larger than the key in each entry with a larger index. Specific characteristics of the keys and the items can vary widely across applications. In Java, items are just objects, and the abstract notion of a key is captured in a built-in mechanism—the `Comparable` interface—that is described on page 247.

The class `Example` on the facing page illustrates the conventions that we shall use: we put our sort code in a `sort()` method within a single class along with private helper functions `less()` and `exch()` (and perhaps some others) and a sample client `main()`. `Example` also illustrates code that might be useful for initial debugging: its test client `main()` sorts strings from standard input using the private method `show()` to print the contents of the array. Later in this chapter, we will examine various test clients for comparing algorithms and for studying their performance. To differentiate sorting methods, we give our various sort classes different names. Clients can call different implementations by name: `Insertion.sort()`, `Merge.sort()`, `Quick.sort()`, and so forth.

With but a few exceptions, our sort code refers to the data only through two operations: the method `less()` that compares items and the method `exch()` that exchanges them. The `exch()` method is easy to implement, and the `Comparable` interface makes it easy to implement `less()`. Restricting data access to these two operations makes our code readable and portable, and makes it easier for us to certify that algorithms are correct, to study performance and to compare algorithms. Before proceeding to consider sort implementations, we discuss a number of important issues that need to be carefully considered for every sort.

Template for sort classes

```
public class Example
{
    public static void sort(Comparable[] a)
    { /* See Algorithms 2.1, 2.2, 2.3, 2.4, 2.5, or 2.7. */ }

    private static boolean less(Comparable v, Comparable w)
    { return v.compareTo(w) < 0; }

    private static void exch(Comparable[] a, int i, int j)
    { Comparable t = a[i]; a[i] = a[j]; a[j] = t; }

    private static void show(Comparable[] a)
    { // Print the array, on a single line.
      for (int i = 0; i < a.length; i++)
        StdOut.print(a[i] + " ");
      StdOut.println();
    }

    public static boolean isSorted(Comparable[] a)
    { // Test whether the array entries are in order.
      for (int i = 1; i < a.length; i++)
        if (less(a[i], a[i-1])) return false;
      return true;
    }

    public static void main(String[] args)
    { // Read strings from standard input, sort them, and print.
      String[] a = In.readStrings();
      sort(a);
      assert isSorted(a);
      show(a);
    }
}
```

This class illustrates our conventions for implementing array sorts. For each sorting algorithm that we consider, we present a `sort()` method for a class like this with `Example` changed to a name that corresponds to the algorithm. The test client sorts strings taken from standard input, but, with this code, our sort methods are effective for any type of data that implements `Comparable`.

```
% more tiny.txt
S O R T E X A M P L E
```

```
% java Example < tiny.txt
A E E L M O P R S T X
```

```
% more words3.txt
bed bug dad yes zoo ... all bad yet
```

```
% java Example < words.txt
all bad bed bug dad ... yes yet zoo
```

Certification. Does the sort implementation always put the array in order, no matter what the initial order? As a conservative practice, we include the statement `assert isSorted(a);` in our test client to certify that array entries are in order after the sort. It is reasonable to include this statement in *every* sort implementation, even though we normally test our code and develop mathematical arguments that our algorithms are correct. Note that this test is sufficient only if we use `exch()` exclusively to change array entries. When we use code that stores values into the array directly, we do not have full assurance (for example, code that destroys the original input array by setting all values to be the same would pass this test).

Sorting cost model.

When studying sorting algorithms, we count *compares* and *exchanges*. For algorithms that do not use exchanges, we count *array accesses*.

Running time. We also test algorithm *performance*. We start by proving facts about the number of basic operations (compares and exchanges, or perhaps the number of times the array is accessed, for read or write) that the various sorting algorithms perform for various natural input models. Then we use these facts to develop hypotheses about the comparative performance of the algorithms and present tools that you can use to experimentally check the validity of such hypotheses. We use a consistent coding style to facilitate the development of valid hypotheses about performance that will hold true for typical implementations.

Extra memory. The amount of extra memory used by a sorting algorithm is often as important a factor as running time. The sorting algorithms divide into two basic types: those that sort *in place* and use no extra memory except perhaps for a small function-call stack or a constant number of instance variables, and those that need enough extra memory to hold another copy of the array to be sorted.

Types of data. Our sort code is effective for any item type that implements the `Comparable` interface. Adhering to Java's convention in this way is convenient because many of the types of data that you might want to sort implement `Comparable`. For example, Java's numeric wrapper types such as `Integer` and `Double` implement `Comparable`, as do `String` and various advanced types such as `File` or `URL`. Thus, you can just call one of our sort methods with an array of any of these types as argument. For example, the code at right uses `quicksort` (see SECTION 2.3) to sort `N` random `Double` values. When we create types of our own, we can enable client code to sort that type of data by implementing the `Comparable` interface. To do so, we just need to implement a `compareTo()` method that defines an ordering on objects of that type known as the *natural*

```
Double a[] = new Double[N];
for (int i = 0; i < N; i++)
    a[i] = StdRandom.uniform();
Quick.sort(a);
```

Sorting an array of random values

order for that type, as shown here for our `Date` data type (see page 91). Java's convention is that the call `v.compareTo(w)` returns an integer that is negative, zero, or positive (usually `-1`, `0`, or `+1`) when $v < w$, $v = w$, or $v > w$, respectively. For economy, we use standard notation like $v > w$ as shorthand for code like `v.compareTo(w) > 0` for the remainder of this paragraph. By convention, `v.compareTo(w)` throws an exception if `v` and `w` are incompatible types or either is `null`. Furthermore, `compareTo()` must implement a *total order*: it must be

- *Reflexive* (for all v , $v = v$)
- *Antisymmetric* (for all v and w , if $v < w$ then $w > v$ and if $v = w$ then $w = v$)
- *Transitive* (for all v , w , and x , if $v <= w$ and $w <= x$ then $v <= x$)

These rules are intuitive and standard in mathematics—you will have little difficulty adhering to them. In short, `compareTo()` implements our *key* abstraction—it defines the ordering of the items (objects) to be sorted, which can be any type of data that implements `Comparable`. Note that `compareTo()` need not use all of the instance variables. Indeed, the key might be a small part of each item.

```
public class Date implements Comparable<Date>
{
    private final int day;
    private final int month;
    private final int year;

    public Date(int d, int m, int y)
    { day = d; month = m; year = y; }

    public int day()    { return day;    }
    public int month() { return month; }
    public int year()  { return year;  }

    public int compareTo(Date that)
    {
        if (this.year > that.year ) return +1;
        if (this.year < that.year ) return -1;
        if (this.month > that.month) return +1;
        if (this.month < that.month) return -1;
        if (this.day   > that.day   ) return +1;
        if (this.day   < that.day   ) return -1;
        return 0;
    }

    public String toString()
    { return month + "/" + day + "/" + year; }
}
```

Defining a comparable type

FOR THE REMAINDER OF THIS CHAPTER, we shall address numerous algorithms for sorting arrays of objects having a natural order. To compare and contrast the algorithms, we shall examine a number of their properties, including the number of compares and exchanges that they use for various types of inputs and the amount of extra memory that they use. These properties lead to the development of hypotheses about performance properties, many of which have been validated on countless computers over the past several decades. Specific implementations always need to be checked, so we also consider tools for doing so. After considering the classic selection sort, insertion sort, shellsort, mergesort, quicksort, and heapsort algorithms, we will consider practical issues and applications, in SECTION 2.5.

Selection sort One of the simplest sorting algorithms works as follows: First, find the smallest item in the array and exchange it with the first entry (itself if the first entry is already the smallest). Then, find the next smallest item and exchange it with the second entry. Continue in this way until the entire array is sorted. This method is called *selection sort* because it works by repeatedly selecting the smallest remaining item.

As you can see from the implementation in ALGORITHM 2.1, the inner loop of selection sort is just a compare to test a current item against the smallest item found so far (plus the code necessary to increment the current index and to check that it does not exceed the array bounds); it could hardly be simpler. The work of moving the items around falls outside the inner loop: each exchange puts an item into its final position, so the number of exchanges is N . Thus, the running time is dominated by the number of compares.

Proposition A. Selection sort uses $\sim N^2/2$ compares and N exchanges to sort an array of length N .

Proof: You can prove this fact by examining the trace, which is an N -by- N table in which unshaded letters correspond to compares. About one-half of the entries in the table are unshaded—those on and above the diagonal. The entries on the diagonal each correspond to an exchange. More precisely, examination of the code reveals that, for each i from 0 to $N - 1$, there is one exchange and $N - 1 - i$ compares, so the totals are N exchanges and $(N - 1) + (N - 2) + \dots + 2 + 1 + 0 = N(N - 1) / 2 \sim N^2 / 2$ compares.

IN SUMMARY, selection sort is a simple sorting method that is easy to understand and to implement and is characterized by the following two signature properties:

Running time is insensitive to input. The process of finding the smallest item on one pass through the array does not give much information about where the smallest item might be on the next pass. This property can be disadvantageous in some situations. For example, the person using the sort client might be surprised to realize that it takes about as long to run selection sort for an array that is already in order or for an array with all keys equal as it does for a randomly-ordered array! As we shall see, other algorithms are better able to take advantage of initial order in the input.

Data movement is minimal. Each of the N exchanges changes the value of two array entries, so selection sort uses N exchanges—the number of array accesses is a *linear* function of the array size. None of the other sorting algorithms that we consider have this property (most involve linearithmic or quadratic growth).

ALGORITHM 2.1 Selection sort

```

public class Selection
{
    public static void sort(Comparable[] a)
    { // Sort a[] into increasing order.
        int N = a.length;           // array length
        for (int i = 0; i < N; i++)
        { // Exchange a[i] with smallest entry in a[i+1..N].
            int min = i;           // index of minimal entr.
            for (int j = i+1; j < N; j++)
                if (less(a[j], a[min])) min = j;
            exch(a, i, min);
        }
    }
    // See page 245 for less(), exch(), isSorted(), and main().
}

```

For each i , this implementation puts the i th smallest item in $a[i]$. The entries to the left of position i are the i smallest items in the array and are not examined again.

	i	min	$a[]$										
			0	1	2	3	4	5	6	7	8	9	10
			S	O	R	T	E	X	A	M	P	L	E
0	6		S	O	R	T	E	X	A	M	P	L	E
1	4		A	O	R	T	E	X	S	M	P	L	E
2	10		A	E	R	T	O	X	S	M	P	L	E
3	9		A	E	E	T	O	X	S	M	P	L	R
4	7		A	E	E	L	O	X	S	M	P	T	R
5	7		A	E	E	L	M	X	S	O	P	T	R
6	8		A	E	E	L	M	O	S	X	P	T	R
7	10		A	E	E	L	M	O	P	X	S	T	R
8	8		A	E	E	L	M	O	P	R	S	T	X
9	9		A	E	E	L	M	O	P	R	S	T	X
10	10		A	E	E	L	M	O	P	R	S	T	X
			A	E	E	L	M	O	P	R	S	T	X

entries in black are examined to find the minimum

entries in red are a[min]

entries in gray are in final position

Trace of selection sort (array contents just after each exchange)

Insertion sort The algorithm that people often use to sort bridge hands is to consider the cards one at a time, inserting each into its proper place among those already considered (keeping them sorted). In a computer implementation, we need to make space to insert the current item by moving larger items one position to the right, before inserting the current item into the vacated position. ALGORITHM 2.2 is an implementation of this method, which is called *insertion sort*.

As in selection sort, the items to the left of the current index are in sorted order during the sort, but they are not in their final position, as they may have to be moved to make room for smaller items encountered later. The array is, however, fully sorted when the index reaches the right end.

Unlike that of selection sort, the running time of insertion sort depends on the initial order of the items in the input. For example, if the array is large and its entries are already in order (or nearly in order), then insertion sort is much, much faster than if the entries are randomly ordered or in reverse order.

Proposition B. Insertion sort uses $\sim N^2/4$ compares and $\sim N^2/4$ exchanges to sort a randomly ordered array of length N with distinct keys, on the average. The worst case is $\sim N^2/2$ compares and $\sim N^2/2$ exchanges and the best case is $N - 1$ compares and 0 exchanges.

Proof: Just as for PROPOSITION A, the number of compares and exchanges is easy to visualize in the N -by- N diagram that we use to illustrate the sort. We count entries below the diagonal—all of them, in the worst case, and none of them, in the best case. For randomly ordered arrays, we expect each item to go about halfway back, on the average, so we count one-half of the entries below the diagonal.

The number of compares is the number of exchanges plus an additional term equal to N minus the number of times the item inserted is the smallest so far. In the worst case (array in reverse order), this term is negligible in relation to the total; in the best case (array in order) it is equal to $N - 1$.

Insertion sort works well for certain types of nonrandom arrays that often arise in practice, even if they are huge. For example, as just mentioned, consider what happens when you use insertion sort on an array that is already sorted. Each item is immediately determined to be in its proper place in the array, and the total running time is linear. (The running time of selection sort is quadratic for such an array.) The same is true for arrays whose keys are all equal (hence the condition in PROPOSITION B that the keys must be distinct).

ALGORITHM 2.2 Insertion sort

```

public class Insertion
{
    public static void sort(Comparable[] a)
    { // Sort a[] into increasing order.
        int N = a.length;
        for (int i = 1; i < N; i++)
        { // Insert a[i] among a[i-1], a[i-2], a[i-3]... ..
            for (int j = i; j > 0 && less(a[j], a[j-1]); j--)
                exch(a, j, j-1);
        }
    }
    // See page 245 for less(), exch(), isSorted(), and main().
}

```

For each i from 0 to $N-1$, exchange $a[i]$ with the entries that are smaller in $a[0]$ through $a[i-1]$. As the index i travels from left to right, the entries to its left are in sorted order in the array, so the array is fully sorted when i reaches the right end.

		a[]										
i	j	0	1	2	3	4	5	6	7	8	9	10
		S	O	R	T	E	X	A	M	P	L	E
1	0	O	S	R	T	E	X	A	M	P	L	E
2	1	O	R	S	T	E	X	A	M	P	L	E
3	3	O	R	S	T	E	X	A	M	P	L	E
4	0	E	O	R	S	T	X	A	M	P	L	E
5	5	E	O	R	S	T	X	A	M	P	L	E
6	0	A	E	O	R	S	T	X	M	P	L	E
7	2	A	E	M	O	R	S	T	X	P	L	E
8	4	A	E	M	O	P	R	S	T	X	L	E
9	2	A	E	L	M	O	P	R	S	T	X	E
10	2	A	E	E	L	M	O	P	R	S	T	X
		A	E	E	L	M	O	P	R	S	T	X

entries in gray
do not move

entry in red
is a[j]

entries in black
moved one position
right for insertion

Trace of insertion sort (array contents just after each insertion)

More generally, we consider the concept of a *partially sorted* array, as follows: An *inversion* is a pair of entries that are out of order in the array. For instance, E X A M P L E has 11 inversions: E-A, X-A, X-M, X-P, X-L, X-E, M-L, M-E, P-L, P-E, and L-E. If the number of inversions in an array is less than a constant multiple of the array size, we say that the array is *partially sorted*. Typical examples of partially sorted arrays are the following:

- An array where each entry is not far from its final position
- A small array appended to a large sorted array
- An array with only a few entries that are not in place

Insertion sort is an efficient method for such arrays; selection sort is not. Indeed, when the number of inversions is low, insertion sort is likely to be faster than any sorting method that we consider in this chapter.

Proposition C. The number of exchanges used by insertion sort is equal to the number of inversions in the array, and the number of compares is at least equal to the number of inversions and at most equal to the number of inversions plus the array size minus 1.

Proof: Every exchange involves two inverted adjacent entries and thus reduces the number of inversions by one, and the array is sorted when the number of inversions reaches zero. Every exchange corresponds to a compare, and an additional compare might happen for each value of i from 1 to $N-1$ (when $a[i]$ does not reach the left end of the array).

It is not difficult to speed up insertion sort substantially, by shortening its inner loop to move the larger entries to the right one position rather than doing full exchanges (thus cutting the number of array accesses in half). We leave this improvement for an exercise (see EXERCISE 2.1.25).

IN SUMMARY, insertion sort is an excellent method for partially sorted arrays and is also a fine method for tiny arrays. These facts are important not just because such arrays frequently arise in practice, but also because both types of arrays arise in intermediate stages of advanced sorting algorithms, so we will be considering insertion sort again in relation to such algorithms.

Visualizing sorting algorithms Throughout this chapter, we will be using a simple visual representation to help describe the properties of sorting algorithms. Rather than tracing the progress of a sort with key values such as letters, numbers, or words, we use vertical bars, to be sorted by their heights. The advantage of such a representation is that it can give insights into the behavior of a sorting method.

For example, you can see at a glance on the visual traces at right that insertion sort does not touch entries to the right of the scan pointer and selection sort does not touch entries to the left of the scan pointer. Moreover, it is clear from the visual traces that, since insertion sort also does not touch entries smaller than the inserted item, it uses about half the number of compares as selection sort, on the average.

With our `StdDraw` library, developing a visual trace is not much more difficult than doing a standard trace. We sort `Double` values, instrument the algorithm to call `show()` as appropriate (just as we do for a standard trace), and develop a version of `show()` that uses `StdDraw` to draw the bars instead of printing the results. The most complicated task is setting the scale for the y -axis so that the lines of the trace appear in the expected order. You are encouraged to work EXERCISE 2.1.18 in order to gain a better appreciation of the value of visual traces and the ease of creating them.

An even simpler task is to *animate* the trace so that you can see the array dynamically evolve to the sorted result. Developing an animated trace involves essentially the same process described in the previous paragraph, but without having to worry about the y -axis (just clear the window and redraw the bars each time). Though we cannot make the case on the printed page, such animated representations are also effective in gaining insight into how an algorithm works. You are also encouraged to work EXERCISE 2.1.17 to see for yourself.

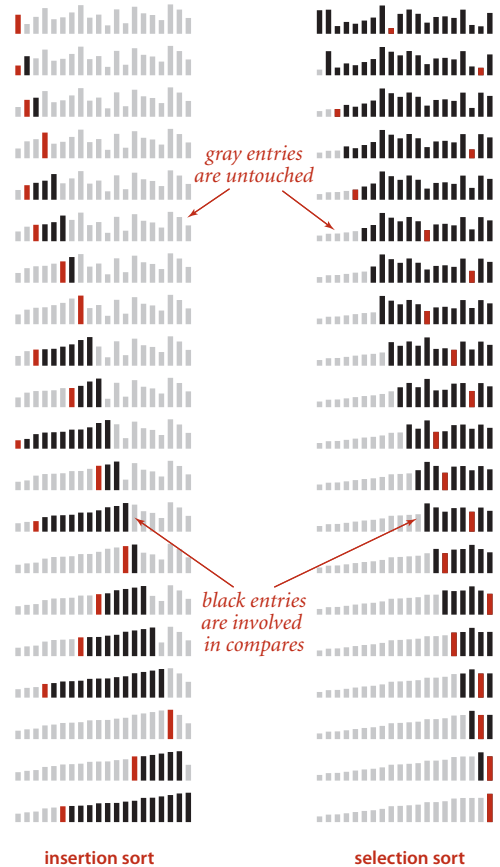

Visual traces of elementary sorting algorithms

Comparing two sorting algorithms Now that we have two implementations, we are naturally interested in knowing which one is faster: selection sort (ALGORITHM 2.1) or insertion sort (ALGORITHM 2.2). Questions like this arise again and again and again in the study of algorithms and are a major focus throughout this book. We have discussed some fundamental ideas in CHAPTER 1, but we use this first case in point to illustrate our basic approach to answering such questions. Generally, following the approach introduced in SECTION 1.4, we compare algorithms by

- Implementing and debugging them
- Analyzing their basic properties
- Formulating a hypothesis about comparative performance
- Running experiments to validate the hypothesis

These steps are nothing more than the time-honored *scientific method*, applied to the study of algorithms.

In the present context, ALGORITHM 2.1 and ALGORITHM 2.2 are evidence of the first step; PROPOSITIONS A, B, and C constitute the second step; PROPERTY D on page 255 constitutes the third step; and the class `SortCompare` on page 256 enables the fourth step. These activities are all interrelated.

Our brief descriptions mask a substantial amount of effort that is required to properly implement, analyze, and test algorithms. Every programmer knows that such code is the product of a long round of debugging and refinement, every mathematician knows that proper analysis can be very difficult, and every scientist knows that formulating hypotheses and designing and executing experiments to validate them require great care. Full development of such results is reserved for experts studying our most important algorithms, but every programmer using an algorithm should be aware of the scientific context underlying its performance properties.

Having developed implementations, our next choice is to settle on an appropriate model for the input. For sorting, a natural model, which we have used for PROPOSITIONS A, B, and C, is to assume that the arrays are randomly ordered *and* that the key values are distinct. In applications where significant numbers of equal key values are present we will need a more complicated model.

How do we formulate a hypothesis about the running times of insertion sort and selection sort for randomly ordered arrays? Examining ALGORITHMS 2.1 and 2.2 and PROPOSITIONS A and B, it follows immediately that the running time of both algorithms should be quadratic for randomly ordered arrays. That is, the running time of insertion sort for such an input is proportional to some small constant times N^2 and the running time of selection sort is proportional to some other small constant times N^2 . The values of the two constants depend on the cost of compares and exchanges on the particular computer being used. For many types of data and for typical computers, it is reasonable

to assume that these costs are similar (though we will see a few significant exceptions). The following hypothesis follows directly:

Property D. The running times of insertion sort and selection sort are quadratic and within a small constant factor of one another for randomly ordered arrays of distinct values.

Evidence: This statement has been validated on many different computers over the past half-century. Insertion sort was about twice as fast as selection sort when the first edition of this book was written in 1980 and it still is today, even though it took several hours to sort 100,000 items with these algorithms then and just several seconds today. Is insertion sort a bit faster than selection sort on your computer? To find out, you can use the class `SortCompare` on the next page, which uses the `sort()` methods in the classes named as command-line arguments to perform the given number of experiments (sorting arrays of the given size) and prints the ratio of the observed running times of the algorithms.

To validate this hypothesis, we use `SortCompare` (see page 256) to perform the experiments. As usual, we use `Stopwatch` to compute the running time. The implementation of `time()` shown here does the job for the basic sorts in this chapter. The “randomly ordered” input model is embedded in the `timeRandomInput()` method in `SortCompare`, which generates random `Double` values, sorts them, and returns the total measured time of the sort for the given number of trials. Using random `Double` values between 0.0 and 1.0 is much simpler than the alternative of using a library function such as `StdRandom.shuffle()` and is effective because equal key values are very unlikely (see EXERCISE 2.5.31). As discussed in CHAPTER 1, the number of trials is taken as an argument both to take advantage of the law of large numbers (the more trials, the total running time divided by the number of trials is a more accurate estimate of the true average running time) and to help damp out system effects. You are encouraged to experiment with `SortCompare`

```
public static double time(String alg, Comparable[] a)
{
    Stopwatch timer = new Stopwatch();
    if (alg.equals("Insertion")) Insertion.sort(a);
    if (alg.equals("Selection")) Selection.sort(a);
    if (alg.equals("Shell")) Shell.sort(a);
    if (alg.equals("Merge")) Merge.sort(a);
    if (alg.equals("Quick")) Quick.sort(a);
    if (alg.equals("Heap")) Heap.sort(a);
    return timer.elapsedTime();
}
```

Timing one of the sort algorithms in this chapter on a given input

Comparing two sorting algorithms

```
public class SortCompare
{
    public static double time(String alg, Double[] a)
    { /* See text. */ }

    public static double timeRandomInput(String alg, int N, int T)
    { // Use alg to sort T random arrays of length N.
        double total = 0.0;
        Double[] a = new Double[N];
        for (int t = 0; t < T; t++)
        { // Perform one experiment (generate and sort an array).
            for (int i = 0; i < N; i++)
                a[i] = StdRandom.uniform();
            total += time(alg, a);
        }
        return total;
    }

    public static void main(String[] args)
    {
        String alg1 = args[0];
        String alg2 = args[1];
        int N = Integer.parseInt(args[2]);
        int T = Integer.parseInt(args[3]);
        double t1 = timeRandomInput(alg1, N, T); // total for alg1
        double t2 = timeRandomInput(alg2, N, T); // total for alg2
        StdOut.printf("For %d random Doubles\n    %s is", N, alg1);
        StdOut.printf(" %.1f times faster than %s\n", t2/t1, alg2);
    }
}
```

This client runs the two sorts named in the first two command-line arguments on arrays of N (the third command-line argument) random `Double` values between 0.0 and 1.0, repeating the experiment T (the fourth command-line argument) times, then prints the ratio of the total running times.

```
% java SortCompare Insertion Selection 1000 100
For 1000 random Doubles
Insertion is 1.7 times faster than Selection
```

on your computer to learn the extent to which its conclusion about insertion sort and selection sort is robust.

PROPERTY D is intentionally a bit vague—the value of the small constant factor is left unstated and the assumption that the costs of compares and exchanges are similar is left unstated—so that it can apply in a broad variety of situations. When possible, we try to capture essential aspects of the performance of each of the algorithms that we study in statements like this. As discussed in CHAPTER 1, each *Property* that we consider needs to be tested scientifically in a given situation, perhaps supplemented with a more refined hypothesis based upon a related *Proposition* (mathematical truth).

For practical applications, there is one further step, which is crucial: *run experiments to validate the hypothesis on the data at hand*. We defer consideration of this step to SECTION 2.5 and the exercises. In this case, if your sort keys are not distinct and/or not randomly ordered, PROPERTY D might not hold. You can randomly order an array with `StdRandom.shuffle()`, but applications with significant numbers of equal keys involve more careful analysis.

Our discussions of the analyses of algorithms are intended to be starting points, not final conclusions. If some other question about performance of the algorithms comes to mind, you can study it with a tool like `SortCompare`. Many opportunities to do so are presented in the exercises.

WE DO NOT DWELL further on the comparative performance of insertion sort and selection sort because we are much more interested in algorithms that can run a hundred or a thousand or a million times faster than either. Still, understanding these elementary algorithms is worthwhile for several reasons:

- They help us work out the ground rules.
- They provide performance benchmarks.
- They often are the method of choice in some specialized situations.
- They can serve as the basis for developing better algorithms.

For these reasons, we will use the same basic approach and consider elementary algorithms for every problem that we study throughout this book, not just sorting. Programs like `SortCompare` play a critical role in this incremental approach to algorithm development. At every step along the way, we can use such a program to help evaluate whether a new algorithm or an improved version of a known algorithm provides the performance gains that we expect.

Shellsort To exhibit the value of knowing properties of elementary sorts, we next consider a fast algorithm based on insertion sort. Insertion sort is slow for large unsorted arrays because the only exchanges it does involve adjacent entries, so items can move through the array only one place at a time. For example, if the item with the smallest key happens to be at the end of the array, $N-1$ exchanges are needed to get that one item where it belongs. *Shellsort* is a simple extension of insertion sort that gains speed by allowing exchanges of array entries that are far apart, to produce partially sorted arrays that can be efficiently sorted, eventually by insertion sort.

The idea is to rearrange the array to give it the property that taking every h th entry (starting anywhere) yields a sorted subsequence. Such an array is said to be h -sorted. Put

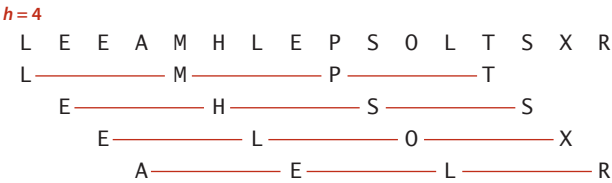

An h -sorted sequence is h interleaved sorted subsequences

another way, an h -sorted array is h independent sorted subsequences, interleaved together. By h -sorting for some large values of h , we can move items in the array long distances and thus make it easier to h -sort for smaller values of h . Using such a procedure for any sequence of values of h that ends in 1 will produce a sorted array: that is shellsort. The implementation

in ALGORITHM 2.3 on the facing page uses the sequence of decreasing values $\frac{1}{2}(3^k-1)$, starting at the largest increment less than $N/3$ and decreasing to 1. We refer to such a sequence as an *increment sequence*. ALGORITHM 2.3 computes its increment sequence; another alternative is to store an increment sequence in an array.

One way to implement shellsort would be, for each h , to use insertion sort independently on each of the h subsequences. Because the subsequences are independent, we can use an even simpler approach: when h -sorting the array, we insert each item among the previous items in its h -subsequence by exchanging it with those that have larger keys (moving them each one position to the right in the subsequence). We accomplish this task by using the insertion-sort code, but modified to decrement by h instead of 1 when moving through the array. This observation reduces the shellsort implementation to an insertion-sort-like pass through the array for each increment.

Shellsort gains efficiency by making a tradeoff between size and partial order in the subsequences. At the beginning, the subsequences are short; later in the sort, the subsequences are partially sorted. In both cases, insertion sort is the method of choice. The extent to which the subsequences are partially sorted is a variable factor that depends strongly on the increment sequence. Understanding shellsort's performance is a challenge. Indeed, ALGORITHM 2.3 is the only sorting method we consider whose performance on randomly ordered arrays has not been precisely characterized.

ALGORITHM 2.3 Shellsort

```

public class Shell
{
    public static void sort(Comparable[] a)
    { // Sort a[] into increasing order.
        int N = a.length;
        int h = 1;
        while (h < N/3) h = 3*h + 1; // 1, 4, 13, 40, 121, 364, 1093, ...
        while (h >= 1)
        { // h-sort the array.
            for (int i = h; i < N; i++)
            { // Insert a[i] among a[i-h], a[i-2*h], a[i-3*h]... .
                for (int j = i; j >= h && less(a[j], a[j-h]); j -= h)
                    exch(a, j, j-h);
            }
            h = h/3;
        }
    }
}

// See page 245 for less(), exch(), isSorted(), and main().
}

```

If we modify insertion sort (ALGORITHM 2.2) to h-sort the array and add an outer loop to decrease h through a sequence of increments starting at an increment as large as a constant fraction of the array length and ending at 1, we are led to this compact shellsort implementation.

```

% java SortCompare Shell Insertion 100000 100
For 100000 random Doubles
Shell is 600 times faster than Insertion

```

```

input  S H E L L S O R T E X A M P L E
13-sort P H E L L S O R T E X A M S L E
4-sort  L E E A M H L E P S O L T S X R
1-sort  A E E E H L L L M O P R S S T X

```

Shellsort trace (array contents after each pass)

How do we decide what increment sequence to use? In general, this question is a difficult one to answer. The performance of the algorithm depends not just on the number of increments, but also on arithmetical interactions among the increments such as

input	S H E L L S O R T E X A M P L E
13-sort	P H E L L S O R T E X A M S L E P H E L L S O R T E X A M S L E P H E L L S O R T E X A M S L E
4-sort	L H E L P S O R T E X A M S L E L H E L P S O R T E X A M S L E L H E L P S O R T E X A M S L E L H E L P S O R T E X A M S L E L H E L P S O R T E X A M S L E L E E L P H O R T S X A M S L E L E E A P H O L T S X R M S L E L E E A M H O L P S X R T S L E L E E A M H L L P S O R T S X E L E E A M H L E P S O L T S X R
1-sort	E L E A M H L E P S O L T S X R E E L A M H L E P S O L T S X R A E E L M H L E P S O L T S X R A E E L M H L E P S O L T S X R A E E H L M L E P S O L T S X R A E E H L L M P S O L T S X R A E E E H L L M P S O L T S X R A E E E H L L M P S O L T S X R A E E E H L L M O P S L T S X R A E E E H L L L M O P S T S X R A E E E H L L L M O P S T S X R A E E E H L L L M O P S S T X R A E E E H L L L M O P R S S T X
result	A E E E H L L L M O P R S S T X

Detailed trace of shellsort (insertions)

the size of their common divisors and other properties. Many different increment sequences have been studied in the literature, but no provably best sequence has been found. The increment sequence that is used in ALGORITHM 2.3 is easy to compute and use, and performs nearly as well as more sophisticated increment sequences that have been discovered that have provably better worst-case performance. Increment sequences that are substantially better still may be waiting to be discovered.

Shellsort is useful even for large arrays, particularly by contrast with selection sort and insertion sort. It also performs well on arrays that are in arbitrary order (not necessarily random). Indeed, constructing an array for which shellsort runs slowly for a particular increment sequence is usually a challenging exercise.

As you can learn with SortCompare, shellsort is much faster than insertion sort and selection sort, and its speed advantage increases with the array

size. Before reading further, try using SortCompare to compare shellsort with insertion sort and selection sort for array sizes that are increasing powers of 2 on your computer (see EXERCISE 2.1.27). You will see that shellsort makes it possible to address sorting

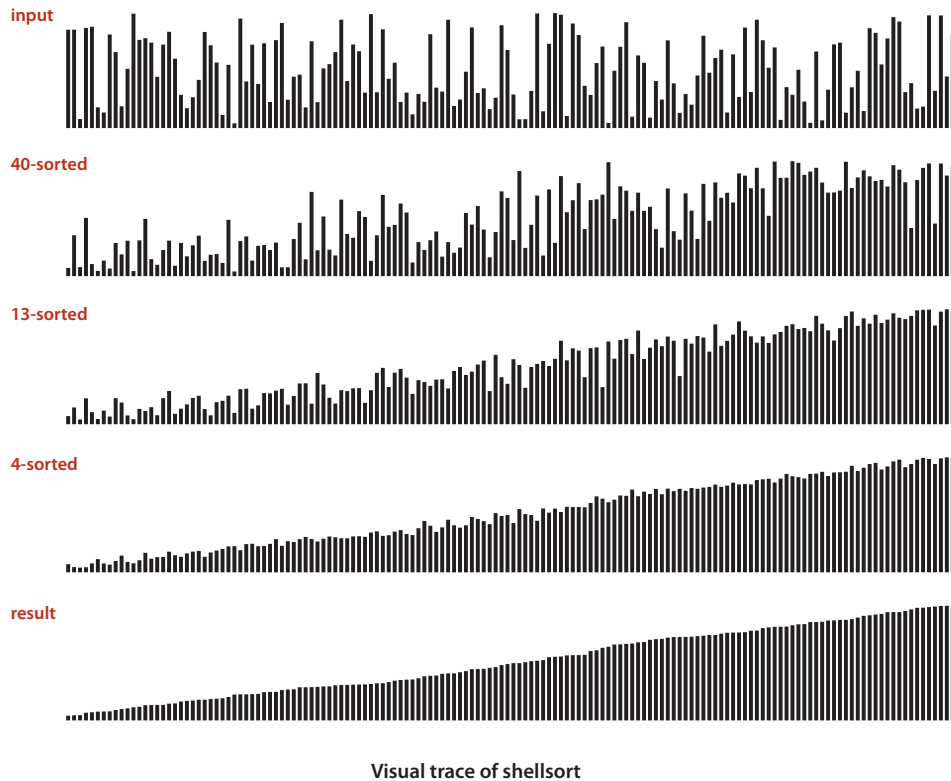

Visual trace of shellsort

problems that could not be addressed with the more elementary algorithms. This example is our first practical illustration of an important principle that pervades this book: *achieving speedups that enable the solution of problems that could not otherwise be solved is one of the prime reasons to study algorithm performance and design.*

The study of the performance characteristics of shellsort requires mathematical arguments that are beyond the scope of this book. If you want to be convinced, start by thinking about how you would prove the following fact: *when an h -sorted array is k -sorted, it remains h -sorted.* As for the performance of ALGORITHM 2.3, the most important result in the present context is the knowledge that *the running time of shellsort is not necessarily quadratic*—for example, it is known that the worst-case number of compares for ALGORITHM 2.3 is proportional to $N^{3/2}$. That such a simple modification

can break the quadratic-running-time barrier is quite interesting, as doing so is a prime goal for many algorithm design problems.

No mathematical results are available about the average-case number of compares for shellsort for randomly ordered input. Increment sequences have been devised that drive the asymptotic growth of the worst-case number of compares down to $N^{4/3}$, $N^{5/4}$, $N^{6/5}$, . . . , but many of these results are primarily of academic interest because these functions are hard to distinguish from one another (and from a constant factor of N) for practical values of N .

In practice, you can safely take advantage of the past scientific study of shellsort just by using the increment sequence in ALGORITHM 2.3 (or one of the increment sequences in the exercises at the end of this section, which may improve performance by 20 to 40 percent). Moreover, you can easily validate the following hypothesis:

Property E. The number of compares used by shellsort with the increments 1, 4, 13, 40, 121, 364, . . . is bounded by a small multiple of N times the number of increments used.

Evidence: Instrumenting ALGORITHM 2.3 to count compares and divide by the number of increments used is a straightforward exercise (see EXERCISE 2.1.12). Extensive experiments suggest that the average number of compares per increment might be $N^{1/5}$, but it is quite difficult to discern the growth in that function unless N is huge. This property also seems to be rather insensitive to the input model.

EXPERIENCED PROGRAMMERS sometimes choose shellsort because it has acceptable running time even for moderately large arrays; it requires a small amount of code; and it uses no extra space. In the next few sections, we shall see methods that are more efficient, but they are perhaps only twice as fast (if that much) except for very large N , and they are more complicated. If you need a solution to a sorting problem, and are working in a situation where a system sort may not be available (for example, code destined for hardware or an embedded system), you can safely use shellsort, then determine sometime later whether it will be worthwhile to replace it with a more sophisticated method.

Q&A

Q. Sorting seems like a toy problem. Aren't many of the other things that we do with computers much more interesting?

A. Perhaps, but many of those interesting things are *made possible* by fast sorting algorithms. You will find many examples in SECTION 2.5 and throughout the rest of the book. Sorting is worth studying now because the problem is easy to understand, and you can appreciate the ingenuity behind the faster algorithms.

Q. Why so many sorting algorithms?

A. One reason is that the performance of many algorithms depends on the input values, so different algorithms might be appropriate for different applications having different kinds of input. For example, insertion sort is the method of choice for partially sorted or tiny arrays. Other constraints, such as space and treatment of equal keys, also come into play. We will revisit this question in SECTION 2.5.

Q. Why bother using the tiny helper methods `less()` and `exch()`?

A. They are basic abstract operations needed by any sort algorithm, and the code is easier to understand in terms of these abstractions. Moreover, they make the code directly portable to other settings. For example, much of the code in ALGORITHMS 2.1 and 2.2 is legal code in several other programming languages. Even in Java, we can use this code as the basis for sorting primitive types (which are not `Comparable`): simply implement `less()` with the code `v < w`.

Q. When I run `SortCompare`, I get different values each time that I run it (and those are different from the values in the book). Why?

A. For starters, you have a different computer from the one we used, not to mention a different operating system, Java runtime, and so forth. All of these differences might lead to slight differences in the machine code for the algorithms. Differences each time that you run it on your computer might be due to other applications that you are running or various other conditions. Running a very large number of trials should dampen the effect. The lesson is that small differences in algorithm performance are difficult to notice nowadays. That is a primary reason that we focus on large ones!

EXERCISES

- 2.1.1** Show, in the style of the example trace with ALGORITHM 2.1, how selection sort sorts the array E A S Y Q U E S T I O N.
- 2.1.2** What is the maximum number of exchanges involving any particular element during selection sort? What is the average number of exchanges involving an element?
- 2.1.3** Give an example of an array of N items that maximizes the number of times the test $a[j] < a[\text{min}]$ fails (and, therefore, min gets updated) during the operation of selection sort (ALGORITHM 2.1).
- 2.1.4** Show, in the style of the example trace with ALGORITHM 2.2, how insertion sort sorts the array E A S Y Q U E S T I O N.
- 2.1.5** For each of the two conditions in the inner for loop in insertion sort (ALGORITHM 2.2), describe an array of N items where that condition is always false when the loop terminates.
- 2.1.6** Which method runs faster for an array with all keys identical, selection sort or insertion sort?
- 2.1.7** Which method runs faster for an array in reverse order, selection sort or insertion sort?
- 2.1.8** Suppose that we use insertion sort on a randomly ordered array where elements have only one of three values. Is the running time linear, quadratic, or something in between?
- 2.1.9** Show, in the style of the example trace with ALGORITHM 2.3, how shellsort sorts the array E A S Y S H E L L S O R T Q U E S T I O N.
- 2.1.10** Why not use selection sort for h -sorting in shellsort?
- 2.1.11** Implement a version of shellsort that keeps the increment sequence in an array, rather than computing it.
- 2.1.12** Instrument shellsort to print the number of compares divided by the array size for each increment. Write a test client that tests the hypothesis that this number is a small constant, by sorting arrays of random Double values, using array sizes that are increasing powers of 10, starting at 100.

CREATIVE PROBLEMS

2.1.13 *Deck sort.* Explain how you would put a deck of cards in order by suit (in the order spades, hearts, clubs, diamonds) and by rank within each suit, with the restriction that the cards must be laid out face down in a row, and the only allowed operations are to check the values of two cards and to exchange two cards (keeping them face down).

2.1.14 *Deque sort.* Explain how you would sort a deck of cards, with the restriction that the only allowed operations are to look at the values of the top two cards, to exchange the top two cards, and to move the top card to the bottom of the deck.

2.1.15 *Expensive exchange.* A clerk at a shipping company is charged with the task of rearranging a number of large crates in order of the time they are to be shipped out. Thus, the cost of compares is very low (just look at the labels) relative to the cost of exchanges (move the crates). The warehouse is nearly full—there is extra space sufficient to hold any one of the crates, but not two. What sorting method should the clerk use?

2.1.16 *Certification.* Write a `check()` method that calls `sort()` for a given array and returns `true` if `sort()` puts the array in order *and* leaves the same set of objects in the array as were there initially, `false` otherwise. Do not assume that `sort()` is restricted to move data only with `exch()`. You may use `Arrays.sort()` and assume that it is correct.

2.1.17 *Animation.* Add code to `Insertion` and `Selection` to make them draw the array contents as vertical bars like the visual traces in this section, redrawing the bars after each pass, to produce an animated effect, ending in a “sorted” picture where the bars appear in order of their height. *Hint:* Use a client like the one in the text that generates random `Double` values, insert calls to `show()` as appropriate in the sort code, and implement a `show()` method that clears the canvas and draws the bars.

2.1.18 *Visual trace.* Modify your solution to the previous exercise to make `Insertion` and `Selection` produce visual traces such as those depicted in this section. *Hint:* Judicious use of `setYscale()` makes this problem easy. *Extra credit:* Add the code necessary to produce red and gray color accents such as those in our figures.

2.1.19 *Shellsort worst case.* Construct an array of 100 elements containing the numbers 1 through 100 for which shellsort, with the increments 1 4 13 40, uses as large a number of compares as you can find.

2.1.20 *Shellsort best case.* What is the *best* case for shellsort? Justify your answer.

CREATIVE PROBLEMS *(continued)*

2.1.21 *Comparable transactions.* Using our code for `Date` (page 247) as a model, expand your implementation of `Transaction` (EXERCISE 1.2.13) so that it implements `Comparable`, such that transactions are kept in order by amount.

Solution:

```
public class Transaction implements Comparable<Transaction>
{
    ...
    private final double amount;
    ...
    public int compareTo(Transaction that)
    {
        if (this.amount > that.amount) return +1;
        if (this.amount < that.amount) return -1;
        return 0;
    }
    ...
}
```

2.1.22 *Transaction sort test client.* Write a class `SortTransactions` that consists of a static method `main()` that reads a sequence of transactions from standard input, sorts them, and prints the result on standard output (see EXERCISE 1.3.17).

Solution:

```
public class SortTransactions
{
    public static Transaction[] readTransactions()
    { // See Exercise 1.3.17 }

    public static void main(String[] args)
    {
        Transaction[] transactions = readTransactions();
        Shell.sort(transactions);
        for (Transaction t : transactions)
            StdOut.println(t);
    }
}
```

EXPERIMENTS

2.1.23 *Deck sort.* Ask a few friends to sort a deck of cards (see EXERCISE 2.1.13). Observe them carefully and write down the method(s) that they use.

2.1.24 *Insertion sort with sentinel.* Develop an implementation of insertion sort that eliminates the $j > 0$ test in the inner loop by first putting the smallest item into position. Use `SortCompare` to evaluate the effectiveness of doing so. *Note:* It is often possible to avoid an index-out-of-bounds test in this way—the element that enables the test to be eliminated is known as a *sentinel*.

2.1.25 *Insertion sort without exchanges.* Develop an implementation of insertion sort that moves larger elements to the right one position with one array access per entry, rather than using `exch()`. Use `SortCompare` to evaluate the effectiveness of doing so.

2.1.26 *Primitive types.* Develop a version of insertion sort that sorts arrays of `int` values and compare its performance with the implementation given in the text (which sorts `Integer` values and implicitly uses autoboxing and auto-unboxing to convert).

2.1.27 *Shellsort is subquadratic.* Use `SortCompare` to compare shellsort with insertion sort and selection sort on your computer. Use array sizes that are increasing powers of 2, starting at 128.

2.1.28 *Equal keys.* Formulate and validate hypotheses about the running time of insertion sort and selection sort for arrays that contain just two key values, assuming that the values are equally likely to occur.

2.1.29 *Shellsort increments.* Run experiments to compare the increment sequence in ALGORITHM 2.3 with the sequence 1, 5, 19, 41, 109, 209, 505, 929, 2161, 3905, 8929, 16001, 36289, 64769, 146305, 260609 (which is formed by merging together the sequences $9 \cdot 4^k - 9 \cdot 2^k + 1$ and $4^k - 3 \cdot 2^k + 1$). See EXERCISE 2.1.11.

2.1.30 *Geometric increments.* Run experiments to determine a value of t that leads to the lowest running time of shellsort for random arrays for the increment sequence 1, $\lfloor t \rfloor$, $\lfloor t^2 \rfloor$, $\lfloor t^3 \rfloor$, $\lfloor t^4 \rfloor$, ... for $N = 10^6$. Give the values of t and the increment sequences for the best three values that you find.

EXPERIMENTS *(continued)*

The following exercises describe various clients for helping to evaluate sorting methods. They are intended as starting points for helping to understand performance properties, using random data. In all of them, use `time()`, as in `SortCompare`, so that you can get more accurate results by specifying more trials in the second command-line argument. We refer back to these exercises in later sections when evaluating more sophisticated methods.

2.1.31 *Doubling test.* Write a client that performs a doubling test for sort algorithms. Start at `N` equal to 1000, and print `N`, the predicted number of seconds, the actual number of seconds, and the ratio as `N` doubles. Use your program to validate that insertion sort and selection sort are quadratic for random inputs, and formulate and test a hypothesis for shellsort.

2.1.32 *Plot running times.* Write a client that uses `StdDraw` to plot the average running times of the algorithm for random inputs and various values of the array size. You may add one or two more command-line arguments. Strive to design a useful tool.

2.1.33 *Distribution.* Write a client that enters into an infinite loop running `sort()` on arrays of the size given as the third command-line argument, measures the time taken for each run, and uses `StdDraw` to plot the average running times. A picture of the *distribution* of the running times should emerge.

2.1.34 *Corner cases.* Write a client that runs `sort()` on difficult or pathological cases that might turn up in practical applications. Examples include arrays that are already in order, arrays in reverse order, arrays where all keys are the same, arrays consisting of only two distinct values, and arrays of size 0 or 1.

2.1.35 *Nonuniform distributions.* Write a client that generates test data by randomly ordering objects using other distributions than uniform, including the following:

- Gaussian
- Poisson
- Geometric
- Discrete (see EXERCISE 2.1.28 for a special case)

Develop and test hypotheses about the effect of such input on the performance of the algorithms in this section.

2.1.36 *Nonuniform data.* Write a client that generates test *data* that is not uniform, including the following:

- Half the data is 0s, half 1s.
- Half the data is 0s, half the remainder is 1s, half the remainder is 2s, and so forth.
- Half the data is 0s, half random `int` values.

Develop and test hypotheses about the effect of such input on the performance of the algorithms in this section.

2.1.37 *Partially sorted.* Write a client that generates partially sorted arrays, including the following:

- 95 percent sorted, last percent random values
- All entries within 10 positions of their final place in the array
- Sorted except for 5 percent of the entries randomly dispersed throughout the array

Develop and test hypotheses about the effect of such input on the performance of the algorithms in this section.

2.1.38 *Various types of items.* Write a client that generates arrays of items of various types with random key values, including the following:

- `String` key (at least ten characters), one `double` value
- `double` key, ten `String` values (all at least ten characters)
- `int` key, one `int[20]` value

Develop and test hypotheses about the effect of such input on the performance of the algorithms in this section.

2.2 MERGESORT

THE ALGORITHMS that we consider in this section are based on a simple operation known as *merging*: combining two ordered arrays to make one larger ordered array. This operation immediately leads to a simple recursive sort method known as *mergesort*: to sort an array, divide it into two halves, sort the two halves (recursively), and then merge the results. As you will see, one of mergesort's most attractive properties is that it guarantees to sort any array of N items in time proportional to $N \log N$. Its prime disadvantage is that it uses extra space proportional to N .

input	M	E	R	G	E	S	O	R	T	E	X	A	M	P	L	E	
sort left half	E	E	G	M	O	R	R	S		T	E	X	A	M	P	L	E
sort right half	E	E	G	M	O	R	R	S		A	E	E	L	M	P	T	X
merge results	A	E	E	E	E	G	L	M	M	O	P	R	R	S	T	X	

Mergesort overview

Abstract in-place merge The straightforward approach to implementing merging is to design a method that merges two disjoint ordered arrays of Comparable objects into a third array. This strategy is easy to implement: create an output array of the requisite size and then choose successively the smallest remaining item from the two input arrays to be the next item added to the output array.

However, when we mergesort a large array, we are doing a huge number of merges, so the cost of creating a new array to hold the output every time that we do a merge is problematic. It would be much more desirable to have an in-place method so that we could sort the first half of the array in place, then sort the second half of the array in place, then do the merge of the two halves by moving the items around within the array, without using a significant amount of other extra space. It is worthwhile to pause momentarily to consider how you might do that. At first blush, this problem seems to be one that must be simple to solve, but solutions that are known are quite complicated, especially by comparison to alternatives that use extra space.

Still, the *abstraction* of an in-place merge is useful. Accordingly, we use the method signature `merge(a, lo, mid, hi)` to specify a merge method that puts the result of merging the subarrays `a[lo..mid]` with `a[mid+1..hi]` into a single ordered array, leaving the result in `a[lo..hi]`. The code on the next page implements this merge method in just a few lines by copying everything to an auxiliary array and then merging back to the original. Another approach is described in EXERCISE 2.2.10.

Abstract in-place merge

```

public static void merge(Comparable[] a, int lo, int mid, int hi)
{ // Merge a[lo..mid] with a[mid+1..hi].
  int i = lo, j = mid+1;

  for (int k = lo; k <= hi; k++) // Copy a[lo..hi] to aux[lo..hi].
    aux[k] = a[k];

  for (int k = lo; k <= hi; k++) // Merge back to a[lo..hi].
    if (i > mid)                a[k] = aux[j++];
    else if (j > hi)            a[k] = aux[i++];
    else if (less(aux[j], aux[i])) a[k] = aux[j++];
    else                        a[k] = aux[i++];
}

```

This method merges by first copying into the auxiliary array `aux[]` then merging back to `a[]`. In the merge (the second for loop), there are four conditions: left half exhausted (take from the right), right half exhausted (take from the left), current key on right less than current key on left (take from the right), and current key on right greater than or equal to current key on left (take from the left).

	a[]										i	j	aux[]									
	0	1	2	3	4	5	6	7	8	9			0	1	2	3	4	5	6	7	8	9
input	E	E	G	M	R	A	C	E	R	T			-	-	-	-	-	-	-	-	-	-
copy	E	E	G	M	R	A	C	E	R	T			E	E	G	M	R	A	C	E	R	T
											0	5										
0	A										0	6	E	E	G	M	R	A	C	E	R	T
1	A	C									0	7	E	E	G	M	R		C	E	R	T
2	A	C	E								1	7	E	E	G	M	R			E	R	T
3	A	C	E	E							2	7		E	G	M	R			E	R	T
4	A	C	E	E	E						2	8			G	M	R			E	R	T
5	A	C	E	E	E	G					3	8			G	M	R				R	T
6	A	C	E	E	E	G	M				4	8				M	R				R	T
7	A	C	E	E	E	G	M	R			5	8					R				R	T
8	A	C	E	E	E	G	M	R	R		5	9									R	T
9	A	C	E	E	E	G	M	R	R	T	6	10										T
merged result	A	C	E	E	E	G	M	R	R	T												

Abstract in-place merge trace

Top-down mergesort ALGORITHM 2.4 is a recursive mergesort implementation based on this abstract in-place merge. It is one of the best-known examples of the utility of the *divide-and-conquer* paradigm for efficient algorithm design. This recursive code is the basis for an inductive proof that the algorithm sorts the array: if it sorts the two subarrays, it sorts the whole array, by merging together the subarrays.

To understand mergesort, it is worthwhile to consider carefully the dynamics of the method calls, shown in the trace at right. To sort $a[0..15]$, the `sort()` method calls itself to sort $a[0..7]$ then calls itself to sort $a[0..3]$ and $a[4..7]$ before finally doing the first merge of $a[0]$ with $a[1]$ after calling itself to sort $a[0]$ and then $a[1]$ (for brevity, we omit the calls for the base-case 1-entry sorts in the trace). Then the next merge is $a[2]$ with $a[3]$ and then $a[0..1]$ with $a[2..3]$ and so forth. From this trace, we see that the sort code simply provides an organized way to sequence the calls to the `merge()` method. This insight will be useful later in this section.

The recursive code also provides us with the basis for analyzing mergesort's running time. Because mergesort is a prototype of the divide-and-conquer algorithm design paradigm, we will consider this analysis in detail.

```

sort(a, 0, 15)
  sort left half (a, 0, 7)
    sort(a, 0, 3)
      sort(a, 0, 1)
        merge(a, 0, 0, 1)
      sort(a, 2, 3)
        merge(a, 2, 2, 3)
      merge(a, 0, 1, 3)
    sort(a, 4, 7)
      sort(a, 4, 5)
        merge(a, 4, 4, 5)
      sort(a, 6, 7)
        merge(a, 6, 6, 7)
      merge(a, 4, 5, 7)
    merge(a, 0, 3, 7)
  sort right half (a, 8, 15)
    sort(a, 8, 11)
      sort(a, 8, 9)
        merge(a, 8, 8, 9)
      sort(a, 10, 11)
        merge(a, 10, 10, 11)
      merge(a, 8, 9, 11)
    sort(a, 12, 15)
      sort(a, 12, 13)
        merge(a, 12, 12, 13)
      sort(a, 14, 15)
        merge(a, 14, 14, 15)
      merge(a, 12, 13, 15)
    merge(a, 8, 11, 15)
  merge results (a, 0, 7, 15)

```

Top-down mergesort call trace

Proposition F. Top-down mergesort uses between $\frac{1}{2}N \lg N$ and $N \lg N$ compares to sort any array of length N .

Proof: Let $C(N)$ be the number of compares needed to sort an array of length N . We have $C(0) = C(1) = 0$ and for $N > 0$ we can write a recurrence relationship that directly mirrors the recursive `sort()` method to establish an upper bound:

$$C(N) \leq C(\lfloor N/2 \rfloor) + C(\lceil N/2 \rceil) + N$$

The first term on the right is the number of compares to sort the left half of the array, the second term is the number of compares to sort the right half, and the third

ALGORITHM 2.4 Top-down mergesort

```

public class Merge
{
    private static Comparable[] aux;    // auxiliary array for merges

    public static void sort(Comparable[] a)
    {
        aux = new Comparable[a.length];    // Allocate space just once.
        sort(a, 0, a.length - 1);
    }

    private static void sort(Comparable[] a, int lo, int hi)
    { // Sort a[lo..hi].
        if (hi <= lo) return;
        int mid = lo + (hi - lo)/2;
        sort(a, lo, mid);    // Sort left half.
        sort(a, mid+1, hi);    // Sort right half.
        merge(a, lo, mid, hi); // Merge results (code on page 271).
    }
}

```

To sort a subarray $a[lo..hi]$ we divide it into two parts: $a[lo..mid]$ and $a[mid+1..hi]$, sort them independently (via recursive calls), and merge the resulting ordered subarrays to produce the result.

	lo	hi	a[]														
	0	1	2	3	4	5	6	7	8	9	10	11	12	13	14	15	
																	M E R G E S O R T E X A M P L E
merge(a,	0,	0,	1)														E M R G E S O R T E X A M P L E
merge(a,	2,	2,	3)														E M G R E S O R T E X A M P L E
merge(a,	0,	1,	3)														E G M R E S O R T E X A M P L E
merge(a,	4,	4,	5)														E G M R E S O R T E X A M P L E
merge(a,	6,	6,	7)														E G M R E S O R T E X A M P L E
merge(a,	4,	5,	7)														E G M R E O R S T E X A M P L E
merge(a,	0,	3,	7)														E E G M O R R S T E X A M P L E
merge(a,	8,	8,	9)														E E G M O R R S E T X A M P L E
merge(a,	10,	10,	11)														E E G M O R R S E T A X M P L E
merge(a,	8,	9,	11)														E E G M O R R S A E T X M P L E
merge(a,	12,	12,	13)														E E G M O R R S A E T X M P L E
merge(a,	14,	14,	15)														E E G M O R R S A E T X M P E L
merge(a,	12,	13,	15)														E E G M O R R S A E T X E L M P
merge(a,	8,	11,	15)														E E G M O R R S A E E L M P T X
merge(a,	0,	7,	15)														A E E E E G L M M O P R R S T X

Trace of merge results for top-down mergesort

term is the number of compares for the merge. The lower bound

$$C(N) \geq C(\lfloor N/2 \rfloor) + C(\lceil N/2 \rceil) + \lfloor N/2 \rfloor$$

follows because the number of compares for the merge is at least $\lfloor N/2 \rfloor$.

We derive an exact solution to the recurrence when equality holds and N is a power of 2 (say $N = 2^n$). First, since $\lfloor N/2 \rfloor = \lceil N/2 \rceil = 2^{n-1}$, we have

$$C(2^n) = 2C(2^{n-1}) + 2^n$$

Dividing both sides by 2^n gives

$$C(2^n)/2^n = C(2^{n-1})/2^{n-1} + 1$$

Applying the same equation to the first term on the right, we have

$$C(2^n)/2^n = C(2^{n-2})/2^{n-2} + 1 + 1$$

Repeating the previous step $n - 1$ additional times gives

$$C(2^n)/2^n = C(2^0)/2^0 + n$$

which, after multiplying both sides by 2^n , leaves us with the solution

$$C(N) = C(2^n) = n2^n = N \lg N$$

Exact solutions for general N are more complicated, but it is not difficult to apply the same argument to the inequalities describing the bounds on the number of compares to prove the stated result for all values of N . This proof is valid no matter what the input values are and no matter in what order they appear.

Another way to understand PROPOSITION F is to examine the tree drawn below, where each node depicts a subarray for which `sort()` does a `merge()`. The tree has precisely n levels. For k from 0 to $n - 1$, the k th level from the top depicts 2^k subarrays, each of length 2^{n-k} , each of which thus requires at most 2^{n-k} compares for the merge. Thus we have $2^k \cdot 2^{n-k} = 2^n$ total cost for each of the n levels, for a total of $n2^n = N \lg N$.

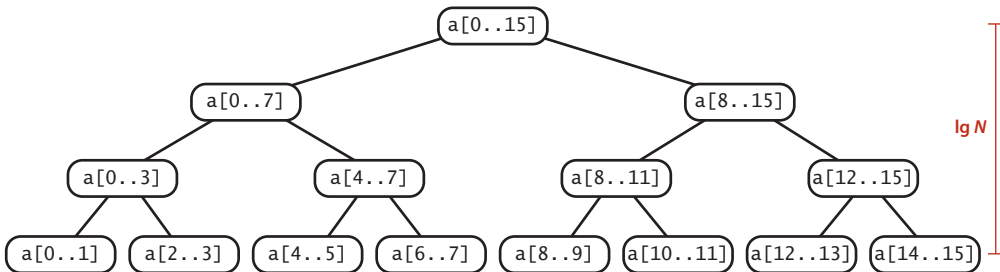

Mergesort subarray dependence tree for $N = 16$

Proposition G. Top-down mergesort uses at most $6N \lg N$ array accesses to sort an array of length N .

Proof: Each merge uses at most $6N$ array accesses ($2N$ for the copy, $2N$ for the move back, and at most $2N$ for compares). The result follows from the same argument as for PROPOSITION F.

PROPOSITIONS F and G tell us that we can expect the time required by mergesort to be proportional to $N \log N$. That fact brings us to a different level from the elementary methods in SECTION 2.1 because it tells us that we can sort huge arrays using just a logarithmic factor more time than it takes to examine every entry. You can sort millions of items (or more) with mergesort, but not with insertion sort or selection sort. The primary drawback of mergesort is that it requires extra space proportional to N , for the auxiliary array for merging. If space is at a premium, we need to consider another method. On the other hand, we can cut the running time of mergesort substantially with some carefully considered modifications to the implementation.

Use insertion sort for small subarrays. We can improve most recursive algorithms by handling small cases differently, because the recursion *guarantees* that the method will be used often for small cases, so improvements in handling them lead to improvements in the whole algorithm. In the case of sorting, we know that insertion sort (or selection sort) is simple and therefore likely to be faster than mergesort for tiny subarrays. As usual, a visual trace provides insight into the operation of mergesort. The visual trace on the facing page shows the operation of a mergesort implementation with a cutoff for small subarrays. Switching to insertion sort for small subarrays (length 15 or less, say) will improve the running time of a typical mergesort implementation by 10 to 15 percent (see EXERCISE 2.2.23).

Test whether the array is already in order. We can reduce the running time to be linear for arrays that are already in order by adding a test to skip the call to `merge()` if `a[mid]` is less than or equal to `a[mid+1]`. With this change, we still do all the recursive calls, but the running time for any sorted subarray is linear (see EXERCISE 2.2.8).

Eliminate the copy to the auxiliary array. It is possible to eliminate the time (but not the space) taken to copy to the auxiliary array used for merging. To do so, we use two invocations of the sort method: one takes its input from the given array and puts the sorted output in the auxiliary array; the other takes its input from the auxiliary array and puts the sorted output in the given array. With this approach, in a bit of recursive trickery, we can arrange the recursive calls such that the computation switches the roles of the input array and the auxiliary array at each level (see EXERCISE 2.2.11).

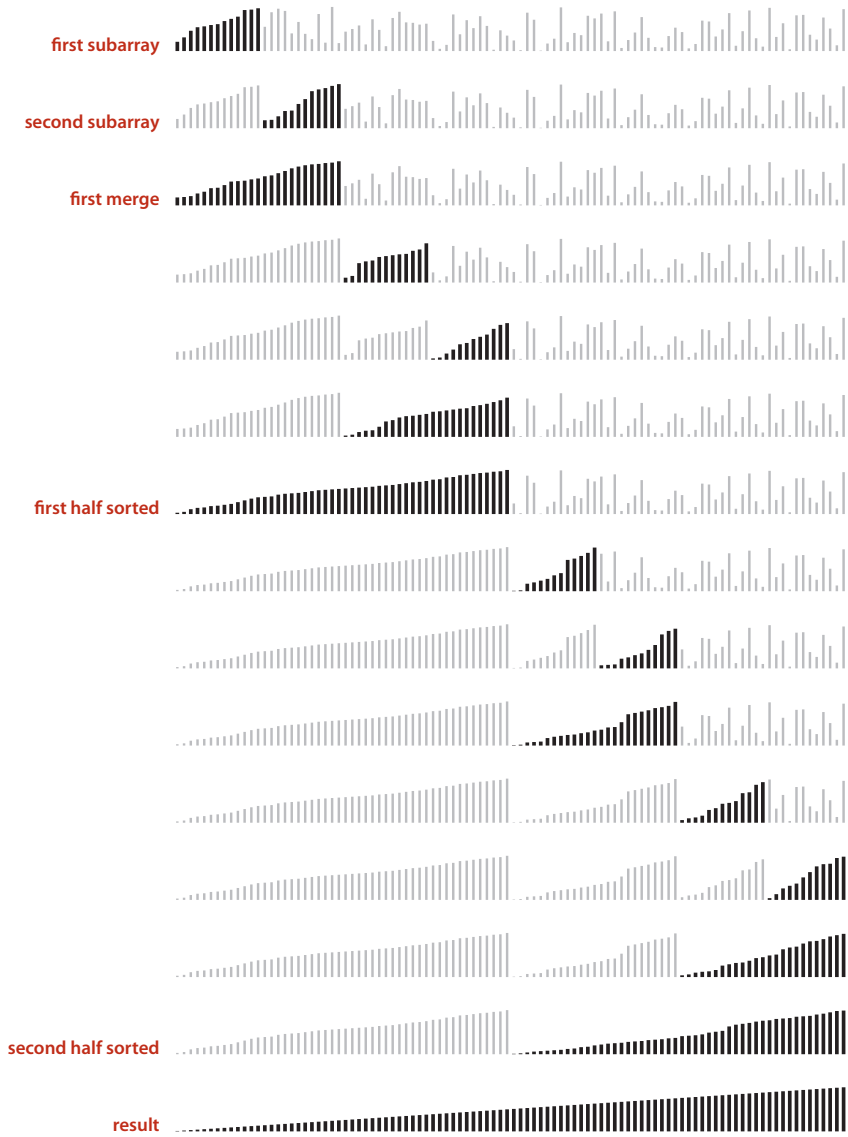

Visual trace of top-down mergesort with cutoff for small subarrays

It is appropriate to repeat here a point raised in CHAPTER 1 that is easily forgotten and needs reemphasis. Locally, we treat each algorithm in this book as if it were critical in some application. Globally, we try to reach general conclusions about which approach to recommend. Our discussion of such improvements is not necessarily a recommendation to always implement them, rather a warning not to draw absolute conclusions about performance from initial implementations. When addressing a new problem, your best bet is to use the simplest implementation with which you are comfortable and then refine it if it becomes a bottleneck. Addressing improvements that decrease running time just by a constant factor may not otherwise be worthwhile. You need to test the effectiveness of specific improvements by running experiments, as we indicate in exercises throughout.

In the case of mergesort, the three improvements just listed are simple to implement and are of interest when mergesort is the method of choice—for example, in situations discussed at the end of this chapter.

Bottom-up mergesort The recursive implementation of mergesort is prototypical of the *divide-and-conquer* algorithm design paradigm, where we solve a large problem by dividing it into pieces, solving the subproblems, then using the solutions for the pieces to solve the whole problem. Even though we are thinking in terms of merging together two large subarrays, the fact is that most merges are merging together tiny subarrays. Another way to implement mergesort is to organize the merges so that we do all the merges of tiny subarrays on one pass, then do a second pass to merge those subarrays in pairs, and so forth, continuing until we do a merge that encompasses the whole array. This method requires even less code than the standard recursive implementation. We start by doing a pass of 1-by-1 merges (considering individual items as subarrays of size 1), then a pass of 2-by-2 merges (merge subarrays of size 2 to make subarrays of size 4), then 4-by-4 merges, and so forth. The second subarray may be smaller than the first in the last merge on each pass (which is no problem for `merge()`), but otherwise all merges involve subarrays of equal size, doubling the sorted subarray size for the next pass.

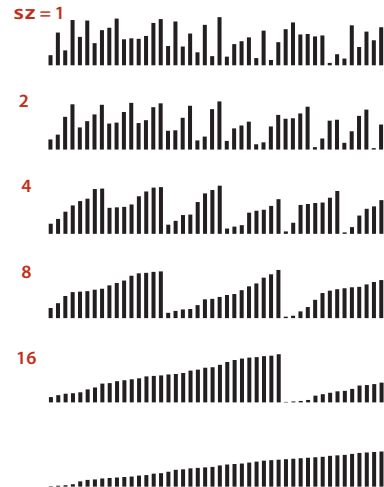

Visual trace of bottom-up mergesort

Bottom-up mergesort

```

public class MergeBU
{
    private static Comparable[] aux;           // auxiliary array for merges
    // See page 271 for merge() code.

    public static void sort(Comparable[] a)
    { // Do lg N passes of pairwise merges.
        int N = a.length;
        aux = new Comparable[N];
        for (int sz = 1; sz < N; sz = sz+sz) // sz: subarray size
            for (int lo = 0; lo < N-sz; lo += sz+sz) // lo: subarray index
                merge(a, lo, lo+sz-1, Math.min(lo+sz+sz-1, N-1));
    }
}

```

Bottom-up mergesort consists of a sequence of passes over the whole array, doing *sz*-by-*sz* merges, starting with *sz* equal to 1 and doubling *sz* on each pass. The final subarray is of size *sz* only when the array size is an even multiple of *sz* (otherwise it is less than *sz*).

	a[i]															
	0	1	2	3	4	5	6	7	8	9	10	11	12	13	14	15
sz = 1	M	E	R	G	E	S	O	R	T	E	X	A	M	P	L	E
merge(a, 0, 0, 1)	E	M	R	G	E	S	O	R	T	E	X	A	M	P	L	E
merge(a, 2, 2, 3)	E	M	G	R	E	S	O	R	T	E	X	A	M	P	L	E
merge(a, 4, 4, 5)	E	M	G	R	E	S	O	R	T	E	X	A	M	P	L	E
merge(a, 6, 6, 7)	E	M	G	R	E	S	O	R	T	E	X	A	M	P	L	E
merge(a, 8, 8, 9)	E	M	G	R	E	S	O	R	E	T	X	A	M	P	L	E
merge(a, 10, 10, 11)	E	M	G	R	E	S	O	R	E	T	A	X	M	P	L	E
merge(a, 12, 12, 13)	E	M	G	R	E	S	O	R	E	T	A	X	M	P	L	E
merge(a, 14, 14, 15)	E	M	G	R	E	S	O	R	E	T	A	X	M	P	E	L
sz = 2	E	G	M	R	E	S	O	R	E	T	A	X	M	P	E	L
merge(a, 0, 1, 3)	E	G	M	R	E	O	R	S	E	T	A	X	M	P	E	L
merge(a, 4, 5, 7)	E	G	M	R	E	O	R	S	A	E	T	X	M	P	E	L
merge(a, 8, 9, 11)	E	G	M	R	E	O	R	S	A	E	T	X	M	P	E	L
merge(a, 12, 13, 15)	E	G	M	R	E	O	R	S	A	E	T	X	E	L	M	P
sz = 4	E	E	G	M	O	R	R	S	A	E	T	X	E	L	M	P
merge(a, 0, 3, 7)	E	E	G	M	O	R	R	S	A	E	E	L	M	P	T	X
merge(a, 8, 11, 15)	E	E	G	M	O	R	R	S	A	E	E	L	M	P	T	X
sz = 8	A	E	E	E	E	G	L	M	M	O	P	R	R	S	T	X
merge(a, 0, 7, 15)	A	E	E	E	E	G	L	M	M	O	P	R	R	S	T	X

Trace of merge results for bottom-up mergesort

Proposition H. Bottom-up mergesort uses between $\frac{1}{2}N \lg N$ and $N \lg N$ compares and at most $6N \lg N$ array accesses to sort an array of length N .

Proof: The number of passes through the array is precisely $\lceil \lg N \rceil$ (that is precisely the value of n such that $2^n \leq N < 2^{n+1}$). For each pass, the number of array accesses is exactly $6N$ and the number of compares is at most N and no less than $N/2$.

WHEN THE ARRAY LENGTH IS A POWER OF 2, top-down and bottom-up mergesort perform precisely the same compares and array accesses, just in a different order. When the array length is not a power of 2, the sequence of compares and array accesses for the two algorithms will be different (see EXERCISE 2.2.5).

A version of bottom-up mergesort is the method of choice for sorting data organized in a *linked list*. Consider the list to be sorted sublists of size 1, then pass through to make sorted subarrays of size 2 linked together, then size 4, and so forth. This method rearranges the links to sort the list *in place* (without creating any new list nodes).

Both the top-down and bottom-up approaches to implementing a divide-and-conquer algorithm are intuitive. The lesson that you can take from mergesort is this: Whenever you encounter an algorithm based on one of these approaches, it is worth considering the other. Do you want to solve the problem by breaking it up into smaller problems (and solving them recursively) as in `Merge.sort()` or by building small solutions into larger ones as in `MergeBU.sort()`?

The complexity of sorting One important reason to know about mergesort is that we use it as the basis for proving a fundamental result in the field of *computational complexity* that helps us understand the intrinsic difficulty of sorting. In general, computational complexity plays an important role in the design of algorithms, and this result in particular is directly relevant to the design of sorting algorithms, so we next consider it in detail.

The first step in a study of complexity is to establish a model of computation. Generally, researchers strive to understand the simplest model relevant to a problem. For sorting, we study the class of *compare-based* algorithms that make their decisions about items only on the basis of comparing keys. A compare-based algorithm can do an arbitrary amount of computation between compares, but cannot get any information about a key except by comparing it with another one. Because of our restriction to the `Comparable` API, all of the algorithms in this chapter are in this class (note that we are ignoring the cost of array accesses), as are many algorithms that we might imagine. In CHAPTER 5, we consider algorithms that are not restricted to `Comparable` items.

Proposition I. No compare-based sorting algorithm can guarantee to sort N items with fewer than $\lg(N!) \sim N \lg N$ compares.

Proof: First, we assume that the keys are all distinct, since any algorithm must be able to sort such inputs. Now, we use a binary tree to describe the sequence of compares. Each *node* in the tree is either a *leaf* $(i_0 \ i_1 \ i_2 \ \dots \ i_{N-1})$ that indicates that the sort is complete and has discovered that the original inputs were in the order $a[i_0], a[i_1], \dots, a[i_{N-1}]$, or an *internal node* $(i:j)$ that corresponds to a compare operation between $a[i]$ and $a[j]$, with a left subtree corresponding to the sequence of compares in the case that $a[i]$ is less than $a[j]$, and a right subtree corresponding to what happens if $a[i]$ is greater than $a[j]$. Each path from the root to a leaf corresponds to the sequence of compares that the algorithm uses to establish the ordering given in the leaf. For example, here is a compare tree for $N = 3$:

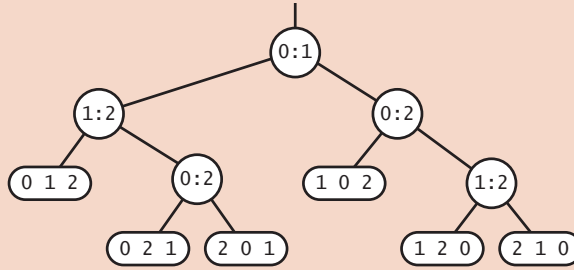

We never explicitly construct such a tree—it is a mathematical device for describing the compares used by any algorithm.

The first key observation in the proof is that the tree must have at least $N!$ leaves because there are $N!$ different permutations of N distinct keys. If there are fewer than $N!$ leaves, then some permutation is missing from the leaves, and the algorithm would fail for that permutation.

The number of internal nodes on a path from the root to a leaf in the tree is the number of compares used by the algorithm for some input. We are interested in the length of the longest such path in the tree (known as the tree *height*) since it measures the worst-case number of compares used by the algorithm. Now, it is a basic combinatorial property of binary trees that a tree of height h has no more than 2^h leaves—the tree of height h with the maximum number of leaves is perfectly balanced, or *complete*. An example for $h = 4$ is diagrammed on the next page.

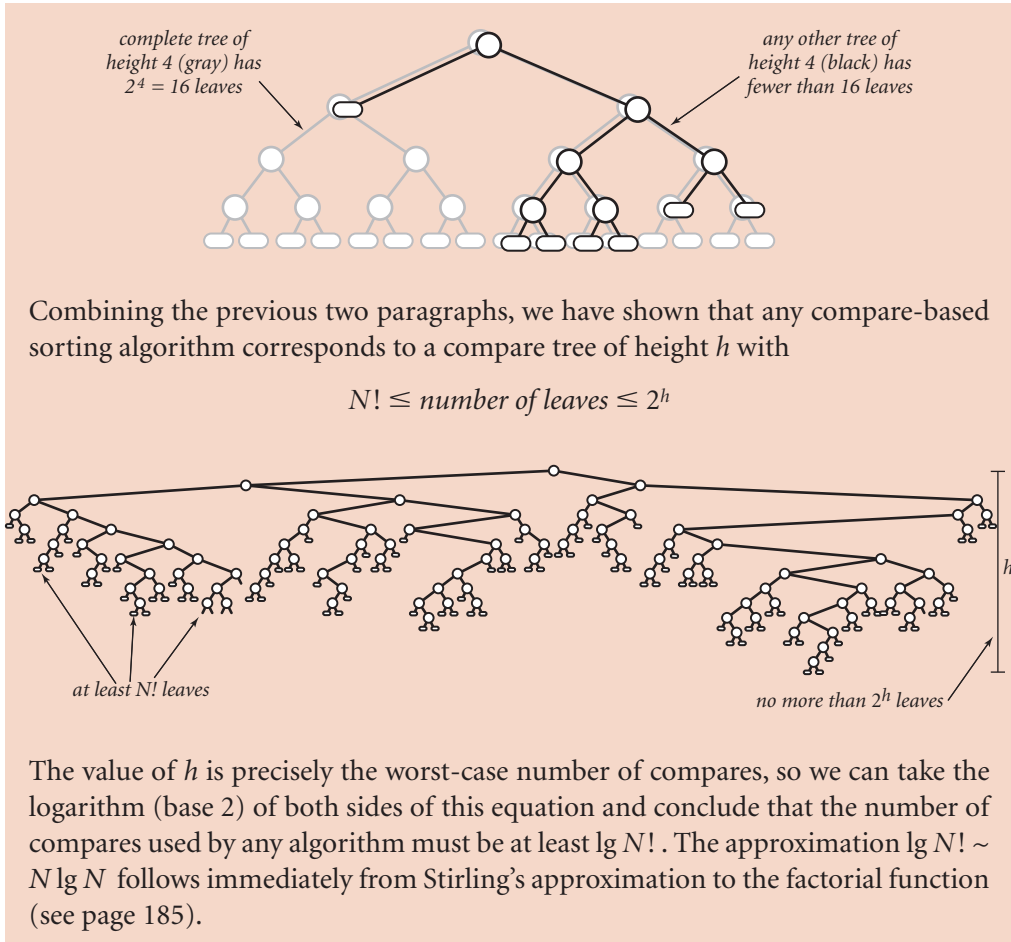

This result serves as a guide for us to know, when designing a sorting algorithm, how well we can expect to do. For example, without such a result, one might set out to try to design a compare-based sorting algorithm that uses half as many compares as does mergesort, in the worst case. The lower bound in PROPOSITION I says that such an effort is futile—*no such algorithm exists*. It is an extremely strong statement that applies to any conceivable compare-based algorithm.

PROPOSITION H asserts that the number of compares used by mergesort in the worst case is $\sim N \lg N$. This result is an *upper bound* on the difficulty of the sorting problem in the sense that a better algorithm would have to guarantee to use a smaller number of compares. PROPOSITION I asserts that no sorting algorithm can guarantee to use fewer

than $\sim N \lg N$ compares. It is a *lower bound* on the difficulty of the sorting problem in the sense that even the best possible algorithm must use at least that many compares in the worst case. Together, they imply:

Proposition J. Mergesort is an asymptotically optimal compare-based sorting algorithm.

Proof: Precisely, we mean by this statement that *both the number of compares used by mergesort in the worst case and the minimum number of compares that any compare-based sorting algorithm can guarantee are $\sim N \lg N$* . PROPOSITIONS H and I establish these facts.

It is important to note that, like the model of computation, we need to precisely define what we mean by an optimal algorithm. For example, we might tighten the definition of optimality and insist that an optimal algorithm for sorting is one that uses *precisely* $\lg N!$ compares. We do not do so because we could not notice the difference between such an algorithm and (for example) mergesort for large N . Or, we might broaden the definition of optimality to include any sorting algorithm whose worst-case number of compares is *within a constant factor* of $N \lg N$. We do not do so because we might very well notice the difference between such an algorithm and mergesort for large N .

COMPUTATIONAL COMPLEXITY MAY SEEM RATHER ABSTRACT, but fundamental research on the intrinsic difficulty of solving computational problems hardly needs justification. Moreover, when it does apply, it is emphatically the case that computational complexity affects the development of good software. First, good upper bounds allow software engineers to provide performance guarantees; there are many documented instances where poor performance has been traced to someone using a quadratic sort instead of a linearithmic one. Second, good lower bounds spare us the effort of searching for performance improvements that are not attainable.

But the optimality of mergesort is not the end of the story and should not be misused to indicate that we need not consider other methods for practical applications. That is not the case because the theory in this section has a number of limitations. For example:

- Mergesort is not optimal with respect to space usage.
- The worst case may not be likely in practice.
- Operations other than compares (such as array accesses) may be important.
- One can sort certain data without using *any* compares.

Thus, we shall be considering several other sorting methods in this book.

Q&A

Q. Is mergesort faster than shellsort?

A. In practice, their running times are within a small constant factor of one another (when shellsort is using a well-tested increment sequence like the one in ALGORITHM 2.3), so comparative performance depends on the implementations.

```
% java SortCompare Merge Shell 100000
For 100000 random Double values
Merge is 1.2 times faster than Shell
```

In theory, no one has been able to prove that shellsort is linearithmic for random data, so there remains the possibility that the asymptotic growth of the average-case performance of shellsort is higher. Such a gap has been proven for worst-case performance, but it is not relevant in practice.

Q. Why not make the `aux[]` array local to `merge()`?

A. To avoid the overhead of creating an array for every merge, even the tiny ones. This cost would dominate the running time of mergesort (see EXERCISE 2.2.26). A more proper solution (which we avoid in the text to reduce clutter in the code) is to make `aux[]` local to `sort()` and pass it as an argument to `merge()` (see EXERCISE 2.2.9).

Q. How does mergesort fare when there are duplicate values in the array?

A. If all the items have the same value, the running time is linear (with the extra test to skip the merge when the array is sorted), but if there is more than one duplicate value, this performance gain is not necessarily realized. For example, suppose that the input array consists of N items with one value in odd positions and N items with another value in even positions. The running time is linearithmic for such an array (it satisfies the same recurrence as for items with distinct values), not linear.

EXERCISES

2.2.1 Give a trace, in the style of the trace given at the beginning of this section, showing how the keys A E Q S U Y E I N O S T are merged with the abstract in-place `merge()` method.

2.2.2 Give traces, in the style of the trace given with ALGORITHM 2.4, showing how the keys E A S Y Q U E S T I O N are sorted with top-down mergesort.

2.2.3 Answer EXERCISE 2.2.2 for bottom-up mergesort.

2.2.4 Does the abstract in-place merge produce proper output if and only if the two input subarrays are in sorted order? Prove your answer, or provide a counterexample.

2.2.5 Give the sequence of subarray sizes in the merges performed by both the top-down and the bottom-up mergesort algorithms, for $N = 39$.

2.2.6 Write a program to compute the exact value of the number of array accesses used by top-down mergesort and by bottom-up mergesort. Use your program to plot the values for N from 1 to 512, and to compare the exact values with the upper bound $6N \lg N$.

2.2.7 Show that the number of compares used by mergesort is monotonically increasing ($C(N+1) > C(N)$ for all $N > 0$).

2.2.8 Suppose that ALGORITHM 2.4 is modified to skip the call on `merge()` whenever $a[\text{mid}] \leq a[\text{mid}+1]$. Prove that the number of compares used to mergesort a sorted array is linear.

2.2.9 Use of a static array like `aux[]` is inadvisable in library software because multiple clients might use the class concurrently. Give an implementation of `Merge` that does not use a static array. Do *not* make `aux[]` local to `merge()` (see the Q&A for this section). *Hint*: Pass the auxiliary array as an argument to the recursive `sort()`.

CREATIVE PROBLEMS

2.2.10 *Faster merge.* Implement a version of `merge()` that copies the second half of `a[]` to `aux[]` in *decreasing order* and then does the merge back to `a[]`. This change allows you to remove the code to test that each of the halves has been exhausted from the inner loop. *Note:* The resulting sort is not stable (see page 341).

2.2.11 *Improvements.* Implement the three improvements to mergesort that are described in the text on page 275: Add a cutoff for small subarrays, test whether the array is already in order, and avoid the copy by switching arguments in the recursive code.

2.2.12 *Sublinear extra space.* Develop a merge implementation that reduces the extra space requirement to $\max(M, N/M)$, based on the following idea: Divide the array into N/M blocks of size M (for simplicity in this description, assume that N is a multiple of M). Then, (i) considering the blocks as items with their first key as the sort key, sort them using selection sort; and (ii) run through the array merging the first block with the second, then the second block with the third, and so forth.

2.2.13 *Lower bound for average case.* Prove that the *expected* number of compares used by any compare-based sorting algorithm must be at least $\sim N \lg N$ (assuming that all possible orderings of the input are equally likely). *Hint:* The expected number of compares is at least the external path length of the compare tree (the sum of the lengths of the paths from the root to all leaves), which is minimized when it is balanced.

2.2.14 *Merging sorted queues.* Develop a static method that takes two queues of sorted items as arguments and returns a queue that results from merging the queues into sorted order.

2.2.15 *Bottom-up queue mergesort.* Develop a bottom-up mergesort implementation based on the following approach: Given N items, create N queues, each containing one of the items. Create a queue of the N queues. Then repeatedly apply the merging operation of EXERCISE 2.2.14 to the first two queues and reinsert the merged queue at the end. Repeat until the queue of queues contains only one queue.

2.2.16 *Natural mergesort.* Write a version of bottom-up mergesort that takes advantage of order in the array by proceeding as follows each time it needs to find two arrays to merge: find a sorted subarray (by incrementing a pointer until finding an entry that is smaller than its predecessor in the array), then find the next, then merge them. Analyze the running time of this algorithm in terms of the array size and the number of

CREATIVE PROBLEMS *(continued)*

maximal increasing sequences in the array.

2.2.17 *Linked-list sort.* Implement a natural mergesort for linked lists. (This is the method of choice for sorting linked lists because it uses no extra space and is guaranteed to be linearithmic.)

2.2.18 *Shuffling a linked list.* Develop and implement a divide-and-conquer algorithm that randomly shuffles a linked list in linearithmic time and logarithmic extra space.

2.2.19 *Inversions.* Develop and implement a linearithmic algorithm for computing the number of inversions in a given array (the number of exchanges that would be performed by insertion sort for that array—see SECTION 2.1). This quantity is related to the *Kendall tau distance*; see SECTION 2.5.

2.2.20 *Indirect sort.* Develop and implement a version of mergesort that does not rearrange the array, but returns an `int[]` array `perm` such that `perm[i]` is the index of the *i*th smallest entry in the array.

2.2.21 *Triplicates.* Given three lists of *N* names each, devise a linearithmic algorithm to determine if there is any name common to all three lists, and if so, return the first such name.

2.2.22 *3-way mergesort.* Suppose instead of dividing in half at each step, you divide into thirds, sort each third, and combine using a 3-way merge. What is the order of growth of the overall running time of this algorithm?

EXPERIMENTS

2.2.23 *Improvements.* Run empirical studies to evaluate the effectiveness of each of the three improvements to mergesort that are described in the text (see EXERCISE 2.2.11). Also, compare the performance of the merge implementation given in the text with the merge described in EXERCISE 2.2.10. In particular, empirically determine the best value of the parameter that decides when to switch to insertion sort for small subarrays.

2.2.24 *Sort-test improvement.* Run empirical studies for large randomly ordered arrays to study the effectiveness of the modification described in EXERCISE 2.2.8 for random data. In particular, develop a hypothesis about the average number of times the test (whether an array is sorted) succeeds, as a function of N (the original array size for the sort).

2.2.25 *Multiway mergesort.* Develop a mergesort implementation based on the idea of doing k -way merges (rather than 2-way merges). Analyze your algorithm, develop a hypothesis regarding the best value of k , and run experiments to validate your hypothesis.

2.2.26 *Array creation.* Use `SortCompare` to get a rough idea of the effect on performance on your machine of creating `aux[]` in `merge()` rather than in `sort()`.

2.2.27 *Subarray lengths.* Run mergesort for large random arrays, and make an empirical determination of the average length of the other subarray when the first subarray exhausts, as a function of N (the sum of the two subarray sizes for a given merge).

2.2.28 *Top-down versus bottom-up.* Use `SortCompare` to compare top-down and bottom-up mergesort for $N=10^3$, 10^4 , 10^5 , and 10^6 .

2.2.29 *Natural mergesort.* Determine empirically the number of passes needed in a natural mergesort (see EXERCISE 2.2.16) for random `Long` keys with $N=10^3$, 10^6 , and 10^9 . *Hint:* You do not need to implement a sort (or even generate full 64-bit keys) to complete this exercise.

2.3 QUICKSORT

THE SUBJECT OF THIS SECTION is the sorting algorithm that is probably used more widely than any other, *quicksort*. Quicksort is popular because it is not difficult to implement, works well for a variety of different kinds of input data, and is substantially faster than any other sorting method in typical applications. The quicksort algorithm's desirable features are that it is in-place (uses only a small auxiliary stack) and that it requires time proportional to $N \log N$ on the average to sort an array of length N . None of the algorithms that we have so far considered combine these two properties. Furthermore, quicksort has a shorter inner loop than most other sorting algorithms, which means that it is fast in practice as well as in theory. Its primary drawback is that it is fragile in the sense that some care is involved in the implementation to be sure to avoid bad performance. Numerous examples of mistakes leading to quadratic performance in practice are documented in the literature. Fortunately, the lessons learned from these mistakes have led to various improvements to the algorithm that make it of even broader utility, as we shall see.

The basic algorithm Quicksort is a divide-and-conquer method for sorting. It works by *partitioning* an array into two subarrays, then sorting the subarrays independently. Quicksort is complementary to mergesort: for mergesort, we break the array into two subarrays to be sorted and then combine the ordered subarrays to make the whole ordered array; for quicksort, we rearrange the array such that, when the two subarrays are sorted, the whole array is ordered. In the first instance, we do the two recursive calls *before* working on the whole array; in the second instance, we do the two recursive calls *after* working on the whole array. For mergesort, the array is divided in half; for quicksort, the position of the partition depends on the contents of the array.

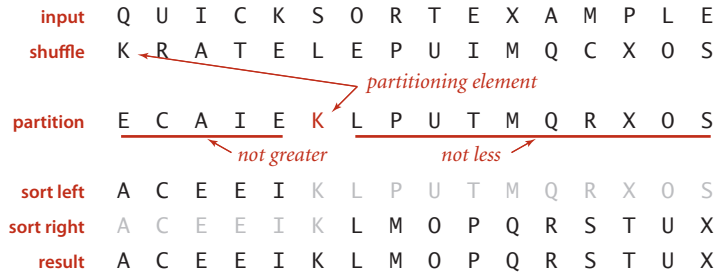

Quicksort overview

ALGORITHM 2.5 Quicksort

```

public class Quick
{
    public static void sort(Comparable[] a)
    {
        StdRandom.shuffle(a);           // Eliminate dependence on input.
        sort(a, 0, a.length - 1);
    }

    private static void sort(Comparable[] a, int lo, int hi)
    {
        if (hi <= lo) return;
        int j = partition(a, lo, hi);   // Partition (see page 291).
        sort(a, lo, j-1);               // Sort left part a[lo .. j-1].
        sort(a, j+1, hi);               // Sort right part a[j+1 .. hi].
    }
}

```

Quicksort is a recursive program that sorts a subarray $a[lo \dots hi]$ by using a `partition()` method that puts $a[i]$ into position and arranges the rest of the entries such that the recursive calls finish the sort.

	lo	j	hi	0	1	2	3	4	5	6	7	8	9	10	11	12	13	14	15
initial values				Q	U	I	C	K	S	O	R	T	E	X	A	M	P	L	E
random shuffle				K	R	A	T	E	L	E	P	U	I	M	Q	C	X	O	S
	0	5	15	E	C	A	I	E	K	L	P	U	T	M	Q	R	X	O	S
	0	3	4	E	C	A	E	I	K	L	P	U	T	M	Q	R	X	O	S
	0	2	2	A	C	E	E	I	K	L	P	U	T	M	Q	R	X	O	S
	0	0	1	A	C	E	E	I	K	L	P	U	T	M	Q	R	X	O	S
	1		1	A	C	E	E	I	K	L	P	U	T	M	Q	R	X	O	S
	4		4	A	C	E	E	I	K	L	P	U	T	M	Q	R	X	O	S
	6	6	15	A	C	E	E	I	K	L	P	U	T	M	Q	R	X	O	S
	7	9	15	A	C	E	E	I	K	L	M	O	P	T	Q	R	X	U	S
	7	7	8	A	C	E	E	I	K	L	M	O	P	T	Q	R	X	U	S
	8		8	A	C	E	E	I	K	L	M	O	P	T	Q	R	X	U	S
	10	13	15	A	C	E	E	I	K	L	M	O	P	S	Q	R	T	U	X
	10	12	12	A	C	E	E	I	K	L	M	O	P	R	Q	S	T	U	X
	10	11	11	A	C	E	E	I	K	L	M	O	P	Q	R	S	T	U	X
	10	10	10	A	C	E	E	I	K	L	M	O	P	Q	R	S	T	U	X
	14	14	15	A	C	E	E	I	K	L	M	O	P	Q	R	S	T	U	X
	15		15	A	C	E	E	I	K	L	M	O	P	Q	R	S	T	U	X
result				A	C	E	E	I	K	L	M	O	P	Q	R	S	T	U	X

no partition for subarrays of size 1

The crux of the method is the partitioning process, which rearranges the array to make the following three conditions hold:

- The entry $a[j]$ is in its final place in the array, for some j .
- No entry in $a[l_0]$ through $a[j-1]$ is greater than $a[j]$.
- No entry in $a[j+1]$ through $a[h_i]$ is less than $a[j]$.

We achieve a complete sort by partitioning, then recursively applying the method.

Because the partitioning process always fixes one item into its position, a formal proof by induction that the recursive method constitutes a proper sort is not difficult to develop: if the left subarray and the right subarray are both properly sorted, then the result array, made up of the left subarray (in order, with no entry larger than the partitioning item), the partitioning item, and the right subarray (in order, with no entry smaller than the partitioning item), is in order. ALGORITHM 2.5 is a recursive program

that implements this idea. It is a *randomized* algorithm, because it randomly shuffles the array before sorting it. Our reason for doing so is to be able to predict (and depend upon) its performance characteristics, as discussed below.

To complete the implementation, we need to implement the partitioning method. We use the following general strategy: First, we arbitrarily choose $a[l_0]$ to be the *partitioning item*—the one that will go into its final position. Next, we scan from the left end of the array until we find an entry greater than (or equal to) the partitioning item, and we scan from the right end of the array until we find an entry less than (or equal to) the partitioning item. The two items that

stopped the scans are out of place in the final partitioned array, so we exchange them. Continuing in this way, we ensure that no array entries to the left of the left index i are greater than the partitioning item, and no array entries to the right of the right index j are less than the partitioning item. When the scan indices cross, all that we need to do to complete the partitioning process is to exchange the partitioning item $a[l_0]$ with the rightmost entry of the left subarray ($a[j]$) and return its index j .

There are several subtle issues with respect to implementing quicksort that are reflected in this code and worthy of mention, because each either can lead to incorrect code or can significantly impact performance. Next, we discuss several of these issues. Later in this section, we will consider three important higher-level algorithmic improvements.

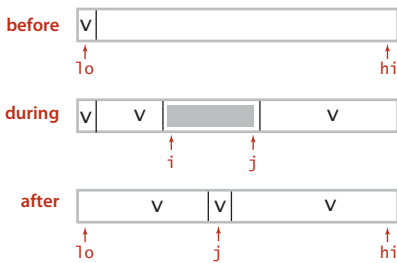

QuickSort partitioning overview

Quicksort partitioning

```

private static int partition(Comparable[] a, int lo, int hi)
{ // Partition into a[lo..i-1], a[i], a[i+1..hi].
  int i = lo, j = hi+1;           // left and right scan indices
  Comparable v = a[lo];         // partitioning item
  while (true)
  { // Scan right, scan left, check for scan complete, and exchange.
    while (less(a[++i], v)) if (i == hi) break;
    while (less(v, a[--j])) if (j == lo) break;
    if (i >= j) break;
    exch(a, i, j);
  }
  exch(a, lo, j);               // Put v = a[j] into position
  return j;                     // with a[lo..j-1] <= a[j] <= a[j+1..hi].
}

```

This code partitions on the item v in $a[lo]$. The main loop exits when the scan indices i and j cross. Within the loop, we increment i while $a[i]$ is less than v and decrement j while $a[j]$ is greater than v , then do an exchange to maintain the invariant property that no entries to the left of i are greater than v and no entries to the right of j are smaller than v . Once the indices meet, we complete the partitioning by exchanging $a[lo]$ with $a[j]$ (thus leaving the partitioning value in $a[j]$).

	i	j	v	a[]															
				0	1	2	3	4	5	6	7	8	9	10	11	12	13	14	15
initial values	0	16	K	R	A	T	E	L	E	P	U	I	M	Q	C	X	O	S	
scan left, scan right	1	12	K	R	A	T	E	L	E	P	U	I	M	Q	C	X	O	S	
exchange	1	12	K	C	A	T	E	L	E	P	U	I	M	Q	R	X	O	S	
scan left, scan right	3	9	K	C	A	T	E	L	E	P	U	I	M	Q	R	X	O	S	
exchange	3	9	K	C	A	I	E	L	E	P	U	T	M	Q	R	X	O	S	
scan left, scan right	5	6	K	C	A	I	E	L	E	P	U	T	M	Q	R	X	O	S	
exchange	5	6	K	C	A	I	E	E	L	P	U	T	M	Q	R	X	O	S	
scan left, scan right	6	5	K	C	A	I	E	E	L	P	U	T	M	Q	R	X	O	S	
final exchange	6	5	E	C	A	I	E	K	L	P	U	T	M	Q	R	X	O	S	
result		5	E	C	A	I	E	K	L	P	U	T	M	Q	R	X	O	S	

Partitioning trace (array contents before and after each exchange)

Partitioning in place. If we use an extra array, partitioning is easy to implement, but not so much easier that it is worth the extra cost of copying the partitioned version back into the original. A novice Java programmer might even create a new spare array within the recursive method, for each partition, which would drastically slow down the sort.

Staying in bounds. If the smallest item or the largest item in the array is the partitioning item, we have to take care that the pointers do not run off the left or right ends of the array, respectively. Our `partition()` implementation has explicit tests to guard against this circumstance. The test (`j == 1o`) is redundant, since the partitioning item is at `a[1o]` and not less than itself. With a similar technique on the right it is not difficult to eliminate both tests (see EXERCISE 2.3.17).

Preserving randomness. The random shuffle puts the array in random order. Since it treats all items in the subarrays uniformly, ALGORITHM 2.5 has the property that its two subarrays are also in random order. This fact is crucial to the predictability of the algorithm's running time. An alternate way to preserve randomness is to choose a random item for partitioning within `partition()`.

Terminating the loop. Experienced programmers know to take special care to ensure that any loop must always terminate, and the partitioning loop for quicksort is no exception. Properly testing whether the pointers have crossed is a bit trickier than it might seem at first glance. A common error is to fail to take into account that the array might contain other items with the same key value as the partitioning item.

Handling items with keys equal to the partitioning item's key. It is best to stop the left scan for items with keys greater than *or equal to* the partitioning item's key and the right scan for items with key less than *or equal to* the partitioning item's key, as in ALGORITHM 2.5. Even though this policy might seem to create unnecessary exchanges involving items with keys equal to the partitioning item's key, it is crucial to avoiding quadratic running time in certain typical applications (see EXERCISE 2.3.11). Later, we discuss a better strategy for the case when the array contains a large number of items with equal keys.

Terminating the recursion. Experienced programmers also know to take special care to ensure that any recursive method must always terminate, and quicksort is again no exception. For instance, a common mistake in implementing quicksort involves not ensuring that one item is always put into position, then falling into an infinite recursive loop when the partitioning item happens to be the largest or smallest item in the array.

Performance characteristics Quicksort has been subjected to very thorough mathematical analysis, so that we can make precise statements about its performance. The analysis has been validated through extensive empirical experience, and is a useful tool in tuning the algorithm for optimum performance.

The inner loop of quicksort (in the partitioning method) increments an index and compares an array entry against a fixed value. This simplicity is one factor that makes quicksort quick: it is hard to envision a shorter inner loop in a sorting algorithm. For example, mergesort and shellsort are typically slower than quicksort because they also do data movement within their inner loops.

The second factor that makes quicksort quick is that it uses few compares. Ultimately, the efficiency of the sort depends on how well the partitioning divides the array, which in turn depends on the value of the partitioning item's key. Partitioning divides a large randomly ordered array into two smaller randomly ordered subarrays, but the actual split is equally likely (for distinct keys) to be anywhere in the array. Next, we consider the analysis of the algorithm, which allows us to see how this choice compares to the ideal choice.

The best case for quicksort is when each partitioning stage divides the array exactly in half. This circumstance would make the number of compares used by quicksort satisfy the divide-and-conquer recurrence $C_N = 2C_{N/2} + N$. The $2C_{N/2}$ term covers the cost of sorting the two subarrays; the N is the cost of examining each entry, using one partitioning index or the other. As in the proof of PROPOSITION F for mergesort, we know that this recurrence has the solution $C_N \sim N \lg N$. Although things do not always go this well, it is true that the partition falls in the middle *on the average*. Taking into account the precise probability of each partition position makes the recurrence more complicated and more difficult to solve, but the final result is similar. The proof of this result is the basis for our confidence in quicksort. If you are not mathematically inclined, you may wish to skip (and trust) it; if you *are* mathematically inclined, you may find it intriguing.

Proposition K. Quicksort uses $\sim 2N \ln N$ compares (and one-sixth that many exchanges) on the average to sort an array of length N with distinct keys.

Proof: Let C_N be the average number of compares needed to sort N items with distinct values. We have $C_0 = C_1 = 0$ and for $N > 1$ we can write a recurrence relationship that directly mirrors the recursive program:

$$C_N = N + 1 + (C_0 + C_1 + \dots + C_{N-2} + C_{N-1})/N + (C_{N-1} + C_{N-2} + \dots + C_0)/N$$

The first term is the cost of partitioning (always $N + 1$), the second term is the average cost of sorting the left subarray (which is equally likely to be any size from 0 to $N - 1$), and the third term is the average cost for the right subarray (which is the same as for the left subarray). Multiplying by N and collecting terms transforms this equation to

$$NC_N = N(N + 1) + 2(C_0 + C_1 + \dots + C_{N-2} + C_{N-1})$$

Subtracting this from the same equation for $N - 1$ gives

$$NC_N - (N - 1)C_{N-1} = 2N + 2C_{N-1}$$

Rearranging terms and dividing by $N(N + 1)$ leaves

$$C_N/(N + 1) = C_{N-1}/N + 2/(N + 1)$$

which telescopes to give the result

$$C_N \sim 2(N + 1)(1/3 + 1/4 + \dots + 1/(N + 1))$$

The parenthesized quantity is the discrete estimate of the area under the curve $2/x$ from 3 to $N + 1$ and $C_N \sim 2N \ln N$ by integration. Note that $2N \ln N \approx 1.39N \lg N$, so the average number of compares is only about 39 percent higher than in the best case.

A similar (but much more complicated) analysis is needed to establish the stated result for exchanges.

When keys may not be distinct, as is typical in practical applications, precise analysis is considerably more complicated, but it is not difficult to show that the average number of compares is no greater than C_N , even when duplicate keys may be present (on page 296, we will look at a way to *improve* quicksort in this case).

Despite its many assets, the basic quicksort program has one potential liability: it can be extremely inefficient if the partitions are unbalanced. For example, it could be the case that the first partition is on the smallest item, the second partition on the next smallest item, and so forth, so that the program will remove just one item for each call, leading to an excessive number of partitions of large subarrays. Avoiding this situation is the primary reason that we randomly shuffle the array before using quicksort. This action makes it so unlikely that bad partitions will happen consistently that we need not worry about the possibility.

Proposition L. Quicksort uses $\sim N^2/2$ compares in the worst case, but random shuffling protects against this case.

Proof: By the argument just given, the number of compares used when one of the subarrays is empty for every partition is

$$N + (N - 1) + (N - 2) + \dots + 2 + 1 = (N + 1) N / 2$$

This behavior means not only that the time required will be quadratic but also that the space required to handle the recursion will be linear, which is unacceptable for large arrays. But (with quite a bit more work) it is possible to extend the analysis that we did for the average to find that the standard deviation of the number of compares is about $.65N$, so the running time tends to the average as N grows and is unlikely to be far from the average. For example, even the rough estimate provided by Chebyshev's inequality says that the probability that the running time is more than ten times the average for an array with a million elements is less than $.00001$ (and the true probability is far smaller). The probability that the running time for a large array is close to quadratic is so remote that we can safely ignore the possibility (see EXERCISE 2.3.10). For example, the probability that quicksort will use as many compares as insertion sort or selection sort when sorting a large array on your computer is much less than the probability that your computer will be struck by lightning during the sort!

IN SUMMARY, you can be sure that the running time of ALGORITHM 2.5 will be within a constant factor of $1.39N \lg N$ whenever it is used to sort N items. The same is true of mergesort, but quicksort is typically faster because (even though it does 39 percent more compares) it does much less data movement. This mathematical assurance is probabilistic, but you can certainly rely upon it.

Algorithmic improvements Quicksort was invented in 1960 by C. A. R. Hoare, and many people have studied and refined it since that time. It is tempting to try to develop ways to improve quicksort: a faster sorting algorithm is computer science's "better mousetrap," and quicksort is a venerable method that seems to invite tinkering. Almost from the moment Hoare first published the algorithm, people began proposing ways to improve the algorithm. Not all of these ideas are fully successful, because the algorithm is so well-balanced that the effects of improvements can be more than offset by unexpected side effects, but a few of them, which we now consider, are quite effective.

If your sort code is to be used a great many times or to sort a huge array (or, in particular, if it is to be used as a library sort that will be used to sort arrays of unknown characteristics), then it is worthwhile to consider the improvements that are discussed in the next few paragraphs. As noted, you need to run experiments to determine the effectiveness of these improvements and to determine the best choice of parameters for your implementation. Typically, improvements of 20 to 30 percent are available.

Cutoff to insertion sort. As with most recursive algorithms, an easy way to improve the performance of quicksort is based on the following two observations:

- Quicksort is slower than insertion sort for tiny subarrays.
- Being recursive, quicksort's `sort()` is certain to call itself for tiny subarrays.

Accordingly, it pays to switch to insertion sort for tiny subarrays. A simple change to ALGORITHM 2.5 accomplishes this improvement: replace the statement

```
if (hi <= lo) return;
```

in `sort()` with a statement that invokes insertion sort for small subarrays:

```
if (hi <= lo + M) { Insertion.sort(a, lo, hi); return; }
```

The optimum value of the cutoff `M` is system-dependent, but any value between 5 and 15 is likely to work well in most situations (see EXERCISE 2.3.25).

Median-of-three partitioning. A second easy way to improve the performance of quicksort is to use the median of a small sample of items taken from the subarray as the partitioning item. Doing so will give a slightly better partition, but at the cost of computing the median. It turns out that most of the available improvement comes from choosing a sample of size 3 and then partitioning on the middle item (see EXERCISES 2.3.18 and 2.3.19). As a bonus, we can use the sample items as sentinels at the ends of the array and remove both array bounds tests in `partition()`.

Entropy-optimal sorting. Arrays with large numbers of duplicate keys arise frequently in applications. For example, we might wish to sort a large personnel file by year of birth, or perhaps to separate females from males. In such situations, the quicksort implementation that we have considered has acceptable performance, but it can be substantially improved. For example, a subarray that consists solely of items that are equal (just one key value) does not need to be processed further, but our implementation keeps partitioning down to small subarrays. In a situation where there are large numbers of duplicate keys in the input array, the recursive nature of quicksort ensures that subarrays consisting solely of items with keys that are equal will occur often. There is potential for significant improvement, from the linearithmic-time performance of the implementations seen so far to linear-time performance.

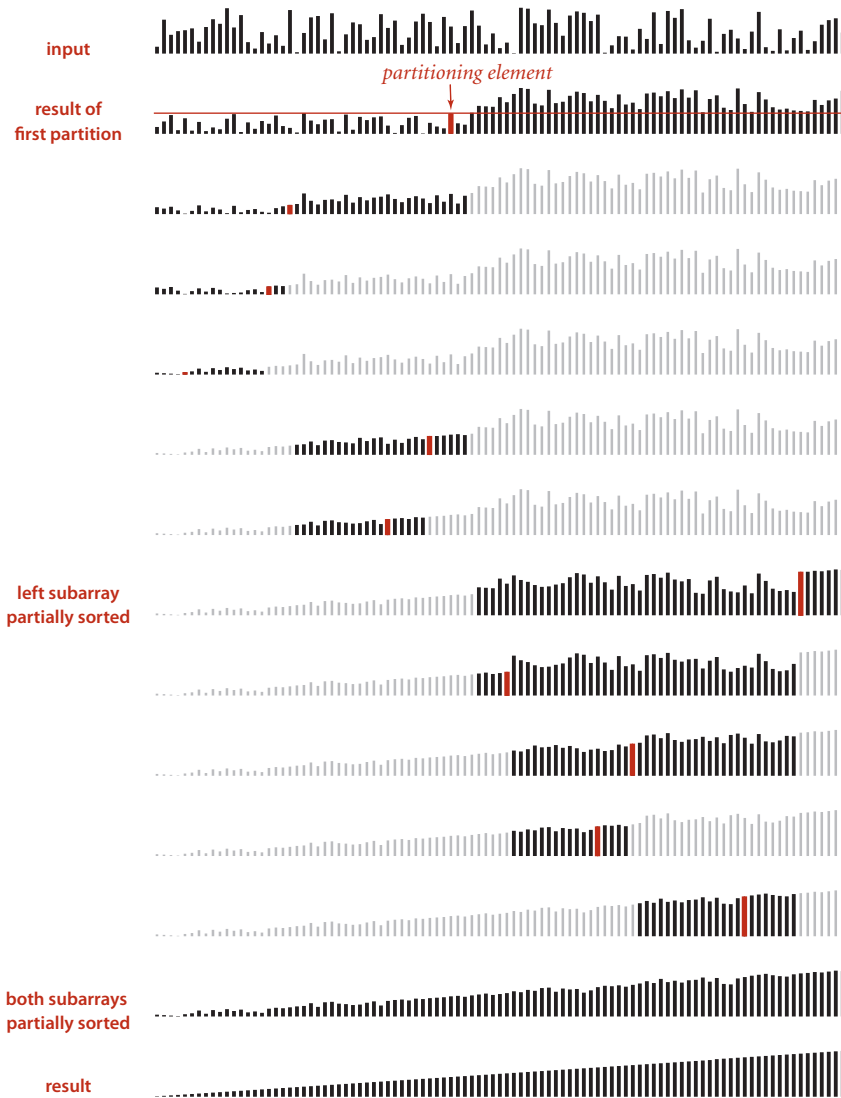

Quicksort with median-of-3 partitioning and cutoff for small subarrays

One straightforward idea is to partition the array into *three* parts, one each for items with keys smaller than, equal to, and larger than the partitioning item's key. Accomplishing this partitioning is more complicated than the 2-way partitioning that we have been using, and various different methods have been suggested for the task. It was a classical programming exercise popularized by E. W. Dijkstra as the *Dutch National Flag* problem, because it is like sorting an array with three possible key values, which might correspond to the three colors on the flag.

Dijkstra's solution to this problem leads to the remarkably simple partition code shown on the next page. It is based on a single left-to-right pass through the array that maintains a pointer `lt` such that `a[lo..lt-1]` is *less than* `v`, a pointer `gt` such that `a[gt+1..hi]` is *greater than* `v`, and a pointer `i` such that `a[lt..i-1]` are *equal to* `v` and `a[i..gt]` are not yet examined. Starting with `i` equal to `lo`, we process `a[i]` using the 3-way comparison given us by the `Comparable` interface (instead of using `less()`) to directly handle the three possible cases:

- `a[i]` less than `v`: exchange `a[lt]` with `a[i]` and increment both `lt` and `i`
- `a[i]` greater than `v`: exchange `a[i]` with `a[gt]` and decrement `gt`
- `a[i]` equal to `v`: increment `i`

Each of these operations both maintains the invariant and decreases the value of `gt-i` (so that the loop terminates). Furthermore, every item encountered leads to an exchange *except* for those items with keys equal to the partitioning item's key.

Though this code was developed not long after quicksort in the 1970s, it fell out of favor because it uses many more exchanges than the standard 2-way partitioning method for the common case when the number of duplicate keys in the array is not high. In the 1990s J. Bentley and D. McIlroy developed a clever implementation that overcomes this problem (see EXERCISE 2.3.22), and observed that 3-way partitioning makes quicksort asymptotically faster than mergesort and other methods in practical situations involving large numbers of equal keys. Later, J. Bentley and R. Sedgewick developed a proof of this fact, which we discuss next.

But we proved that mergesort is optimal. How have we defeated that lower bound? The answer to this question is that PROPOSITION 1 in SECTION 2.2 addresses worst-case performance over all possible inputs, while now we are looking at worst-case performance with some information about the key values at hand. Mergesort does not guarantee optimal performance for any given distribution of duplicates in the input:

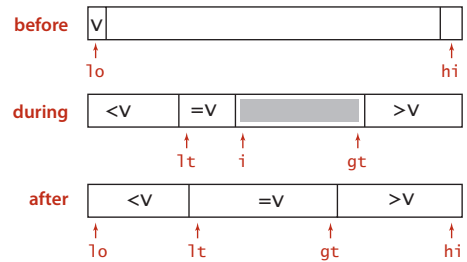

3-way partitioning overview

Quicksort with 3-way partitioning

```

public class Quick3way
{
    private static void sort(Comparable[] a, int lo, int hi)
    { // See page 289 for public sort() that calls this method.
      if (hi <= lo) return;
      int lt = lo, i = lo+1, gt = hi;
      Comparable v = a[lo];
      while (i <= gt)
      {
          int cmp = a[i].compareTo(v);
          if (cmp < 0)  exch(a, lt++, i++);
          else if (cmp > 0) exch(a, i, gt--);
          else          i++;
      } // Now a[lo..lt-1] < v = a[lt..gt] < a[gt+1..hi].
      sort(a, lo, lt - 1);
      sort(a, gt + 1, hi);
    }
}

```

This sort code partitions to put keys equal to the partitioning element in place and thus does not have to include those keys in the subarrays for the recursive calls. It is far more efficient than the standard quicksort implementation for arrays with large numbers of duplicate keys (see text).

lt	i	gt	a[]											
			0	1	2	3	4	5	6	7	8	9	10	11
0	0	11	R	B	W	W	R	W	B	R	R	W	B	R
0	1	11	R	B	W	W	R	W	B	R	R	W	B	R
1	2	11	B	R	W	W	R	W	B	R	R	W	B	R
1	2	10	B	R	R	W	R	W	B	R	R	W	B	W
1	3	10	B	R	R	W	R	W	B	R	R	W	B	W
1	3	9	B	R	R	B	R	W	B	R	R	W	W	W
2	4	9	B	B	R	R	R	W	B	R	R	W	W	W
2	5	9	B	B	R	R	R	W	B	R	R	W	W	W
2	5	8	B	B	R	R	R	W	B	R	R	W	W	W
2	5	7	B	B	R	R	R	R	B	R	R	W	W	W
2	6	7	B	B	R	R	R	R	B	R	R	W	W	W
3	7	7	B	B	B	R	R	R	R	R	R	W	W	W
3	8	7	B	B	B	R	R	R	R	R	R	W	W	W
3	8	7	B	B	B	R	R	R	R	R	R	W	W	W

3-way partitioning trace (array contents after each loop iteration)

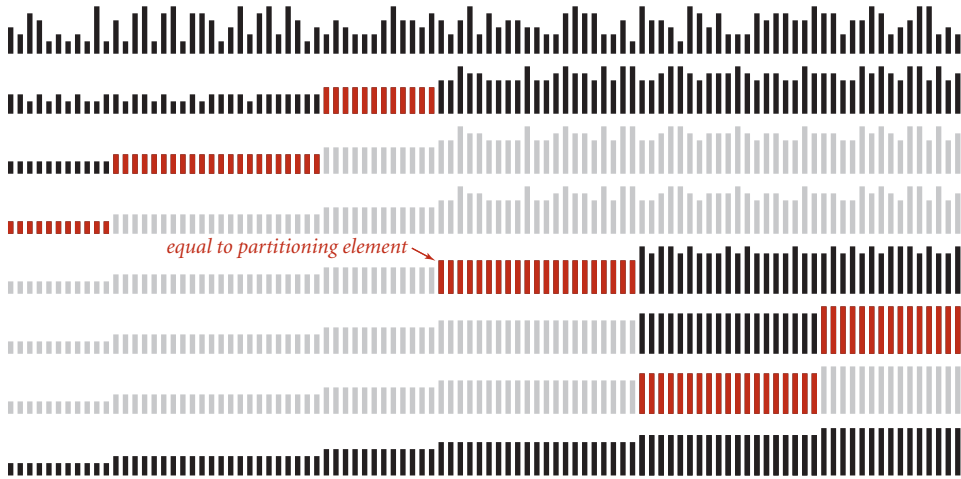

Visual trace of quicksort with 3-way partitioning

for example, mergesort is linearithmic for a randomly ordered array that has only a constant number of distinct key values, but quicksort with 3-way partitioning is linear for such an array. Indeed, by examining the visual trace above, you can see that N times the number of key values is a conservative bound on the running time.

The analysis that makes these notions precise takes the distribution of key values into account. Given N keys with k distinct key values, for each i from 1 to k define f_i to be frequency of occurrence of the i th key value and p_i to be f_i / N , the probability that the i th key value is found when a random entry of the array is sampled. The *Shannon entropy* of the keys (a classic measure of their information content) is defined as

$$H = -(p_1 \lg p_1 + p_2 \lg p_2 + \dots + p_k \lg p_k)$$

Given any array of items to be sorted, we can calculate its entropy by counting the frequency of each key value. Remarkably, we can also derive from the entropy both a lower bound on the number of compares and an upper bound on the number of compares used by quicksort with 3-way partitioning.

Proposition M. No compare-based sorting algorithm can guarantee to sort N items with fewer than $NH - N$ compares, where H is the Shannon entropy, defined from the frequencies of key values.

Proof sketch: This result follows from a (relatively easy) generalization of the lower bound proof of PROPOSITION I in SECTION 2.2.

Proposition N. Quicksort with 3-way partitioning uses $\sim (2 \ln 2) NH$ compares to sort N items, where H is the Shannon entropy, defined from the frequencies of key values.

Proof sketch: This result follows from a (relatively difficult) generalization of the average-case analysis of quicksort in PROPOSITION K. As with distinct keys, this costs about 39 percent more than the optimum (but within a constant factor).

Note that $H = \lg N$ when the keys are all distinct (all the probabilities are $1/N$), which is consistent with PROPOSITION I in SECTION 2.2 and PROPOSITION K. The worst case for 3-way partitioning happens when the keys are distinct; when duplicate keys are present, it can do much better than mergesort. More important, these two properties together imply that quicksort with 3-way partitioning is *entropy-optimal*, in the sense that the average number of compares used by the best possible compare-based sorting algorithm and the average number of compares used by 3-way quicksort are within a constant factor of one another, for any given distribution of input key values.

As with standard quicksort, the running time tends to the average as the array size grows, and large deviations from the average are extremely unlikely, so that you can depend on 3-way quicksort's running time to be proportional to N times the entropy of the distribution of input key values. This property of the algorithm is important in practice because *it reduces the time of the sort from linearithmic to linear for arrays with large numbers of duplicate keys*. The order of the keys is immaterial, because the algorithm shuffles them to protect against the worst case. The distribution of keys defines the entropy and no compare-based algorithm can use fewer compares than defined by the entropy. This ability to adapt to duplicates in the input makes 3-way quicksort the algorithm of choice for a library sort—clients that sort arrays containing large numbers of duplicate keys are not unusual.

A CAREFULLY TUNED VERSION of quicksort is likely to run significantly faster on most computers for most applications than will any other compare-based sorting method. Quicksort is widely used throughout today's computational infrastructure because the mathematical models that we have discussed suggest that it will outperform other methods in practical applications, and extensive experiments and experience over the past several decades have validated that conclusion.

We will see in CHAPTER 5 that this is not quite the end of the story in the development of sorting algorithms, because is it possible to develop algorithms that do not use compares at all! But a version of quicksort turns out to be best in that situation, as well.

Q & A

Q. Is there some way to just divide the array into two halves, rather than letting the partitioning element fall where it may?

A. That is a question that stumped experts for over a decade. It is tantamount to finding the *median* key value in the array and then partitioning on that value. We discuss the problem of finding the median on page 346. It is possible to do so in linear time, but the cost of doing so with known algorithms (which are based on quicksort partitioning!) far exceeds the 39 percent savings available from splitting the array into equal parts.

Q. Randomly shuffling the array seems to take a significant fraction of the total time for the sort. Is doing so really worthwhile?

A. Yes. It protects against the worst case and makes the running time predictable. Hoare proposed this approach when he presented the algorithm in 1960—it is a prototypical (and among the first) randomized algorithm.

Q. Why all the focus on items with equal keys?

A. The issue directly impacts performance in practical situations. It was overlooked by many for decades, with the result that some older implementations of quicksort take quadratic time for arrays with large numbers of items with equal keys, which certainly do arise in applications. Better implementations such as ALGORITHM 2.5 take linearithmic time for such arrays, but improving that to linear-time as in the entropy-optimal sort at the end of this section is worthwhile in many situations.

EXERCISES

2.3.1 Show, in the style of the trace given with `partition()`, how that method partitions the array `E A S Y Q U E S T I O N`.

2.3.2 Show, in the style of the quicksort trace given in this section, how quicksort sorts the array `E A S Y Q U E S T I O N` (for the purposes of this exercise, ignore the initial shuffle).

2.3.3 What is the maximum number of times during the execution of `Quick.sort()` that the largest item can be exchanged, for an array of length N ?

2.3.4 Suppose that the initial random shuffle is omitted. Give six arrays of ten elements for which `Quick.sort()` uses the worst-case number of compares.

2.3.5 Give a code fragment that sorts an array that is known to consist of items having just two distinct keys.

2.3.6 Write a program to compute the exact value of C_N , and compare the exact value with the approximation $2N \ln N$, for $N = 100, 1,000, \text{ and } 10,000$.

2.3.7 Find the expected number of subarrays of size 0, 1, and 2 when quicksort is used to sort an array of N items with distinct keys. If you are mathematically inclined, do the math; if not, run some experiments to develop hypotheses.

2.3.8 About how many compares will `Quick.sort()` make when sorting an array of N items that are all equal?

2.3.9 Explain what happens when `Quick.sort()` is run on an array having items with just two distinct keys, and then explain what happens when it is run on an array having just three distinct keys.

2.3.10 *Chebyshev's inequality* says that the probability that a random variable is more than k standard deviations away from the mean is less than $1/k^2$. For $N = 1$ million, use Chebyshev's inequality to bound the probability that the number of compares used by quicksort is more than 100 billion ($.1 N^2$).

2.3.11 Suppose that we scan over items with keys equal to the partitioning item's key instead of stopping the scans when we encounter them. Show that the running time of this version of quicksort is quadratic for all arrays with just a constant number of distinct keys.

EXERCISES *(continued)*

2.3.12 Show, in the style of the trace given with the code, how the entropy-optimal sort first partitions the array B A B A B A B A C A D A B R A.

2.3.13 What is the *recursive depth* of quicksort, in the best, worst, and average cases? This is the size of the stack that the system needs to keep track of the recursive calls. See EXERCISE 2.3.20 for a way to guarantee that the recursive depth is logarithmic in the worst case.

2.3.14 Prove that when running quicksort on an array with N distinct items, the probability of comparing the i th and j th largest items is $2/(j - i)$. Then use this result to prove PROPOSITION K.

CREATIVE PROBLEMS

2.3.15 *Nuts and bolts.* (G. J. E. Rawlins) You have a mixed pile of N nuts and N bolts and need to quickly find the corresponding pairs of nuts and bolts. Each nut matches exactly one bolt, and each bolt matches exactly one nut. By fitting a nut and bolt together, you can see which is bigger, but it is not possible to directly compare two nuts or two bolts. Give an efficient method for solving the problem.

2.3.16 *Best case.* Write a program that produces a best-case array (with no duplicates) for `sort()` in ALGORITHM 2.5: an array of N items with distinct keys having the property that every partition will produce subarrays that differ in size by at most 1 (the same subarray sizes that would happen for an array of N equal keys). (For the purposes of this exercise, ignore the initial shuffle.)

The following exercises describe variants of quicksort. Each of them calls for an implementation, but naturally you will also want to use `SortCompare` for experiments to evaluate the effectiveness of each suggested modification.

2.3.17 *Sentinels.* Modify the code in ALGORITHM 2.5 to remove both bounds checks in the inner `while` loops. The test against the left end of the subarray is redundant since the partitioning item acts as a sentinel (v is never less than $a[l_0]$). To enable removal of the other test, put an item whose key is the largest in the whole array into $a[\text{length}-1]$ just after the shuffle. This item will never move (except possibly to be swapped with an item having the same key) and will serve as a sentinel in all subarrays involving the end of the array. *Note:* When sorting interior subarrays, the leftmost entry in the subarray to the right serves as a sentinel for the right end of the subarray.

2.3.18 *Median-of-3 partitioning.* Add median-of-3 partitioning to quicksort, as described in the text (see page 296). Run doubling tests to determine the effectiveness of the change.

2.3.19 *Median-of-5 partitioning.* Implement a quicksort based on partitioning on the median of a random sample of five items from the subarray. Put the items of the sample at the appropriate ends of the array so that only the median participates in partitioning. Run doubling tests to determine the effectiveness of the change, in comparison both to the standard algorithm and to median-of-3 partitioning (see the previous exercise). *Extra credit:* Devise a median-of-5 algorithm that uses fewer than seven compares on any input.

CREATIVE PROBLEMS *(continued)*

2.3.20 *Nonrecursive quicksort.* Implement a nonrecursive version of quicksort based on a main loop where a subarray is popped from a stack to be partitioned, and the resulting subarrays are pushed onto the stack. *Note:* Push the larger of the subarrays onto the stack first, which guarantees that the stack will have at most $\lg N$ entries.

2.3.21 *Lower bound for sorting with equal keys.* Complete the first part of the proof of PROPOSITION M by following the logic in the proof of PROPOSITION I and using the observation that there are $N! / f_1! f_2! \dots f_k!$ different ways to arrange keys with k different values, where the i th value appears with frequency $f_i (= Np_i$, in the notation of PROPOSITION M), with $f_1 + \dots + f_k = N$.

2.3.22 *Fast 3-way partitioning.* (J. Bentley and D. McIlroy) Implement an entropy-optimal sort based on keeping item's with equal keys at both the left and right ends

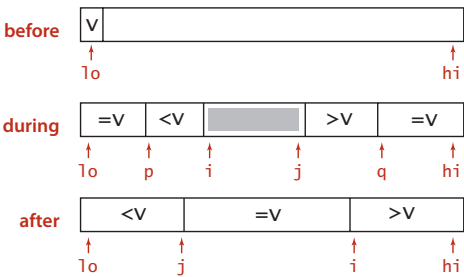

Bentley-McIlroy 3-way partitioning

Note: This code complements the code given in the text, in the sense that it does extra swaps for keys equal to the partitioning item's key, while the code in the text does extra swaps for keys that are *not* equal to the partitioning item's key.

2.3.23 *Java system sort.* Add to your implementation from EXERCISE 2.3.22 code to use the *Tukey ninther* to compute the partitioning item—choose three sets of three items, take the median of each, then use the median of the three medians as the partitioning item. Also, add a cutoff to insertion sort for small subarrays.

2.3.24 *Samplesort.* (W. Frazer and A. McKellar) Implement a quicksort based on using a sample of size $2^k - 1$. First, sort the sample, then arrange to have the recursive routine partition on the median of the sample and to move the two halves of the rest of the sample to each subarray, such that they can be used in the subarrays, without having to be sorted again. This algorithm is called *samplesort*.

EXPERIMENTS

2.3.25 *Cutoff to insertion sort.* Implement quicksort with a cutoff to insertion sort for subarrays with less than M elements, and empirically determine the value of M for which quicksort runs fastest in your computing environment to sort random arrays of N doubles, for $N = 10^3, 10^4, 10^5$, and 10^6 . Plot average running times for M from 0 to 30 for each value of M . *Note:* You need to add a three-argument `sort()` method to ALGORITHM 2.2 for sorting subarrays such that the call `Insertion.sort(a, lo, hi)` sorts the subarray `a[lo..hi]`.

2.3.26 *Subarray sizes.* Write a program that plots a histogram of the subarray sizes left for insertion sort when you run quicksort for an array of size N with a cutoff for subarrays of size less than M . Run your program for $M=10, 20$, and 50 and $N = 10^5$.

2.3.27 *Ignore small subarrays.* Run experiments to compare the following strategy for dealing with small subarrays with the approach described in EXERCISE 2.3.25: Simply ignore the small subarrays in quicksort, then run a single insertion sort after the quicksort completes. *Note:* You may be able to estimate the size of your computer's cache memory with these experiments, as the performance of this method is likely to degrade when the array does not fit in the cache.

2.3.28 *Recursion depth.* Run empirical studies to determine the average recursive depth used by quicksort with cutoff for arrays of size M , when sorting arrays of N distinct elements, for $M=10, 20$, and 50 and $N = 10^3, 10^4, 10^5$, and 10^6 .

2.3.29 *Randomization.* Run empirical studies to compare the effectiveness of the strategy of choosing a random partitioning item with the strategy of initially randomizing the array (as in the text). Use a cutoff for arrays of size M , and sort arrays of N distinct elements, for $M=10, 20$, and 50 and $N = 10^3, 10^4, 10^5$, and 10^6 .

2.3.30 *Corner cases.* Test quicksort on large nonrandom arrays of the kind described in EXERCISES 2.1.35 and 2.1.36 both with and without the initial random shuffle. How does shuffling affect its performance for these arrays?

2.3.31 *Histogram of running times.* Write a program that takes command-line arguments N and T , does T trials of the experiment of running quicksort on an array of N random `Double` values, and plots a histogram of the observed running times. Run your program for $N = 10^3, 10^4, 10^5$, and 10^6 , with T as large as you can afford to make the curves smooth. Your main challenge for this exercise is to appropriately scale the experimental results.



2.4 PRIORITY QUEUES

MANY APPLICATIONS REQUIRE that we process items having keys in order, but not necessarily in full sorted order and not necessarily all at once. Often, we collect a set of items, then process the one with the largest key, then perhaps collect more items, then process the one with the current largest key, and so forth. For example, you are likely to have a computer (or a cellphone) that is capable of running several applications at the same time. This effect is typically achieved by assigning a priority to events associated with applications, then always choosing to process next the highest-priority event. For example, most cellphones are likely to process an incoming call with higher priority than a game application.

An appropriate data type in such an environment supports two operations: *remove the maximum* and *insert*. Such a data type is called a *priority queue*. Using priority queues is similar to using queues (remove the oldest) and stacks (remove the newest), but implementing them efficiently is more challenging.

In this section, after a short discussion of elementary representations where one or both of the operations take linear time, we consider a classic priority-queue implementation based on the *binary heap* data structure, where items are kept in an array, subject to certain ordering constraints that allow for efficient (logarithmic-time) implementations of *remove the maximum* and *insert*.

Some important applications of priority queues include simulation systems, where the keys correspond to event times, to be processed in chronological order; job scheduling, where the keys correspond to priorities indicating which tasks are to be performed first; and numerical computations, where the keys represent computational errors, indicating in which order we should deal with them. We consider in CHAPTER 6 a detailed case study showing the use of priority queues in a particle-collision simulation.

We can use any priority queue as the basis for a sorting algorithm by inserting a sequence of items, then successively removing the smallest to get them out, in order. An important sorting algorithm known as *heapsort* also follows naturally from our heap-based priority-queue implementations. Later on in this book, we shall see how to use priority queues as building blocks for other algorithms. In CHAPTER 4, we shall see how priority queues are an appropriate abstraction for implementing several fundamental graph-searching algorithms; in CHAPTER 5, we shall develop a data-compression algorithm using methods from this section. These are but a few examples of the important role played by the priority queue as a tool in algorithm design.

API The priority queue is a prototypical *abstract data type* (see SECTION 1.2): it represents a set of values and operations on those values, and it provides a convenient abstraction that allows us to separate application programs (clients) from various implementations that we will consider in this section. As in SECTION 1.2, we precisely define the operations by specifying an applications programming interface (API) that provides the information needed by clients. Priority queues are characterized by the *remove the maximum* and *insert* operations, so we shall focus on them. We use the method names `delMax()` for *remove the maximum* and `insert()` for *insert*. By convention, we will compare keys only with a helper `less()` method, as we have been doing for sorting. Thus, if items can have duplicate keys, *maximum* means *any* item with the largest key value. To complete the API, we also need to add constructors (like the ones we used for stacks and queues) and a *test if empty* operation. For flexibility, we use a generic implementation with a parameterized type `Key` that implements the `Comparable` interface. This choice eliminates our distinction between items and keys and enables clearer and more compact descriptions of data structures and algorithms. For example, we refer to the “largest key” instead of the “largest item” or the “item with the largest key.”

For convenience in client code, the API includes three constructors, which enable clients to build priority queues of an initial fixed size (perhaps initialized with a given array of keys). To clarify client code, we will use a separate class `MinPQ` whenever appropriate, which is the same as `MaxPQ` except that it has a `delMin()` method that deletes and returns an item with the smallest key in the queue. Any `MaxPQ` implementation is easily converted into a `MinPQ` implementation and vice versa, simply by reversing the sense of the comparison in `less()`.

```
public class MaxPQ<Key extends Comparable<Key>>
```

<code>MaxPQ()</code>	<i>create a priority queue</i>
<code>MaxPQ(int max)</code>	<i>create a priority queue of initial capacity max</i>
<code>MaxPQ(Key[] a)</code>	<i>create a priority queue from the keys in a[]</i>
<code>void insert(Key v)</code>	<i>insert a key into the priority queue</i>
<code>Key max()</code>	<i>return the largest key</i>
<code>Key delMax()</code>	<i>return and remove the largest key</i>
<code>boolean isEmpty()</code>	<i>is the priority queue empty?</i>
<code>int size()</code>	<i>number of keys in the priority queue</i>

API for a generic priority queue

A priority-queue client. To appreciate the value of the priority-queue abstraction, consider the following problem: You have a huge input stream of N strings and associated integer values, and your task is to find the largest or smallest M integers (and associated strings) in the input stream. You might imagine the stream to be financial transactions, where your interest is to find the big ones, or pesticide levels in an agricultural product, where your interest is to find the small ones, or requests for service, or results from a scientific experiment, or whatever. In some applications, the size of the input stream is so huge that it is best to consider it to be unbounded. One way to address this problem would be to sort the input stream and take the M largest keys from the result, but we have just stipulated that the input stream is too large for that. Another approach would be to compare each new key against the M largest seen so far, but that is also likely to be prohibitively expensive unless M is small. With priority queues, we can solve the problem with the `MinPQ` client `TopM` on the next page *provided* that we can develop efficient implementations of both `insert()` and `deMin()`. That is precisely our aim in this section. For the huge values of N that are likely to be encountered in our modern computational infrastructure, these implementations can make the difference between being able to address such a problem and not having the resources to do it at all.

client	order of growth	
	time	space
<i>sort client</i>	$N \log N$	N
<i>PQ client using elementary implementation</i>	NM	M
<i>PQ client using heap-based implementation</i>	$N \log M$	M

Costs of finding the largest M in a stream of N items

Elementary implementations The basic data structures that we discussed in CHAPTER 1 provide us with four immediate starting points for implementing priority queues. We can use an array or a linked list, kept in order or unordered. These implementations are useful for small priority queues, situations where one of the two operations are predominant, or situations where some assumptions can be made about the order of the keys involved in the operations. Since these implementations are elementary, we will be content with brief descriptions here in the text and leave the code for exercises (see EXERCISE 2.4.3).

Array representation (unordered). Perhaps the simplest priority-queue implementation is based on our code for pushdown stacks in SECTION 2.1. The code for *insert* in the priority queue is the same as for *push* in the stack. To implement *remove the maximum*, we can add code like the inner loop of selection sort to exchange the maximum item with the item at the end and then delete that one, as we did with `pop()` for stacks. As with stacks, we can add resizing-array code to ensure that the data structure is always at least one-quarter full and never overflows.

A priority-queue client

```

public class TopM
{
    public static void main(String[] args)
    { // Print the top M lines in the input stream.
        int M = Integer.parseInt(args[0]);
        MinPQ<Transaction> pq = new MinPQ<Transaction>(M+1);
        while (StdIn.hasNextLine())
        { // Create an entry from the next line and put on the PQ.
            pq.insert(new Transaction(StdIn.readLine()));
            if (pq.size() > M)
                pq.delMin(); // Remove minimum if M+1 entries on the PQ.
        } // Top M entries are on the PQ.

        Stack<Transaction> stack = new Stack<Transaction>();
        while (!pq.isEmpty()) stack.push(pq.delMin());
        for (Transaction t : stack) StdOut.println(t);
    }
}

```

Given an integer M from the command line and an input stream where each line contains a transaction, this `MinPQ` client prints the M lines whose numbers are the highest. It does so by using our `Transaction` class (see page 79, EXERCISE 1.2.19, and EXERCISE 2.1.21) to build a priority queue using

the numbers as keys, deleting the minimum after each insertion once the size of the priority queue reaches M . Once all the transactions have been processed, the top M come off the priority queue in increasing order, so this code puts them on a stack, then iterates through the stack to reverse the order and print them in increasing order.

```

% more tinyBatch.txt
Turing      6/17/1990    644.08
vonNeumann  3/26/2002   4121.85
Dijkstra    8/22/2007   2678.40
vonNeumann  1/11/1999   4409.74
Dijkstra    11/18/1995   837.42
Hoare       5/10/1993   3229.27
vonNeumann  2/12/1994   4732.35
Hoare       8/18/1992   4381.21
Turing      1/11/2002    66.10
Thompson    2/27/2000   4747.08
Turing      2/11/1991   2156.86
Hoare       8/12/2003   1025.70
vonNeumann  10/13/1993  2520.97
Dijkstra    9/10/2000   708.95
Turing      10/12/1993  3532.36
Hoare       2/10/2005   4050.20

```

```

% java TopM 5 < tinyBatch.txt
Thompson    2/27/2000   4747.08
vonNeumann  2/12/1994   4732.35
vonNeumann  1/11/1999   4409.74
Hoare       8/18/1992   4381.21
vonNeumann  3/26/2002   4121.85

```

Array representation (ordered). Another approach is to add code for *insert* to move larger entries one position to the right, thus keeping the keys in the array in order (as in insertion sort). Thus, the largest element is always at the end, and the code for *remove the maximum* in the priority queue is the same as for *pop* in the stack.

Linked-list representations. Similarly, we can start with our linked-list code for push-down stacks, modifying either the code for *pop()* to find and return the maximum or the code for *push()* to keep keys in *reverse* order and the code for *pop()* to unlink and return the first (maximum) item on the list.

data structure	insert	remove maximum
<i>ordered array</i>	N	1
<i>unordered array</i>	1	N
<i>heap</i>	$\log N$	$\log N$
<i>impossible</i>	1	1

Order of growth of worst-case running time for priority-queue implementations

Using unordered sequences is the prototypical *lazy* approach to this problem, where we defer doing work until necessary (to find the maximum); using ordered sequences is the prototypical *eager* approach to the problem, where we do as much work as we can up front (keep the list sorted on insertion) to make later operations efficient.

The significant difference between implementing stacks or queues and implementing priority queues has to do with performance. For stacks and queues, we were able to develop implementations of all the operations that take *constant* time; for priority queues, all of the elementary implementations just discussed have the property that either the *insert* or the *remove the maximum* operation takes *linear* time in the worst case. The *heap* data structure that we consider next enables implementations where *both* operations are guaranteed to be fast.

operation	argument	return value	size	contents (unordered)	contents (ordered)
<i>insert</i>	P		1	P	P
<i>insert</i>	Q		2	P Q	P Q
<i>insert</i>	E		3	P Q E	E P Q
<i>remove max</i>		Q	2	P E	E P
<i>insert</i>	X		3	P E X	E P X
<i>insert</i>	A		4	P E X A	A E P X
<i>insert</i>	M		5	P E X A M	A E M P X
<i>remove max</i>		X	4	P E M A	A E M P
<i>insert</i>	P		5	P E M A P	A E M P P
<i>insert</i>	L		6	P E M A P L	A E L M P
<i>insert</i>	E		7	P E M A P L E	A E E L M
<i>remove max</i>		P	6	E E M A P L	A E E L M

A sequence of operations on a priority queue

Heap definitions The *binary heap* is a data structure that can efficiently support the basic priority-queue operations. In a binary heap, the keys are stored in an array such that each key is guaranteed to be larger than (or equal to) the keys at two other specific positions. In turn, each of those keys must be larger than (or equal to) two additional keys, and so forth. This ordering is easy to see if we view the keys as being in a binary tree structure with edges from each key to the two keys known to be smaller.

Definition. A binary tree is *heap-ordered* if the key in each node is larger than or equal to the keys in that node's two children (if any).

Equivalently, the key in each node of a heap-ordered binary tree is smaller than or equal to the key in that node's parent (if any). Moving up from any node, we get a nondecreasing sequence of keys; moving down from any node, we get a nonincreasing sequence of keys. In particular:

Proposition O. The largest key in a heap-ordered binary tree is found at the root.

Proof: By induction on the size of the tree.

Binary heap representation. If we use a linked representation for heap-ordered binary trees, we would need to have three links associated with each key to allow travel up and down the tree (each node would have one pointer to its parent and one to each child). It is particularly convenient, instead, to use a *complete* binary tree like the one drawn at right. We draw such a structure by placing the root node and then proceeding down the page and from left to right, drawing and connecting two nodes beneath each node on the previous level until we have drawn N nodes. Complete trees provide the opportunity to use a compact array representation that does not involve explicit links. Specifically, we represent complete binary trees sequentially within an array by putting the nodes in *level order*, with the root at position 1, its children at positions 2 and 3, their children in positions 4, 5, 6, and 7, and so on.

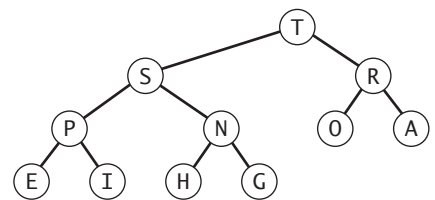

A heap-ordered complete binary tree

Definition. A *binary heap* is a collection of keys arranged in a complete heap-ordered binary tree, represented in level order in an array (not using the first entry).

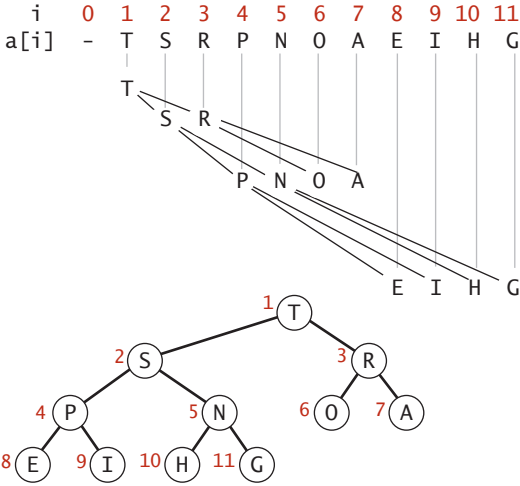

Heap representations

(For brevity, from now on we drop the “binary” modifier and use the term *heap* when referring to a binary heap.) In a heap, the parent of the node in position k is in position $\lfloor k/2 \rfloor$ and, conversely, the two children of the node in position k are in positions $2k$ and $2k + 1$. Instead of using explicit links (as in the binary tree structures that we will consider in CHAPTER 3), we can travel up and down by doing simple arithmetic on array indices: to move *up* the tree from $a[k]$ we set k to $k/2$; to move *down* the tree we set k to $2*k$ or $2*k+1$.

Complete binary trees represented as arrays (heaps) are rigid structures, but they have just enough flexibility to allow us to implement efficient priority-queue operations. Specifically, we

will use them to develop logarithmic-time *insert* and *remove the maximum* implementations. These algorithms take advantage of the capability to move up and down paths in the tree without pointers and have guaranteed logarithmic performance because of the following property of complete binary trees:

Proposition P. The height of a complete binary tree of size N is $\lfloor \lg N \rfloor$.

Proof: The stated result is easy to prove by induction or by noting that the height increases by 1 when N is a power of 2.

Algorithms on heaps We represent a heap of size N in private array `pq[]` of length $N + 1$, with `pq[0]` unused and the heap in `pq[1]` through `pq[N]`. As for sorting algorithms, we access keys only through private helper functions `less()` and `exch()`, but since all items are in the instance variable `pq[]`, we use the more compact implementations on the next page that do not involve passing the array name as a parameter. The heap operations that we consider work by first making a simple modification that could violate the heap condition, then traveling through the heap, modifying the heap as required to ensure that the heap condition is satisfied everywhere. We refer to this process as *reheapifying*, or *restoring heap order*.

```
private boolean less(int i, int j)
{ return pq[i].compareTo(pq[j]) < 0; }

private void exch(int i, int j)
{ Key t = pq[i]; pq[i] = pq[j]; pq[j] = t; }
```

Compare and exchange methods for heap implementations

There are two cases. When the priority of some node is increased (or a new node is added at the bottom of a heap), we have to travel *up* the heap to restore the heap order. When the priority of some node is decreased (for example, if we replace the node at the root with a new node that has a smaller key), we have to travel *down* the heap to restore the heap order. First, we will consider how to implement these two basic auxiliary operations; then, we shall see how to use them to implement *insert* and *remove the maximum*.

Bottom-up reheapify (swim). If the heap order is violated because a node's key becomes *larger* than that node's parent's key, then we can make progress toward fixing the violation by exchanging the node with its parent.

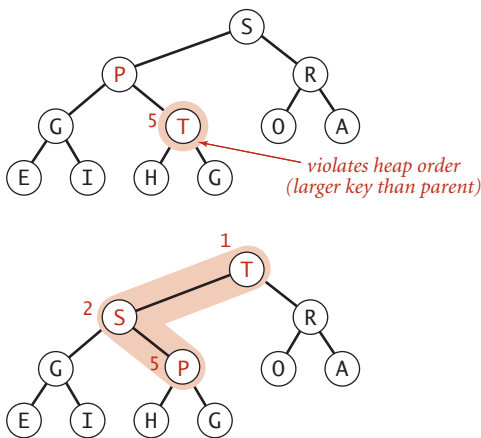

Bottom-up reheapify (swim)

After the exchange, the node is larger than both its children (one is the old parent, and the other is smaller than the old parent because it was a child of that node) but the node may still be larger than its parent. We can fix that violation in the same way, and so forth, moving up the heap until we reach a node with a larger key, or the root. Coding this process is straightforward when you keep in mind that the parent of the node at position k in a heap is at position $k/2$. The loop in `swim()` preserves the invariant that the only place the heap

order could be violated is when the node at position k might be larger than its parent. Therefore, when we get to a place where that node is not larger than its parent, we know that the heap order is satisfied throughout the heap. To justify the method's name, we think of the new node, having too large a key, as having to *swim* to a higher level in the heap.

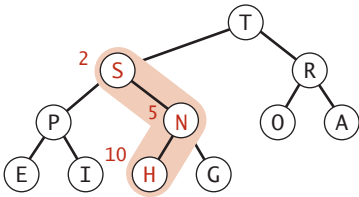
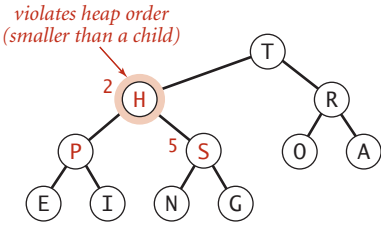

Top-down reheapify (sink)

the children of the node at position k in a heap are at positions $2k$ and $2k+1$. To justify the method's name, we think about the node, having too small a key, as having to *sink* to a lower level in the heap.

IF WE IMAGINE the heap to represent a cutthroat corporate hierarchy, with each of the children of a node representing subordinates (and the parent representing the immediate superior), then these operations have amusing interpretations. The `swim()` operation corresponds to a promising new manager arriving on the scene, being promoted up the chain of command (by exchanging jobs with any lower-qualified boss) until the new person encounters a higher-qualified boss. The `sink()` operation is analogous to the situation when the president of the company resigns and is replaced by someone from the outside. If the president's most powerful subordinate

```
private void swim(int k)
{
    while (k > 1 && less(k/2, k))
    {
        exch(k/2, k);
        k = k/2;
    }
}
```

Bottom-up reheapify (swim) implementation

Top-down reheapify (sink). If the heap order is violated because a node's key becomes *smaller* than one or both of that node's children's keys, then we can make progress toward fixing the violation by exchanging the node with the *larger* of its two children. This switch may cause a violation at the child; we fix that violation in the same way, and so forth, moving down the heap until we reach a node with both children smaller (or equal), or the bottom. The code again follows directly from

```
private void sink(int k)
{
    while (2*k <= N)
    {
        int j = 2*k;
        if (j < N && less(j, j+1)) j++;
        if (!less(k, j)) break;
        exch(k, j);
        k = j;
    }
}
```

Top-down reheapify (sink) implementation

is stronger than the new person, they exchange jobs, and we move down the chain of command, demoting the new person and promoting others until the level of competence of the new person is reached, where there is no higher-qualified subordinate. These idealized scenarios may rarely be seen in the real world, but they may help you better understand basic operation on heaps.

These `sink()` and `swim()` operations provide the basis for efficient implementation of the priority-queue API, as diagrammed below and implemented in ALGORITHM 2.6 on the next page.

Insert. We add the new key at the end of the array, increment the size of the heap, and then swim up through the heap with that key to restore the heap condition.

Remove the maximum. We take the largest key off the top, put the item from the end of the heap at the top, decrement the size of the heap, and then sink down through the heap with that key to restore the heap condition.

ALGORITHM 2.6 solves the basic problem that we posed at the beginning of this section: it is a priority-queue API implementation for which both *insert* and *delete the maximum* are guaranteed to take time logarithmic in the size of the queue.

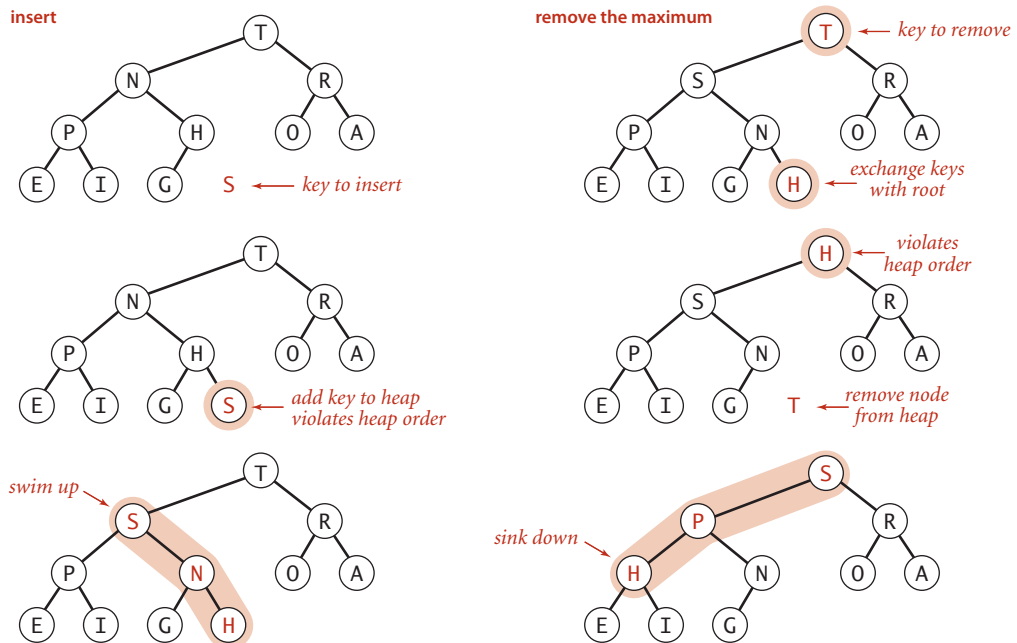

Heap operations

ALGORITHM 2.6 Heap priority queue

```

public class MaxPQ<Key extends Comparable<Key>>
{
    private Key[] pq;           // heap-ordered complete binary tree
    private int N = 0;         // in pq[1..N] with pq[0] unused

    public MaxPQ(int maxN)
    { pq = (Key[]) new Comparable[maxN+1]; }

    public boolean isEmpty()
    { return N == 0; }

    public int size()
    { return N; }

    public void insert(Key v)
    {
        pq[++N] = v;
        swim(N);
    }

    public Key delMax()
    {
        Key max = pq[1];           // Retrieve max key from top.
        exch(1, N--);           // Exchange with last item.
        pq[N+1] = null;         // Avoid loitering.
        sink(1);               // Restore heap property.
        return max;
    }

    // See pages 145-147 for implementations of these helper methods.
    private boolean less(int i, int j)
    private void exch(int i, int j)
    private void swim(int k)
    private void sink(int k)
}

```

The priority queue is maintained in a heap-ordered complete binary tree in the array `pq[]` with `pq[0]` unused and the `N` keys in the priority queue in `pq[1]` through `pq[N]`. To implement `insert()`, we increment `N`, add the new element at the end, then use `swim()` to restore the heap order. For `delMax()`, we take the value to be returned from `pq[1]`, then move `pq[N]` to `pq[1]`, decrement the size of the heap, and use `sink()` to restore the heap condition. We also set the now-unused position `pq[N+1]` to `null` to allow the system to reclaim the memory associated with it. Code for dynamic array resizing is omitted, as usual (see SECTION 1.3). See EXERCISE 2.4.19 for the other constructors.

Proposition Q. In an N -key priority queue, the heap algorithms require no more than $1 + \lg N$ compares for *insert* and no more than $2 \lg N$ compares for *remove the maximum*.

Proof: By PROPOSITION P, both operations involve moving along a path between the root and the bottom of the heap whose number of links is no more than $\lg N$. The *remove the maximum* operation requires two compares for each node on the path (except at the bottom): one to find the child with the larger key, the other to decide whether that child needs to be promoted.

For typical applications that require a large number of intermixed insert and remove the maximum operations in a large priority queue, PROPOSITION Q represents an important performance breakthrough, summarized in the table shown on page 312. Where elementary implementations using an ordered array or an unordered array require linear time for one of the operations, a heap-based implementation provides a guarantee that both operations complete in logarithmic time. This improvement can make the difference between solving a problem and not being able to address it at all.

Multiway heaps. It is not difficult to modify our code to build heaps based on an array representation of complete heap-ordered *ternary* trees, with an entry at position k larger than or equal to entries at positions $3k-1$, $3k$, and $3k+1$ and smaller than or equal to entries at position $\lfloor (k+1)/3 \rfloor$, for all indices between 1 and N in an array of N items, and not much more difficult to use d -ary heaps for any given d . There is a tradeoff between the lower cost from the reduced tree height ($\log_d N$) and the higher cost of finding the largest of the d children at each node. This tradeoff is dependent on details of the implementation and the expected relative frequency of operations.

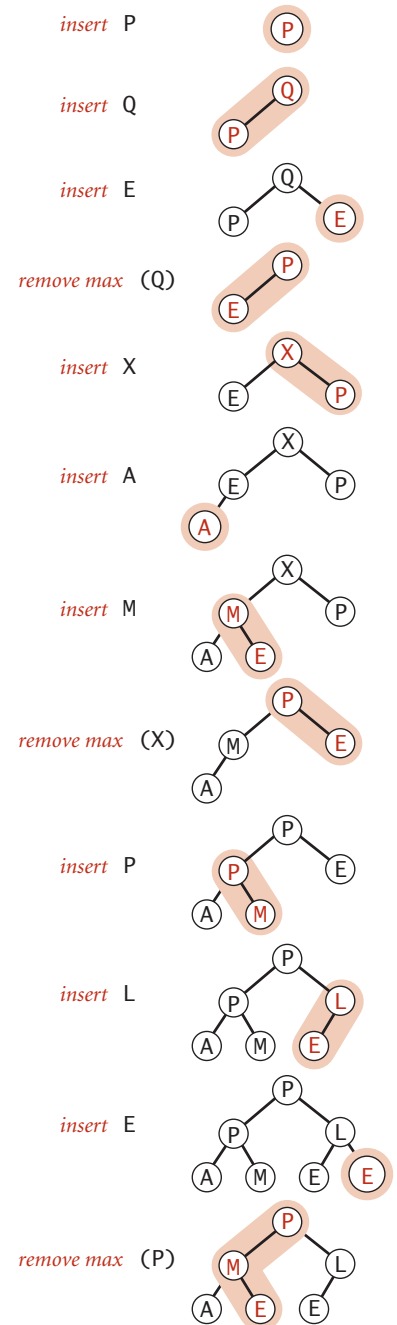

Priority queue operations in a heap

Array resizing. We can add a no-argument constructor, code for array doubling in `insert()`, and code for array halving in `delMax()`, just as we did for stacks in SECTION 1.3. Thus, clients need not be concerned about arbitrary size restrictions. The logarithmic time bounds implied by PROPOSITION Q are *amortized* when the size of the priority queue is arbitrary and the arrays are resized (see EXERCISE 2.4.22).

Immutability of keys. The priority queue contains objects that are created by clients but assumes that client code does not change the keys (which might invalidate the heap-order invariant). It is possible to develop mechanisms to enforce this assumption, but programmers typically do not do so because they complicate the code and are likely to degrade performance.

Index priority queue. In many applications, it makes sense to allow clients to refer to items that are already on the priority queue. One easy way to do so is to associate a unique integer *index* with each item. Moreover, it is often the case that clients have a universe of items of a known size N and perhaps are using (parallel) arrays to store information about the items, so other unrelated client code might already be using an integer index to refer to items. These considerations lead us to the following API:

```
public class IndexMinPQ<Item extends Comparable<Item>>
```

IndexMinPQ(int maxN)	<i>create a priority queue of capacity maxN with possible indices between 0 and maxN-1</i>
void insert(int k, Item item)	<i>insert item; associate it with k</i>
void change(int k, Item item)	<i>change the item associated with k to item</i>
boolean contains(int k)	<i>is k associated with some item?</i>
void delete(int k)	<i>remove k and its associated item</i>
Item min()	<i>return a minimal item</i>
int minIndex()	<i>return a minimal item's index</i>
int delMin()	<i>remove a minimal item and return its index</i>
boolean isEmpty()	<i>is the priority queue empty?</i>
int size()	<i>number of items in the priority queue</i>

API for a generic priority queue with associated indices

A useful way of thinking of this data type is as implementing an array, but with fast access to the smallest entry in the array. Actually it does even better—it gives fast access to the minimum entry in a *specified subset* of an array’s entries (the ones that have been inserted. In other words, you can think of an `IndexMinPQ` named `pq` as representing a subset of an array `pq[0..N-1]` of items. Think of the call `pq.insert(k, item)` as adding `k` to the subset and setting `pq[k] = item` and the call `pq.change(k, item)` as setting `pq[k] = item`, both also maintaining data structures needed to support the other operations, most importantly `delMin()` (remove and return the index of the minimum key) and `change()` (change the item associated with an index that is already in the data structure—just as in `pq[i] = item`). These operations are important in many applications and are enabled by our ability to refer to the key (with the index). EXERCISE 2.4.33 describes how to extend ALGORITHM 2.6 to implement index priority queues with remarkable efficiency and with remarkably little code. Intuitively, when an item in the heap changes, we can restore the heap invariant with a sink operation (if the key increases) and a swim operation (if the key decreases). To perform the operations, we use the index to find the item in the heap. The ability to locate an item in the heap also allows us to add the `delete()` operation to the API.

Proposition Q (continued). In an index priority queue of size N , the number of compares required is proportional to at most $\log N$ for *insert*, *change priority*, *delete*, and *remove the minimum*.

Proof: Immediate from inspection of the code and the fact that all paths in a heap are of length at most $\sim \lg N$.

operation	order of growth of number of compares
<code>insert()</code>	$\log N$
<code>change()</code>	$\log N$
<code>contains()</code>	1
<code>delete()</code>	$\log N$
<code>min()</code>	1
<code>minIndex()</code>	1
<code>delMin()</code>	$\log N$

Worst-case costs for an N -item heap-based indexed priority queue

This discussion is for a minimum-oriented queue; as usual, we also implement on the booksite a maximum-oriented version `IndexMaxPQ`.

Index priority-queue client. The `IndexMinPQ` client `Multiway` on page 322 solves the *multiway merge* problem: it merges together several sorted input streams into one sorted output stream. This problem arises in many applications: the streams might be the output of scientific instruments (sorted by time), lists of information from the web such as music or movies (sorted by title or artist name), commercial transactions (sorted by account number or time), or whatever. If you have the space, you might just read them all into an array and sort them, but with a priority queue, you can read input streams and put them in sorted order on the output *no matter how long they are*.

Multiway merge priority-queue client

```

public class Multiway
{
    public static void merge(In[] streams)
    {
        int N = streams.length;
        IndexMinPQ<String> pq = new IndexMinPQ<String>(N);

        for (int i = 0; i < N; i++)
            if (!streams[i].isEmpty())
                pq.insert(i, streams[i].readString());

        while (!pq.isEmpty())
        {
            StdOut.println(pq.min());
            int i = pq.delMin();
            if (!streams[i].isEmpty())
                pq.insert(i, streams[i].readString());
        }
    }

    public static void main(String[] args)
    {
        int N = args.length;
        In[] streams = new In[N];
        for (int i = 0; i < N; i++)
            streams[i] = new In(args[i]);
        merge(streams);
    }
}

```

This `IndexMinPQ` client merges together the sorted input stream given as command-line arguments into a single sorted output stream on standard output (see text). Each stream index is associated with a key (the next string in the stream). After initialization, it enters a loop that prints the smallest string in the queue and removes the corresponding entry, then adds a new entry for the next string in that stream. For economy, the output is shown on one line below—the actual output is one string per line.

```

% more m1.txt
A B C F G I I Z
% more m2.txt
B D H P Q Q
% more m3.txt
A B E F J N

```

```

% java Multiway m1.txt m2.txt m3.txt
A A B B B C D E F F G H I I J N P Q Q Z

```

Heapsort We can use any priority queue to develop a sorting method. We insert all the items to be sorted into a minimum-oriented priority queue, then repeatedly use *remove the minimum* to remove them all in order. Using a priority queue represented as an unordered array in this way corresponds to doing a selection sort; using an ordered array corresponds to doing an insertion sort. What sorting method do we get if we use a heap? An entirely different one! Next, we use the heap to develop a classic elegant sorting algorithm known as *heapsort*.

Heapsort breaks into two phases: *heap construction*, where we reorganize the original array into a heap, and the *sortdown*, where we pull the items out of the heap in decreasing order to build the sorted result. For consistency with the code we have studied, we use a maximum-oriented priority queue and repeatedly remove the maximum. Focusing on the task of sorting, we abandon the notion of hiding the representation of the priority queue and use `swim()` and `sink()` directly. Doing so allows us to sort an array without needing any extra space, by maintaining the heap within the array to be sorted.

Heap construction. How difficult is the process of building a heap from N given items? Certainly we can accomplish this task in time proportional to $N \log N$, by proceeding from left to right through the array, using `swim()` to ensure that the items to the left of the scanning pointer make up a heap-ordered complete tree, like successive priority-queue insertions. A clever method that is much more efficient is to proceed from right to left, using `sink()` to make subheaps as we go. Every position in the array is the root of a small subheap; `sink()` works for such subheaps, as well. If the two children of a node are heaps, then calling `sink()` on that node makes the subtree rooted at the parent a heap. This process establishes the heap order inductively. The scan starts halfway back through the array because we can skip the subheaps of size 1. The scan ends at position 1, when we finish building the heap with one call to `sink()`. As the first phase of a sort, heap construction is a bit counterintuitive, because its goal is to produce a heap-ordered result, which has the largest item first in the array (and other larger items near the beginning), not at the end, where it is destined to finish.

Proposition R. Sink-based heap construction uses fewer than $2N$ compares and fewer than N exchanges to construct a heap from N items.

Proof: This fact follows from the observation that most of the heaps processed are small. For example, to build a heap of 127 elements, we process 32 heaps of size 3, 16 heaps of size 7, 8 heaps of size 15, 4 heaps of size 31, 2 heaps of size 63, and 1 heap of size 127, so $32 \cdot 1 + 16 \cdot 2 + 8 \cdot 3 + 4 \cdot 4 + 2 \cdot 5 + 1 \cdot 6 = 120$ exchanges (twice as many compares) are required (at worst). See EXERCISE 2.4.20 for a complete proof.

ALGORITHM 2.7 Heapsort

```

public static void sort(Comparable[] a)
{
    int N = a.length;
    for (int k = N/2; k >= 1; k--)
        sink(a, k, N);
    while (N > 1)
    {
        exch(a, 1, N--);
        sink(a, 1, N);
    }
}

```

This code sorts $a[1]$ through $a[N]$ using the `sink()` method (modified to take $a[]$ and N as arguments). The `for` loop constructs the heap; then the `while` loop exchanges the largest element $a[1]$ with $a[N]$ and then repairs the heap, continuing until the heap is empty. Decrementing the array indices in the implementations of `exch()` and `less()` gives an implementation that sorts $a[0]$ through $a[N-1]$, consistent with our other sorts.

		a[i]											
N	k	0	1	2	3	4	5	6	7	8	9	10	11
<i>initial values</i>		S	O	R	T	E	X	A	M	P	L	E	
11	5	S	O	R	T	L	X	A	M	P	E	E	
11	4	S	O	R	T	L	X	A	M	P	E	E	
11	3	S	O	X	T	L	R	A	M	P	E	E	
11	2	S	T	X	P	L	R	A	M	O	E	E	
11	1	X	T	S	P	L	R	A	M	O	E	E	
<i>heap-ordered</i>		X	T	S	P	L	R	A	M	O	E	E	
10	1	T	P	S	O	L	R	A	M	E	E	X	
9	1	S	P	R	O	L	E	A	M	E	T	X	
8	1	R	P	E	O	L	E	A	M	S	T	X	
7	1	P	O	E	M	L	E	A	R	S	T	X	
6	1	O	M	E	A	L	E	P	R	S	T	X	
5	1	M	L	E	A	E	O	P	R	S	T	X	
4	1	L	E	E	A	M	O	P	R	S	T	X	
3	1	E	A	E	L	M	O	P	R	S	T	X	
2	1	E	A	E	L	M	O	P	R	S	T	X	
1	1	A	E	E	L	M	O	P	R	S	T	X	
<i>sorted result</i>		A	E	E	L	M	O	P	R	S	T	X	

Heapsort trace (array contents just after each sink)

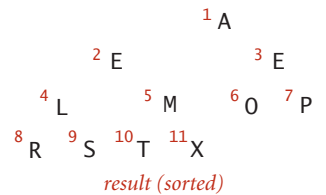
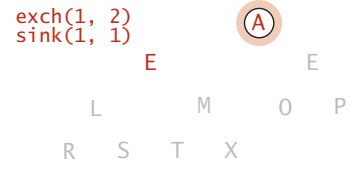
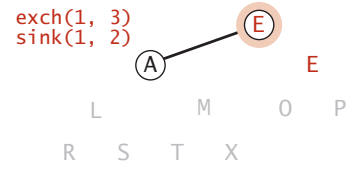
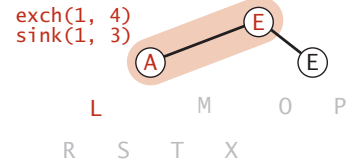
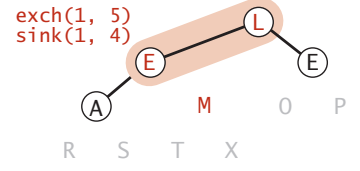
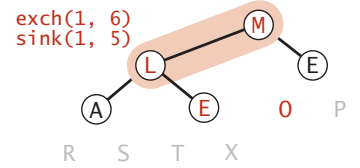
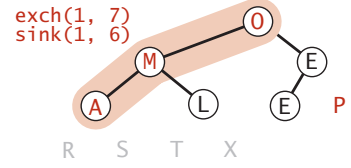
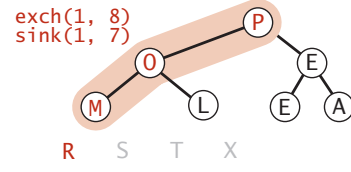
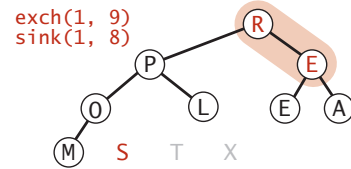
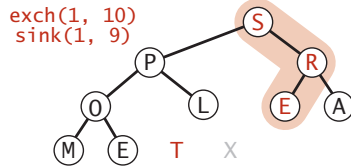
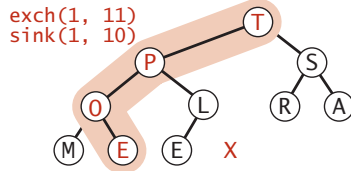
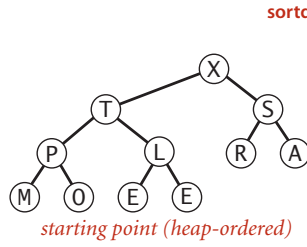
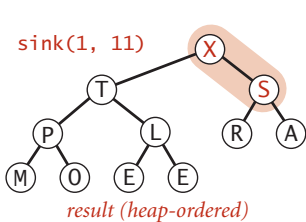
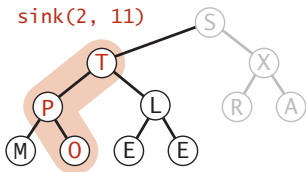
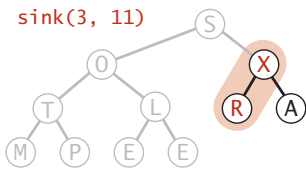
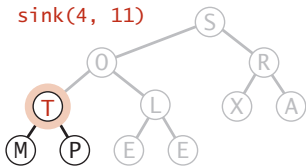
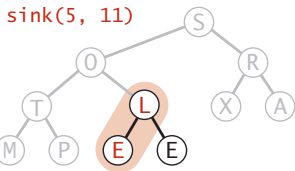
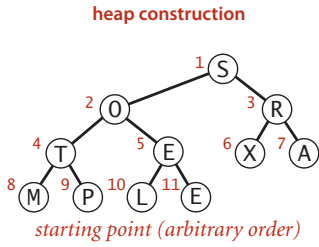

Heapsort: constructing (left) and sorting down (right) a heap

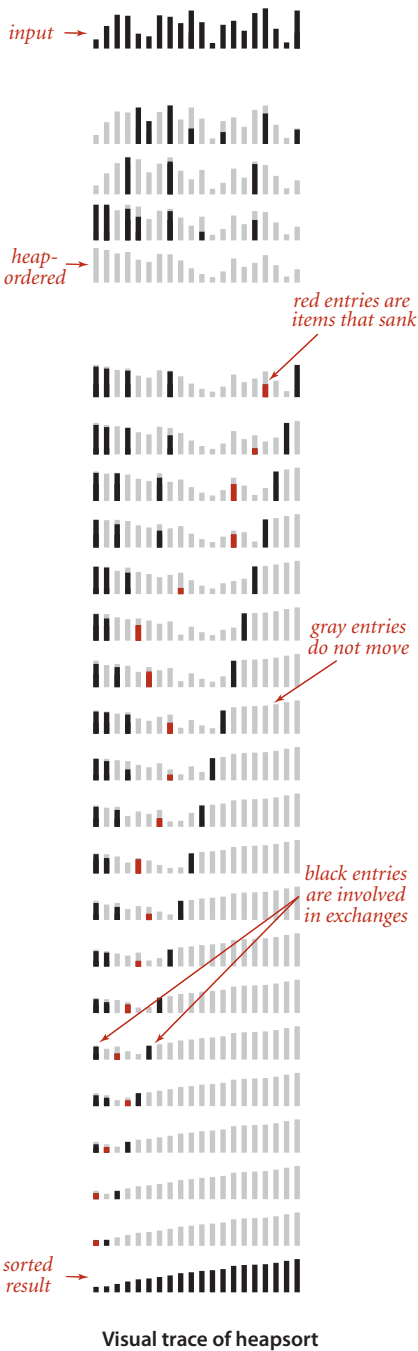

Sortdown. Most of the work during heapsort is done during the second phase, where we remove the largest remaining item from the heap and put it into the array position vacated as the heap shrinks. This process is a bit like selection sort (taking the items in decreasing order instead of in increasing order), but it uses many fewer compares because the heap provides a much more efficient way to find the largest item in the unsorted part of the array.

Proposition S. Heapsort uses fewer than $2N \lg N + 2N$ compares (and half that many exchanges) to sort N items.

Proof: The $2N$ term covers the cost of heap construction (see PROPOSITION R). The $2N \lg N$ term follows from bounding the cost of each sink operation during the sort-down by $2 \lg N$ (see PROPOSITION PQ).

ALGORITHM 2.7 is a full implementation based on these ideas, the classical *heapsort* algorithm, which was invented by J. W. J. Williams and refined by R. W. Floyd in 1964. Although the loops in this program seem to do different tasks (the first constructs the heap, and the second destroys the heap for the sortdown), they are both built around the `sink()` method. We provide an implementation outside of our priority-queue API to highlight the simplicity of the sorting algorithm (eight lines of code for `sort()` and another eight lines of code for `sink()`) and to make it an in-place sort.

As usual, you can gain some insight into the operation of the algorithm by studying a visual trace. At first, the process seems to do anything but sort, because large items are moving to the beginning of the array as the heap is being constructed. But then the method looks more like a mirror image of selection sort (except that it uses far fewer compares).

As for all of the other methods that we have studied, various people have investigated ways to improve heap-based priority-queue implementations and heapsort. We now briefly consider one of them.

Sink to the bottom, then swim. Most items reinserted into the heap during sortdown go all the way to the bottom. Floyd observed in 1964 that we can thus save time by avoiding the check for whether the item has reached its position, simply promoting the larger of the two children until the bottom is reached, then moving back up the heap to the proper position. This idea cuts the number of compares by a factor of 2 asymptotically—close to the number used by mergesort (for a randomly-ordered array). The method requires extra bookkeeping, and it is useful in practice only when the cost of compares is relatively high (for example, when we are sorting items with strings or other types of long keys).

HEAPSORT IS SIGNIFICANT in the study of the complexity of sorting (see page 279) because it is the only method that we have seen that is optimal (within a constant factor) in its use of both time and space—it is guaranteed to use $\sim 2N \lg N$ compares and constant extra space in the worst case. When space is very tight (for example, in an embedded system or on a low-cost mobile device) it is popular because it can be implemented with just a few dozen lines (even in machine code) while still providing optimal performance. However, it is rarely used in typical applications on modern systems because it has poor cache performance: array entries are rarely compared with nearby array entries, so the number of cache misses is far higher than for quicksort, mergesort, and even shellsort, where most compares are with nearby entries.

On the other hand, the use of heaps to implement priority queues plays an increasingly important role in modern applications, because it provides an easy way to guarantee logarithmic running time for dynamic situations where large numbers of *insert* and *remove the maximum* operations are intermixed. We will encounter several examples later in this book.

Q&A

Q. I'm still not clear on the purpose of priority queues. Why exactly don't we just sort and then consider the items in increasing order in the sorted array?

A. In some data-processing examples such as `TopM` and `MultWay`, the total amount of data is far too large to consider sorting (or even storing in memory). If you are looking for the top ten entries among a billion items, do you really want to sort a billion-entry array? With a priority queue, you can do it with a ten-entry priority queue. In other examples, all the data does not even exist together at any point in time: we take something from the priority queue, process it, and as a result of processing it perhaps add some more things to the priority queue.

Q. Why not use `Comparable`, as we do for sorts, instead of the generic `Item` in `MaxPQ`?

A. Doing so would require the client to cast the return value of `delMax()` to an actual type, such as `String`. Generally, casts in client code are to be avoided.

Q. Why not use `a[0]` in the heap representation?

A. Doing so simplifies the arithmetic a bit. It is not difficult to implement the heap methods based on a 0-based heap where the children of `a[0]` are `a[1]` and `a[2]`, the children of `a[1]` are `a[3]` and `a[4]`, the children of `a[2]` are `a[5]` and `a[6]`, and so forth, but most programmers prefer the simpler arithmetic that we use. Also, using `a[0]` as a sentinel value (in the parent of `a[1]`) is useful in some heap applications.

Q. Building a heap in heapsort by inserting items one by one seems simpler to me than the tricky bottom-up method described on page 323 in the text. Why bother?

A. For a sort implementation, it is 20 percent faster and requires half as much tricky code (no `swim()` needed). The difficulty of understanding an algorithm has not necessarily much to do with its simplicity, or its efficiency.

Q. What happens if I leave off the `extends Comparable<Key>` phrase in an implementation like `MaxPQ`?

A. As usual, the easiest way for you to answer a question of this sort for yourself is to simply try it. If you do so for `MaxPQ` you will get a compile-time error:

```
MaxPQ.java:21: cannot find symbol
  symbol   : method compareTo(Item)
```

which is Java's way of telling you that it does not know about `compareTo()` in `Item` because you neglected to declare that `Item` `extends Comparable<Item>`.

EXERCISES

2.4.1 Suppose that the sequence P R I O * R * * I * T * Y * * * Q U E * * * U * E (where a letter means *insert* and an asterisk means *remove the maximum*) is applied to an initially empty priority queue. Give the sequence of letters returned by the *remove the maximum* operations.

2.4.2 Criticize the following idea: To implement *find the maximum* in constant time, why not use a stack or a queue, but keep track of the maximum value inserted so far, then return that value for *find the maximum*?

2.4.3 Provide priority-queue implementations that support *insert* and *remove the maximum*, one for each of the following underlying data structures: unordered array, ordered array, unordered linked list, and linked list. Give a table of the worst-case bounds for each operation for each of your four implementations.

2.4.4 Is an array that is sorted in decreasing order a max-oriented heap?

2.4.5 Give the heap that results when the keys E A S Y Q U E S T I O N are inserted in that order into an initially empty max-oriented heap.

2.4.6 Using the conventions of EXERCISE 2.4.1, give the sequence of heaps produced when the operations P R I O * R * * I * T * Y * * * Q U E * * * U * E are performed on an initially empty max-oriented heap.

2.4.7 The largest item in a heap must appear in position 1, and the second largest must be in position 2 or position 3. Give the list of positions in a heap of size 31 where the k th largest (*i*) can appear, and (*ii*) cannot appear, for $k=2, 3, 4$ (assuming the values to be distinct).

2.4.8 Answer the previous exercise for the k th *smallest* item.

2.4.9 Draw all of the different heaps that can be made from the five keys A B C D E, then draw all of the different heaps that can be made from the five keys A A A B B.

2.4.10 Suppose that we wish to avoid wasting one position in a heap-ordered array $pq[]$, putting the largest value in $pq[0]$, its children in $pq[1]$ and $pq[2]$, and so forth, proceeding in level order. Where are the parents and children of $pq[k]$?

2.4.11 Suppose that your application will have a huge number of *insert* operations, but only a few *remove the maximum* operations. Which priority-queue implementation do you think would be most effective: heap, unordered array, or ordered array?

EXERCISES *(continued)*

2.4.12 Suppose that your application will have a huge number of *find the maximum* operations, but a relatively small number of *insert* and *remove the maximum* operations. Which priority-queue implementation do you think would be most effective: heap, unordered array, or ordered array?

2.4.13 Describe a way to avoid the $j < N$ test in `sink()`.

2.4.14 What is the minimum number of items that must be exchanged during a *remove the maximum* operation in a heap of size N with no duplicate keys? Give a heap of size 15 for which the minimum is achieved. Answer the same questions for two and three successive *remove the maximum* operations.

2.4.15 Design a linear-time certification algorithm to check whether an array `pq[]` is a min-oriented heap.

2.4.16 For $N=32$, give arrays of items that make heapsort use as *many* and as *few* compares as possible.

2.4.17 Prove that building a minimum-oriented priority queue of size k then doing $N - k$ *replace the minimum* (*insert* followed by *remove the minimum*) operations leaves the k largest of the N items in the priority queue.

2.4.18 In `MaxPQ`, suppose that a client calls `insert()` with an item that is larger than all items in the queue, and then immediately calls `delMax()`. Assume that there are no duplicate keys. Is the resulting heap identical to the heap as it was before these operations? Answer the same question for two `insert()` operations (the first with a key larger than all keys in the queue and the second for a key larger than that one) followed by two `delMax()` operations.

2.4.19 Implement the constructor for `MaxPQ` that takes an array of items as argument, using the bottom-up heap construction method described on page 323 in the text.

2.4.20 Prove that sink-based heap construction uses fewer than $2N$ compares and fewer than N exchanges.

CREATIVE PROBLEMS

2.4.21 *Elementary data structures.* Explain how to use a priority queue to implement the stack, queue, and randomized queue data types from CHAPTER 1.

2.4.22 *Array resizing.* Add array resizing to MaxPQ, and prove bounds like those of PROPOSITION Q for array accesses, in an amortized sense.

2.4.23 *Multiway heaps.* Considering the cost of compares only, and assuming that it takes t compares to find the largest of t items, find the value of t that minimizes the coefficient of $N \lg N$ in the compare count when a t -ary heap is used in heapsort. First, assume a straightforward generalization of `sink()`; then, assume that Floyd's method can save one compare in the inner loop.

2.4.24 *Priority queue with explicit links.* Implement a priority queue using a heap-ordered binary tree, but use a triply linked structure instead of an array. You will need three links per node: two to traverse down the tree and one to traverse up the tree. Your implementation should guarantee logarithmic running time per operation, even if no maximum priority-queue size is known ahead of time.

2.4.25 *Computational number theory.* Write a program `CubeSum.java` that prints out all integers of the form $a^3 + b^3$ where a and b are integers between 0 and N in sorted order, without using excessive space. That is, instead of computing an array of the N^2 sums and sorting them, build a minimum-oriented priority queue, initially containing $(0^3, 0, 0), (1^3, 1, 0), (2^3, 2, 0), \dots, (N^3, N, 0)$. Then, while the priority queue is nonempty, *remove the smallest item* $(i^3 + j^3, i, j)$, print it, and then, if $j < N$, *insert the item* $(i^3 + (j+1)^3, i, j+1)$. Use this program to find all distinct mintegers a, b, c , and d between 0 and 10^6 such that $a^3 + b^3 = c^3 + d^3$.

2.4.26 *Heap without exchanges.* Because the `exch()` primitive is used in the `sink()` and `swim()` operations, the items are loaded and stored twice as often as necessary. Give more efficient implementations that avoid this inefficiency, a la insertion sort (see EXERCISE 2.1.25).

2.4.27 *Find the minimum.* Add a `min()` method to MaxPQ. Your implementation should use constant time and constant extra space.

2.4.28 *Selection filter.* Write a `TopM` client that reads points (x, y, z) from standard input, takes a value M from the command line, and prints the M points that are closest to the origin in Euclidean distance. Estimate the running time of your client for $N = 10^8$

CREATIVE PROBLEMS *(continued)*

and $M = 10^4$.

2.4.29 *Min/max priority queue.* Design a data type that supports the following operations: *insert*, *delete the maximum*, and *delete the minimum* (all in logarithmic time); and *find the maximum* and *find the minimum* (both in constant time). *Hint:* Use two heaps.

2.4.30 *Dynamic median-finding.* Design a data type that supports *insert* in logarithmic time, *find the median* in constant time, and *delete the median* in logarithmic time. *Hint:* Use a min-heap and a max-heap.

2.4.31 *Fast insert.* Develop a compare-based implementation of the `MinPQ` API such that *insert* uses $\sim \log \log N$ compares and *delete the minimum* uses $\sim 2 \log N$ compares. *Hint:* Use binary search on parent pointers to find the ancestor in `swim()`.

2.4.32 *Lower bound.* Prove that it is impossible to develop a compare-based implementation of the `MinPQ` API such that both *insert* and *delete the minimum* guarantee to use $\sim N \log \log N$ compares.

2.4.33 *Index priority-queue implementation.* Implement the basic operations in the index priority-queue API on page 320 by modifying ALGORITHM 2.6 as follows: Change `pq[]` to hold indices, add an array `keys[]` to hold the key values, and add an array `qp[]` that is the inverse of `pq[]` — `qp[i]` gives the position of `i` in `pq[]` (the index `j` such that `pq[j]` is `i`). Then modify the code in ALGORITHM 2.6 to maintain these data structures. Use the convention that `qp[i] = -1` if `i` is not on the queue, and include a method `contains()` that tests this condition. You need to modify the helper methods `exch()` and `less()` but not `sink()` or `swim()`.

Partial solution:

```

public class IndexMinPQ<Key extends Comparable<Key>>
{
    private int N;           // number of elements on PQ
    private int[] pq;       // binary heap using 1-based indexing
    private int[] qp;       // inverse: qp[pq[i]] = pq[qp[i]] = i
    private Key[] keys;     // items with priorities
    public IndexMinPQ(int maxN)
    {
        keys = (Key[]) new Comparable[maxN + 1];
        pq  = new int[maxN + 1];
        qp  = new int[maxN + 1];
        for (int i = 0; i <= maxN; i++) qp[i] = -1;
    }

    public boolean isEmpty()
    { return N == 0; }

    public boolean contains(int k)
    { return qp[k] != -1; }

    public void insert(int k, Key key)
    {
        N++;
        qp[k] = N;
        pq[N] = k;
        keys[k] = key;
        swim(N);
    }

    public Item min()
    { return keys[pq[1]]; }

    public int delMin()
    {
        int indexOfMin = pq[1];
        exch(1, N--);
        sink(1);
        keys[pq[N+1]] = null;
        qp[pq[N+1]] = -1;
        return indexOfMin;
    }
}

```

CREATIVE PROBLEMS *(continued)*

2.4.34 *Index priority-queue implementation (additional operations).* Add `minIndex()`, `change()`, and `delete()` to your implementation of EXERCISE 2.4.33.

Solution:

```
public int minIndex()
{ return pq[1]; }

public void change(int k, Item item)
{
    keys[k] = key;
    swim(qp[k]);
    sink(qp[k]);
}

public void delete(int k)
{
    exch(k, N--);
    swim(qp[k]);
    sink(qp[k]);
    keys[pq[N+1]] = null;
    qp[pq[N+1]] = -1;
}
```

2.4.35 *Sampling from a discrete probability distribution.* Write a class `Sample` with a constructor that takes an array `p[]` of `double` values as argument and supports the following two operations: `random()`—return an index `i` with probability $p[i]/T$ (where T is the sum of the numbers in `p[]`)—and `change(i, v)`—change the value of `p[i]` to `v`. *Hint:* Use a complete binary tree where each node has implied weight $p[i]$. Store in each node the cumulative weight of all the nodes in its subtree. To generate a random index, pick a random number between 0 and T and use the cumulative weights to determine which branch of the subtree to explore. When updating `p[i]`, change all of the weights of the nodes on the path from the root to `i`. Avoid explicit pointers, as we do for heaps.

EXPERIMENTS

2.4.36 *Performance driver I.* Write a performance driver client program that uses *insert* to fill a priority queue, then uses *remove the maximum* to remove half the keys, then uses *insert* to fill it up again, then uses *remove the maximum* to remove all the keys, doing so multiple times on random sequences of keys of various lengths ranging from small to large; measures the time taken for each run; and prints out or plots the average running times.

2.4.37 *Performance driver II.* Write a performance driver client program that uses *insert* to fill a priority queue, then does as many *remove the maximum* and *insert* operations as it can do in 1 second, doing so multiple times on random sequences of keys of various lengths ranging from small to large; and prints out or plots the average number of *remove the maximum* operations it was able to do.

2.4.38 *Exercise driver.* Write an exercise driver client program that uses the methods in our priority-queue interface of ALGORITHM 2.6 on difficult or pathological cases that might turn up in practical applications. Simple examples include keys that are already in order, keys in reverse order, all keys the same, and sequences of keys having only two distinct values.

2.4.39 *Cost of construction.* Determine empirically the percentage of time heapsort spends in the construction phase for $N = 10^3$, 10^6 , and 10^9 .

2.4.40 *Floyd's method.* Implement a version of heapsort based on Floyd's sink-to-the-bottom-and-then-swim idea, as described in the text. Count the number of compares used by your program and the number of compares used by the standard implementation, for randomly ordered distinct keys with $N = 10^3$, 10^6 , and 10^9 .

2.4.41 *Multiway heaps.* Implement a version of heapsort based on complete heap-ordered 3-ary and 4-ary trees, as described in the text. Count the number of compares used by each and the number of compares used by the standard implementation, for randomly ordered distinct keys with $N = 10^3$, 10^6 , and 10^9 .

2.4.42 *Preorder heaps.* Implement a version of heapsort based on the idea of representing the heap-ordered tree in preorder rather than in level order. Count the number of compares used by your program and the number of compares used by the standard implementation, for randomly ordered keys with $N = 10^3$, 10^6 , and 10^9 .



2.5 APPLICATIONS

`SORTING ALGORITHMS` and priority queues are widely used in a broad variety of applications. Our purpose in this section is to briefly survey some of these applications, consider ways in which the efficient methods that we have considered play a critical role in such applications, and discuss some of the steps needed to make use of our sort and priority-queue code.

A prime reason why sorting is so useful is that it is much easier to search for an item in a sorted array than in an unsorted one. For over a century, people found it easy to look up someone's phone number in a phone book where items are sorted by last name. Now digital music players organize song files by artist name or song title; search engines display search results in descending order of importance; spreadsheets display columns sorted by a particular field; matrix-processing packages sort the real eigenvalues of a symmetric matrix in descending order; and so forth. Other tasks are also made easier once an array is in sorted order: from looking up an item in the sorted index in the back of this book; to removing duplicates from a long list such as a mailing list, a list of voters, or a list of websites; to performing statistical calculations such as removing outliers, finding the median, or computing percentiles.

Sorting also arises as a critical subproblem in many applications that appear to have nothing to do with sorting at all. Data compression, computer graphics, computational biology, supply-chain management, combinatorial optimization, social choice, and voting are but a few of many examples. The algorithms that we have considered in this chapter play a critical role in the development of effective algorithms in each of the later chapters in this book.

Most important is the system sort, so we begin by considering a number of practical considerations that come into play when building a sort for use by a broad variety of clients. While some of these topics are specific to Java, they each reflect challenges that need to be met in any system.

Our primary purpose is to demonstrate that, even though we have used mechanisms that are relatively simple, the sorting implementations that we are studying are widely applicable. The list of proven applications of fast sorting algorithms is vast, so we can consider just a small fraction of them: some scientific, some algorithmic, and some commercial. You will find many more examples in the exercises, and many more than that on the booksite. Moreover, we will often refer back to this chapter to effectively address the problems that we later consider *in this book!*

Sorting various types of data Our implementations sort arrays of `Comparable` objects. This Java convention allows us to use Java's *callback* mechanism to sort arrays of objects of any type that implements the `Comparable` interface. As described in SECTION 2.1, implementing `Comparable` amounts to defining a `compareTo()` method that implements a *natural ordering* for the type. We can use our code immediately to sort arrays of type `String`, `Integer`, `Double`, and other types such as `File` and `URL`, because these data types all implement `Comparable`. Being able to use the same code for all of those types is convenient, but typical applications involve working with data types that are defined for use within the application. Accordingly it is common to implement a `compareTo()` method for user-defined data types, so that they implement `Comparable`, thus enabling client code to sort arrays of that type (and build priority queues of values of that type).

Transaction example. A prototypical breeding ground for sorting applications is commercial data processing. For example, imagine that a company engaged in internet commerce maintains a record for each transaction involving a customer account that contains all of the pertinent information, such as the customer name, date, amount, and so forth. Nowadays, a successful company needs to be able to handle millions and millions of such transactions. As we saw in EXERCISE 2.1.21, it is reasonable to decide that a natural ordering of such transactions is that they be ordered by amount, which we can implement by adding an appropriate `compareTo()` method in the class definition. With such a definition, we could process an array `a[]` of `Transactions` by, for example, first sorting it with the call `Quick.sort(a)`. Our sorting methods know nothing about our `Transaction` data type, but Java's `Comparable` interface allows us to define a natural ordering so that we can use any of our methods to sort `Transaction` objects. Alternatively, we might specify that `Transaction` objects are to be ordered by date by implementing `compareTo()` to compare the `Date` fields. Since `Date` objects are themselves `Comparable`, we can just invoke the `compareTo()` method in `Date` rather than having to implement it from scratch. It is also reasonable to consider ordering this data by its customer field; arranging to allow clients the flexibility to switch among multiple different orders is an interesting challenge that we will soon consider.

```
public int compareTo(Transaction that)
{ return this.when.compareTo(that.when); }
```

Alternate `compareTo()` implementation for sorting transactions by date

Pointer sorting. The approach we are using is known in the classical literature as *pointer sorting*, so called because we process references to items and do not move the data itself. In programming languages such as C and C++, programmers explicitly decide whether to manipulate data or pointers to data; in Java, pointer manipulation is implicit. Except for primitive numeric types, we *always* manipulate references to objects (pointers), not the objects themselves. Pointer sorting adds a level of indirection: the array contains references to the objects to be sorted, not the objects themselves. We briefly consider some associated issues, in the context of sorting. With multiple reference arrays, we can have multiple different sorted representations of different parts of a single body of data (perhaps using multiple keys, as described below).

Keys are immutable. It stands to reason that an array might not remain sorted if a client is allowed to change the values of keys after the sort. Similarly, a priority queue can hardly be expected to operate properly if the client can change the values of keys between operations. In Java, it is wise to ensure that key values do not change by using immutable keys. Most of the standard data types that you are likely to use as keys, such as `String`, `Integer`, `Double`, and `File`, are immutable.

Exchanges are inexpensive. Another advantage of using references is that we avoid the cost of moving full items. The cost saving is significant for arrays with large items (and small keys) because the compare needs to access just a small part of the item, and most of the item is not even touched during the sort. The reference approach makes the cost of an exchange roughly equal to the cost of a compare for general situations involving arbitrarily large items (at the cost of the extra space for the references). Indeed, if the keys are long, the exchanges might even wind up being less costly than the compare. One way to study the performance of algorithms that sort arrays of numbers is to simply look at the total number of compares and exchanges they use, implicitly making the assumption that the cost of exchanges is the same as the cost of compares. Conclusions based on this assumption are likely to apply to a broad class of applications in Java, because we are sorting reference objects.

Alternate orderings. There are many applications where we want to use different orders for the objects that we are sorting, depending on the situation. The `Java Comparator` interface allows us to build multiple orders within a single class. It has a single public method `compare()` that compares two objects. If we have a data type that implements this interface, we can pass a `Comparator` to `sort()` (which passes it to `less()`) as in the example on the next page. The `Comparator` mechanism allows us to sort arrays of any type of object, using any total order that we wish to define for them. Using a `Comparator` instead of working with `Comparable` types better separates the definition of the type from the definition of what it means to compare two objects of

that type. Indeed, there are typically many possible ways to compare objects, and the `Comparator` mechanism allows us to choose among them. For instance, to sort an array `a[]` of strings without regard to whether characters are uppercase or lowercase you can just call `Insertion.sort(a, String.CASE_INSENSITIVE_ORDER)` which makes use of the `CASE_INSENSITIVE_ORDER` comparator defined in Java's `String` class. As you can imagine, the precise rules for ordering strings are complicated and quite different for various natural languages, so Java has many `String` comparators.

Items with multiple keys. In typical applications, items have multiple instance variables that might need to serve as sort keys. In our transaction example, one client may need to sort the transaction list by customer (for example, to bring together all transactions involving each customer); another client might need to sort the list by amount (for example, to identify high-value transactions); and other clients might need to use other fields as sort keys. The `Comparator` mechanism is precisely what we need to allow this flexibility. We can define multiple comparators, as in the alternate implementation of `Transaction` shown on the bottom of the next page. With this definition, a client can sort an array of `Transaction` objects by time with the call

```
Insertion.sort(a, new Transaction.WhenOrder())
```

or by amount with the call

```
Insertion.sort(a, new Transaction.HowMuchOrder()).
```

The sort does each compare through a *callback* to the `compare()` method in `Transaction` that is specified by the client code. To avoid the cost of making a new `Comparator` object for each sort, we could use `public final` instance variables to define the comparators (as Java does for `CASE_INSENSITIVE_ORDER`).

```
public static void sort(Object[] a, Comparator c)
{
    int N = a.length;
    for (int i = 1; i < N; i++)
        for (int j = i; j > 0 && less(c, a[j], a[j-1]); j--)
            exch(a, j, j-1);
}

private static boolean less(Comparator c, Object v, Object w)
{ return c.compare(v, w) < 0; }

private static void exch(Object[] a, int i, int j)
{ Object t = a[i]; a[i] = a[j]; a[j] = t; }
```

Insertion sorting with a Comparator

Priority queues with comparators. The same flexibility to use comparators is also useful for priority queues. Extending our standard implementation in ALGORITHM 2.6 to support comparators involves the following steps:

- Import `java.util.Comparator`.
- Add to `MaxPQ` an instance variable `comparator` and a constructor that takes a `comparator` as argument and initializes `comparator` to that value.
- Add code to `less()` that checks whether `comparator` is `null` (and uses it if it is not `null`).

For example, with these changes, you could build different priority queues with `Transaction` keys, using the time, place, or account number for the ordering. If you remove the `Key extends Comparable<Key>` phrase from `MinPQ`, you even can support keys with no natural order.

```
import java.util.Comparator;

public class Transaction
{
    ...
    private final String who;
    private final Date when;
    private final double amount;
    ...
    public static class WhoOrder implements Comparator<Transaction>
    {
        public int compare(Transaction v, Transaction w)
        { return v.who.compareTo(w.when); }
    }

    public static class WhenOrder implements Comparator<Transaction>
    {
        public int compare(Transaction v, Transaction w)
        { return v.when.compareTo(w.when); }
    }

    public static class HowMuchOrder implements Comparator<Transaction>
    {
        public int compare(Transaction v, Transaction w)
        {
            if (v.amount < w.amount) return -1;
            if (v.amount > w.amount) return +1;
            return 0;
        }
    }
}
```

Insertion sorting with a `Comparator`

Stability. A sorting method is *stable* if it preserves the relative order of equal keys in the array. This property is frequently important. For example, consider an internet commerce application where we have to process a large number of events that have locations and timestamps. To begin, suppose that we store events in an array as they arrive, so they are in order of the timestamp in the array. Now suppose that the application requires that the transactions be separated out by location for further processing. One easy way to do so is to sort the array by location. If the sort is unstable, the transactions for each city may *not* necessarily be in order by timestamp after the sort. Often, programmers who are unfamiliar with stability are surprised, when they first encounter the situation, by the way an unstable algorithm seems to scramble the data. Some of the sorting methods that we have considered in this chapter are stable (insertion sort and mergesort); many are not (selection sort, shellsort, quicksort, and heapsort). There are ways to trick any sort into stable behavior (see EXERCISE 2.5.18), but using a stable algorithm is generally preferable when stability is an essential requirement. It is easy to take stability for granted; actually, no practical method in common use achieves stability without using significant extra time or space (researchers have developed algorithms that do so, but applications programmers have judged them too complicated to be useful).

sorted by time	sorted by location (not stable)	sorted by location (stable)
Chicago 09:00:00	Chicago 09:25:52	Chicago 09:00:00
Phoenix 09:00:03	Chicago 09:03:13	Chicago 09:00:59
Houston 09:00:13	Chicago 09:21:05	Chicago 09:03:13
Chicago 09:00:59	Chicago 09:19:46	Chicago 09:19:32
Houston 09:01:10	Chicago 09:19:32	Chicago 09:19:46
Chicago 09:03:13	Chicago 09:00:00	Chicago 09:21:05
Seattle 09:10:11	Chicago 09:35:21	Chicago 09:25:52
Seattle 09:10:25	Chicago 09:00:59	Chicago 09:35:21
Phoenix 09:14:25	Houston 09:01:10	Houston 09:00:13
Chicago 09:19:32	Houston 09:00:13	Houston 09:01:10
Chicago 09:19:46	Phoenix 09:37:44	Phoenix 09:00:03
Chicago 09:21:05	Phoenix 09:00:03	Phoenix 09:14:25
Seattle 09:22:43	Phoenix 09:14:25	Phoenix 09:37:44
Seattle 09:22:54	Seattle 09:10:25	Seattle 09:10:11
Chicago 09:25:52	Seattle 09:36:14	Seattle 09:10:25
Chicago 09:35:21	Seattle 09:22:43	Seattle 09:22:43
Seattle 09:36:14	Seattle 09:10:11	Seattle 09:22:54
Phoenix 09:37:44	Seattle 09:22:54	Seattle 09:36:14

Stability when sorting on a second key

Which sorting algorithm should I use? We have considered numerous sorting algorithms in this chapter, so this question is natural. Knowing which algorithm is best possible depends heavily on details of the application and implementation, but we have studied some general-purpose methods that can be nearly as effective as the best possible for a wide variety of applications.

The table at the bottom of this page is a general guide that summarizes the important characteristics of the sort algorithms that we have studied in this chapter. In all cases but shellsort (where the growth rate is only an estimate), insertion sort (where the growth rate depends on the order of the input keys), and both versions of quicksort (where the growth rate is probabilistic and may depend on the distribution of input key values), multiplying these growth rates by appropriate constants gives an effective way to predict running time. The constants involved are partly algorithm-dependent (for example, heapsort uses twice the number of compares as mergesort and both do many more array accesses than quicksort) but are primarily dependent on the implementation, the Java compiler, and your computer, which determine the number of machine instructions that are executed and the time that each requires. Most important, since they are constants, you can generally predict the running time for large N by running experiments for smaller N and extrapolating, using our standard doubling protocol.

algorithm	stable?	in place?	order of growth to sort N items running time	extra space	notes
<i>selection sort</i>	no	yes	N^2	1	
<i>insertion sort</i>	yes	yes	between N and N^2	1	depends on order of items
<i>shellsort</i>	no	yes	$N \log N$? $N^{6/5}$?	1	
<i>quicksort</i>	no	yes	$N \log N$	$\lg N$	probabilistic guarantee
<i>3-way quicksort</i>	no	yes	between N and $N \log N$	$\lg N$	probabilistic, also depends on distribution of input keys
<i>mergesort</i>	yes	no	$N \log N$	N	
<i>heapsort</i>	no	yes	$N \log N$	1	

Performance characteristics of sorting algorithms

Property T. Quicksort is the fastest general-purpose sort.

Evidence: This hypothesis is supported by countless implementations of quicksort on countless computer systems since its invention decades ago. Generally, the reason that quicksort is fastest is that it has only a few instructions in its inner loop (and it does well with cache memories because it most often references data sequentially) so that its running time is $\sim c N \lg N$ with the value of c smaller than the corresponding constants for other linearithmic sorts. With 3-way partitioning, quicksort becomes linear for certain key distributions likely to arise in practice, where other sorts are linearithmic.

Thus, in most practical situations, quicksort is the method of choice. Still, given the broad reach of sorting and the broad variety of computers and systems, a flat statement like this is difficult to justify. For example, we have already seen one notable exception: if stability is important and space is available, mergesort might be best. We will see other exceptions in CHAPTER 5. With tools like `SortCompare` and a considerable amount of time and effort, you can do a more detailed study of comparative performance of these algorithms and the refinements that we have discussed for your computer, as discussed in several exercises at the end of this section. Perhaps the best way to interpret PROPERTY T is as saying that you certainly should seriously consider using quicksort in any sort application where running time is important.

Sorting primitive types. In some performance-critical applications, the focus may be on sorting numbers, so it is reasonable to avoid the costs of using references and sort primitive types instead. For example, consider the difference between sorting an array of `double` values and sorting an array of `Double` values. In the former case, we exchange the numbers themselves and put them in order in the array; in the latter, we exchange references to `Double` objects, which contain the numbers. If we are doing nothing more than sorting a huge array of numbers, we avoid paying the cost of storing an equal number of references plus the extra cost of accessing the numbers through the references, not to mention the cost of invoking `compareTo()` and `less()` methods. We can develop efficient versions of our sort codes for such purposes by replacing `Comparable` with the primitive type name, and redefining `less()` or just replacing calls to `less()` with code like `a[i] < a[j]` (see EXERCISE 2.1.26).

Java system sort. As an example of applying the information given in the table on page 342, consider Java's primary system sort method, `java.util.Arrays.sort()`. With overloading of argument types, this name actually represents a collection of methods:

- A different method for each primitive type
- A method for data types that implement `Comparable`
- A method that uses a `Comparator`

Java's systems programmers have chosen to use quicksort (with 3-way partitioning) to implement the primitive-type methods, and mergesort for reference-type methods. The primary practical implications of these choices are, as just discussed, to trade speed and memory usage (for primitive types) for stability (for reference types).

THE ALGORITHMS AND IDEAS that we have been considering are an essential part of many modern systems, including Java. When developing Java programs to address an application, you are likely to find that Java's `Arrays.sort()` implementations (perhaps supplemented by your own implementation(s) of `compareTo()` and/or `compare()`) will meet your needs, because you will be using 3-way quicksort or mergesort, both proven classic algorithms.

In this book, we generally will use our own `Quick.sort()` (usually) or `Merge.sort()` (when stability is important and space is not) in sort clients. You may feel free to use `Arrays.sort()` unless you have a good reason to use another specific method.

Reductions The idea that we can use sorting algorithms to solve other problems is an example of a basic technique in algorithm design known as *reduction*. We consider reduction in detail in CHAPTER 6 because of its importance in the theory of algorithms—in the meantime, we will consider several practical examples. A *reduction* is a situation where an algorithm developed for one problem is used to solve another. Applications programmers are quite used to the concept of reduction (whether or not it is explicitly articulated)—every time you make use of a method that solves problem *B* in order to solve problem *A*, you are doing a reduction from *A* to *B*. Indeed, one goal in implementing algorithms is to facilitate reductions by making the algorithms useful for as wide a variety as possible of applications. We begin with a few elementary examples for sorting. Many of these take the form of algorithmic puzzles where a quadratic brute-force algorithm is immediate. It is often the case that sorting the data first makes it easy to finish solving the problem in linear additional time, thus reducing the total cost from quadratic to linearithmic.

Duplicates. Are there any duplicate keys in an array of `Comparable` objects? How many distinct keys are there? Which value appears most frequently? For small arrays, these kinds of questions are easy to answer with a quadratic algorithm that compares each array entry with each other array entry. For large arrays, using a quadratic algorithm is not feasible. With sorting, you can answer these questions in linearithmic time:

first sort the array, then make a pass through the sorted array, taking note of duplicate keys that appear consecutively in the ordered array. For example, the code fragment at right counts the distinct keys in an array. With simple modifications to this code, you can answer the questions above and perform tasks such as printing all the distinct values, all the values that are duplicated, and so forth, even for huge arrays.

Rankings. A *permutation* (or *ranking*) is an array of N integers where each of the integers between 0 and $N-1$ appears exactly once. The *Kendall tau distance* between two rankings is the number of pairs that are in different order in the two rankings. For example, the Kendall tau distance between $0\ 3\ 1\ 6\ 2\ 5\ 4$ and $1\ 0\ 3\ 6\ 4\ 2\ 5$ is four because the pairs $0-1$, $3-1$, $2-4$, $5-4$ are in different relative order in the two rankings, but all other pairs are in the same relative order. This statistic is widely used: in sociology to study social choice and voting theory, in molecular biology to compare genes using expression profiles, and in ranking search engine results on the web, among many other applications. The Kendall tau distance between a permutation and the identity permutation (where each entry is equal to its index) is the number of inversions in the permutation, and a quadratic algorithm based on insertion sort is not difficult to devise (recall PROPOSITION C in SECTION 2.1). Efficiently computing the Kendall tau distance is an interesting exercise for a programmer (or a student!) who is familiar with the classical sorting algorithms that we have studied (see EXERCISE 2.5.19).

```
Quick.sort(a);
int count = 1; // Assume a.length > 0.
for (int i = 1; i < a.length; i++)
    if (a[i].compareTo(a[i-1]) != 0)
        count++;
```

Counting the distinct keys in a[]

Priority-queue reductions. In SECTION 2.4, we considered two examples of problems that reduce to a sequence of operations on priority queues. `TopM`, on page 311, finds the M items in an input stream with the highest keys. `MultWay`, on page 322, merges M sorted input streams together to make a sorted output stream. Both of these problems are easily addressed with a priority queue of size M .

Median and order statistics. An important application related to sorting but for which a full sort is not required is the operation of finding the *median* of a collection of keys (the value with the property that half the keys are no larger and half the keys are no smaller). This operation is a common computation in statistics and in various other data-processing applications. Finding the median is a special case of *selection*: finding the k th smallest of a collection of numbers. Selection has many applications in the processing of experimental and other data. The use of the median and other *order*

statistics to divide an array into smaller groups is common. Often, only a small part of a large array is to be saved for further processing; in such cases, a program that can select, say, the top 10 percent of the items of the array might be more appropriate than a full sort. Our TopM application of SECTION 2.4 solves this problem for an unbounded input stream, using a priority queue. An effective alternative to TopM when you have the items in an array is to just sort it: after the call `Quick.sort(a)` the k smallest values in the array are in the first k array positions for all k less than the array length. But this approach involves a sort, so the running time is linearithmic. Can we do better? Finding the k smallest values in an array is easy when k is very

small or very large, but more challenging

when k is a constant fraction of the array size, such as finding the median ($k = N/2$). You might be surprised to learn that it is possible to solve this problem in *linear* time, as in the `select()` method above (this implementation requires a client cast; for the more pedantic code needed to avoid this requirement, see the booksite). To do the job, `select()` maintains the variables `lo` and `hi` to delimit the subarray that contains the index k of the item to be selected and uses quicksort partitioning to shrink the size of the subarray. Recall that `partition()` rearranges an array `a[lo]` through `a[hi]` and returns an integer j such that `a[lo]` through `a[j-1]` are less than or equal to `a[j]`, and `a[j+1]` through `a[hi]` are greater than or equal to `a[j]`. Now, if k is equal to j , then we are done. Otherwise, if $k < j$, then we need to continue working in the left subarray (by changing the value of `hi` to $j-1$); if $k > j$, then we need to continue working in the right subarray (by changing `lo` to $j+1$). The loop maintains the invariant that no entry to the left of `lo` is larger and no entry to the right of `hi` is smaller than any element within `a[lo..hi]`. After partitioning, we preserve this invariant and shrink the interval until it consists just of

```
public static Comparable
select(Comparable[] a, int k)
{
    StdRandom.shuffle(a);
    int lo = 0, hi = a.length - 1;
    while (hi > lo)
    {
        int j = partition(a, lo, hi);
        if (j == k) return a[k];
        else if (j > k) hi = j - 1;
        else if (j < k) lo = j + 1;
    }
    return a[k];
}
```

Selecting the k smallest elements in `a[]`

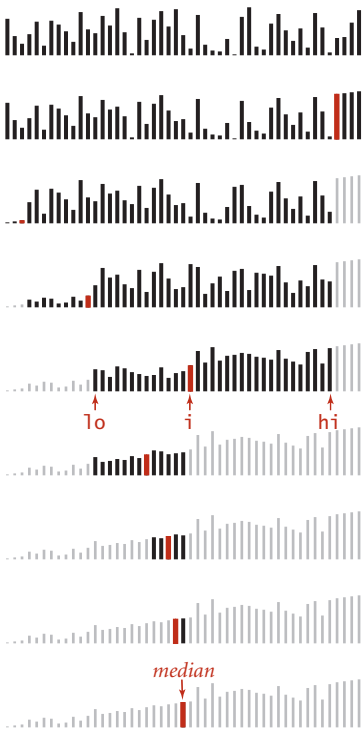

Partitioning to find the median

k. Upon termination, $a[k]$ contains the $(k+1)$ st smallest entry, $a[0]$ through $a[k-1]$ are all smaller than (or equal to) $a[k]$, and $a[k+1]$ through the end of the array are all greater than (or equal to) $a[k]$. To gain some insight into why this is a linear-time algorithm, suppose that partitioning divides the array exactly in half each time. Then the number of compares is $N + N/2 + N/4 + N/8 + \dots$, terminating when the k th smallest item is found. This sum is less than $2N$. As with quicksort, it takes a bit of math to find the true bound, which is a bit higher. Also as with quicksort, the analysis depends on partitioning on a random item, so that the guarantee is probabilistic.

Proposition U. Partitioning-based selection is a linear-time algorithm, on average.

Proof: An analysis similar to, but significantly more complex than, the proof of PROPOSITION K for quicksort leads to the result that the average number of compares is $\sim 2N + 2k \ln(N/k) + 2(N-k) \ln(N/(N-k))$, which is linear for any allowed value of k . For example, this formula says that finding the median ($k = N/2$) requires $\sim (2 + 2 \ln 2)N$ compares, on the average. Note that the worst case is quadratic but randomization protects against that possibility, as with quicksort.

Designing a selection algorithm that is guaranteed to use a linear number of compares in the *worst case* is a classic result in computational complexity, but it has not yet led to a useful practical algorithm.

A brief survey of sorting applications Direct applications of sorting are familiar, ubiquitous, and far too numerous for us to list them all. You sort your music by song title or by artist name, your email or phone calls by time or origin, and your photos by date. Universities sort student accounts by name or ID. Credit card companies sort millions or even billions of transactions by date or amount. Scientists sort not only experimental data by time or other identifier but also to enable detailed simulations of the natural world, from the motion of particles or heavenly bodies to the structure of materials to social interactions and relationships. Indeed, it is difficult to identify a computational application that does *not* involve sorting! To elaborate upon this point, we describe in this section examples of applications that are more complicated than the reductions just considered, including several that we will examine in detail later in this book.

Commercial computing. The world is awash in information. Government organizations, financial institutions, and commercial enterprises organize much of this information by sorting it. Whether the information is accounts to be sorted by name or number, transactions to be sorted by date or amount, mail to be sorted by postal code or address, files to be sorted by name or date, or whatever, processing such data is sure to involve a sorting algorithm somewhere along the way. Typically, such information is organized in huge databases, sorted by multiple keys for efficient search. An effective strategy that is widely used is to collect new information, add it to the database, sort it on the keys of interest, and merge the sorted result for each key into the existing database. The methods that we have discussed have been used effectively since the early days of computing to build a huge infrastructure of sorted data and methods for processing it that serve as the basis for all of this commercial activity. Arrays having millions or even billions of entries are routinely processed today—without linearithmic sorting algorithms, such arrays could not be sorted, making such processing extremely difficult or impossible.

Search for information. Keeping data in sorted order makes it possible to efficiently search through it using the classic *binary search* algorithm (see CHAPTER 1). You will also see that the same scheme makes it easy to quickly handle many other kinds of queries. How many items are smaller than a given item? Which items fall within a given range? In CHAPTER 3, we consider such questions. We also consider in detail various extensions to sorting and binary search that allow us to intermix such queries with operations that insert and remove objects from the set, still guaranteeing logarithmic performance for all operations.

Operations research. The field of *operations research* (OR) develops and applies mathematical models for problem-solving and decision-making. We will see several examples in this book of relationships between OR and the study of algorithms, beginning here with the use of sorting in a classic OR problem known as *scheduling*. Suppose that we have N jobs to complete, where job j requires t_j seconds of processing time. We need to complete all of the jobs but want to maximize customer satisfaction by minimizing the average completion time of the jobs. The *shortest processing time first* rule, where we schedule the jobs in increasing order of processing time, is known to accomplish this goal. Therefore we can sort the jobs by processing time or put them on a minimum-oriented priority queue. With various other constraints and restrictions, we get various other scheduling problems, which frequently arise in industrial applications and are well-studied. As another example, consider the *load-balancing problem*, where we have M identical processors and N jobs to complete, and our goal is to schedule all of the jobs on the processors so that the time at which the last job completes is as early as possible. This specific problem is *NP-hard* (see CHAPTER 6) so we do not expect to find a practical way to compute an optimal schedule. One method that is known to produce a good schedule is the *longest processing time first* rule, where we consider the jobs in descending order of processing time, assigning each job to the processor that becomes available first. To implement this algorithm, we first sort the jobs in reverse order. Then we maintain a priority queue of M processors, where the priority is the sum of the processing times of its jobs. At each step, we delete the processor with the minimum priority, add the next job to the processor, and reinsert that processor into the priority queue.

Event-driven simulation. Many scientific applications involve simulation, where the point of the computation is to model some aspect of the real world in order to be able to better understand it. Before the advent of computing, scientists had little choice but to build mathematical models for this purpose; such models are now well-complemented by computational models. Doing such simulations efficiently can be challenging, and use of appropriate algorithms certainly can make the difference between being able to complete the simulation in a reasonable amount of time and being stuck with the choice of accepting inaccurate results or waiting for the simulation to do the computation necessary to get accurate results. We will consider in CHAPTER 6 a detailed example that illustrates this point.

Numerical computations. Scientific computing is often concerned with *accuracy* (how close are we to the true answer?). Accuracy is extremely important when we are performing millions of computations with estimated values such as the floating-point representation of real numbers that we commonly use on computers. Some numerical algorithms use priority queues and sorting to control accuracy in calculations. For

example, one way to do numerical integration (quadrature), where the goal is to estimate the area under a curve, is to maintain a priority queue with accuracy estimates for a set of subintervals that comprise the whole interval. The process is to remove the least accurate subinterval, split it in half (thus achieving better accuracy for the two halves), and put the two halves back onto the priority queue, continuing until a desired tolerance is reached.

Combinatorial search. A classic paradigm in artificial intelligence and in coping with intractable problems is to define a set of *configurations* with well-defined *moves* from one configuration to the next and a priority associated with each move. Also defined is a *start* configuration and a *goal* configuration (which corresponds to having solved the problem). The well-known *A** algorithm is a problem-solving process where we put the start configuration on the priority queue, then do the following until reaching the goal: remove the highest-priority configuration and add to the queue all configurations that can be reached from that with one move (excluding the one just removed). As with event-driven simulation, this process is tailor-made for priority queues. It reduces solving the problem to defining an effective priority function. See EXERCISE 2.5.32 for an example.

BEYOND SUCH DIRECT APPLICATIONS (and we have only indicated a small fraction of those), sorting and priority queues are an essential abstraction in algorithm design, so they will surface frequently throughout this book. We next list some examples of applications from later in the book. All of these applications depend upon the efficient implementations of sorting algorithms and the priority-queue data type that we have considered in this chapter.

Prim's algorithm and Dijkstra's algorithm are classical algorithms from CHAPTER 4. That chapter is about algorithms that process *graphs*, a fundamental model for *items* and *edges* that connect pairs of items. The basis for these and several other algorithms is *graph search*, where we proceed from item to item along edges. Priority queues play a fundamental role in organizing graph searches, enabling efficient algorithms.

Kruskal's algorithm is another classic algorithm for graphs whose edges have weights that depends upon processing the edges in order of their weight. Its running time is dominated by the cost of the sort.

Huffman compression is a classic *data compression* algorithm that depends upon processing a set of items with integer weights by combining the two smallest to produce a new one whose weight is the sum of its two constituents. Implementing this opera-

tion is immediate, using a priority queue. Several other data-compression schemes are based upon sorting.

String-processing algorithms, which are of critical importance in modern applications in cryptology and in genomics, are often based on sorting (generally using one of the specialized string sorts discussed in CHAPTER 5). For example, we will discuss in CHAPTER 6 algorithms for finding the *longest repeated substring* in a given string that is based on first sorting suffixes of the strings.

Q & A

Q. Is there a priority-queue data type in the Java library?

A. Yes, see `java.util.PriorityQueue`.

EXERCISES

2.5.1 Consider the following implementation of the `compareTo()` method for `String`. How does the third line help with efficiency?

```
public int compareTo(String that)
{
    if (this == that) return 0; // this line
    int n = Math.min(this.length(), that.length());
    for (int i = 0; i < n; i++)
    {
        if (this.charAt(i) < that.charAt(i)) return -1;
        else if (this.charAt(i) > that.charAt(i)) return +1;
    }
    return this.length() - that.length();
}
```

2.5.2 Write a program that reads a list of words from standard input and prints all two-word compound words in the list. For example, if `after`, `thought`, and `afterthought` are in the list, then `afterthought` is a compound word.

2.5.3 Criticize the following implementation of a class intended to represent account balances. Why is `compareTo()` a flawed implementation of the `Comparable` interface?

```
public class Balance implements Comparable<Balance>
{
    ...
    private double amount;
    public int compareTo(Balance that)
    {
        if (this.amount < that.amount - 0.005) return -1;
        if (this.amount > that.amount + 0.005) return +1;
        return 0;
    }
    ...
}
```

Describe a way to fix this problem.

2.5.4 Implement a method `String[] dedup(String[] a)` that returns the objects in `a[]` in sorted order, with duplicates removed.

2.5.5 Explain why selection sort is not stable.

EXERCISES *(continued)*

2.5.6 Implement a recursive version of `select()`.

2.5.7 About how many compares are required, on the average, to find the smallest of N items using `select()`?

2.5.8 Write a program `Frequency` that reads strings from standard input and prints the number of times each string occurs, in descending order of frequency.

2.5.9 Develop a data type that allows you to write a client that can sort a file such as the one shown at right.

2.5.10 Create a data type `Version` that represents a software version number, such as `115.1.1`, `115.10.1`, `115.10.2`. Implement the `Comparable` interface so that `115.1.1` is less than `115.10.1`, and so forth.

2.5.11 One way to describe the result of a sorting algorithm is to specify a permutation `p[]` of the numbers `0` to `a.length-1`, such that `p[i]` specifies where the key originally in `a[i]` ends up. Give the permutations that describe the results of insertion sort, selection sort, shellsort, mergesort, quicksort, and heapsort for an array of seven equal keys.

input (DJI volumes for each day)

```
1-Oct-28      3500000
2-Oct-28      3850000
3-Oct-28      4060000
4-Oct-28      4330000
5-Oct-28      4360000
...
30-Dec-99     554680000
31-Dec-99     374049984
3-Jan-00      931800000
4-Jan-00     1009000000
5-Jan-00     1085500032
...
```

output

```
19-Aug-40    130000
26-Aug-40    160000
24-Jul-40    200000
10-Aug-42    210000
23-Jun-42    210000
...
23-Jul-02    2441019904
17-Jul-02    2566500096
15-Jul-02    2574799872
19-Jul-02    2654099968
24-Jul-02    2775559936
```

CREATIVE PROBLEMS

2.5.12 *Scheduling.* Write a program `SPT.java` that reads job names and processing times from standard input and prints a schedule that minimizes average completion time using the shortest processing time first rule, as described on page 349.

2.5.13 *Load balancing.* Write a program `LPT.java` that takes an integer `M` as a command-line argument, reads job names and processing times from standard input and prints a schedule assigning the jobs to `M` processors that approximately minimizes the time when the last job completes using the longest processing time first rule, as described on page 349.

2.5.14 *Sort by reverse domain.* Write a data type `Domain` that represents domain names, including an appropriate `compareTo()` method where the natural order is in order of the *reverse* domain name. For example, the reverse domain of `cs.princeton.edu` is `edu.princeton.cs`. This is useful for web log analysis. *Hint:* Use `s.split("\\.")` to split the string `s` into tokens, delimited by dots. Write a client that reads domain names from standard input and prints the reverse domains in sorted order.

2.5.15 *Spam campaign.* To initiate an illegal spam campaign, you have a list of email addresses from various domains (the part of the email address that follows the `@` symbol). To better forge the return addresses, you want to send the email from another user at the same domain. For example, you might want to forge an email from `wayne@princeton.edu` to `rs@princeton.edu`. How would you process the email list to make this an efficient task?

2.5.16 *Unbiased election.* In order to thwart bias against candidates whose names appear toward the end of the alphabet, California sorted the candidates appearing on its 2003 gubernatorial ballot by using the following order of characters:

R W Q O J M V A H B S G Z X N T C I E K U P D Y F L

Create a data type where this is the natural order and write a client `California` with a single static method `main()` that sorts strings according to this ordering. Assume that each string is composed solely of uppercase letters.

2.5.17 *Check stability.* Extend your `check()` method from EXERCISE 2.1.16 to call `sort()` for a given array and return `true` if `sort()` sorts the array in order *in a stable manner*, `false` otherwise. Do not assume that `sort()` is restricted to move data only with `exch()`.

CREATIVE PROBLEMS *(continued)*

2.5.18 *Force stability.* Write a wrapper method that makes any sort stable by creating a new key type that allows you to append each key's index to the key, call `sort()`, then restore the original key after the sort.

2.5.19 *Kendall tau distance.* Write a program `KendallTau.java` that computes the Kendall tau distance between two permutations in linearithmic time.

2.5.20 *Idle time.* Suppose that a parallel machine processes N jobs. Write a program that, given the list of job start and finish times, finds the largest interval where the machine is idle and the largest interval where the machine is *not* idle.

2.5.21 *Multidimensional sort.* Write a `Vector` data type for use in having the sorting methods sort multidimensional vectors of d integers, putting the vectors in order by first component, those with equal first component in order by second component, those with equal first and second components in order by third component, and so forth.

2.5.22 *Stock market trading.* Investors place buy and sell orders for a particular stock on an electronic exchange, specifying a maximum buy or minimum sell price that they are willing to pay, and how many shares they wish to trade at that price. Develop a program that uses priority queues to match up buyers and sellers and test it through simulation. Maintain two priority queues, one for buyers and one for sellers, executing trades whenever a new order can be matched with an existing order or orders.

2.5.23 *Sampling for selection.* Investigate the idea of using sampling to improve selection. *Hint:* Using the median may not always be helpful.

2.5.24 *Stable priority queue.* Develop a *stable* priority-queue implementation (which returns duplicate keys in the same order in which they were inserted).

2.5.25 *Points in the plane.* Write three `static` comparators for the `Point2D` data type of page 77, one that compares points by their x coordinate, one that compares them by their y coordinate, and one that compares them by their distance from the origin. Write two `non-static` comparators for the `Point2D` data type, one that compares them by their distance to a specified point and one that compares them by their polar angle with respect to a specified point.

2.5.26 *Simple polygon.* Given N points in the plane, draw a simple polygon with N

points as vertices. *Hint*: Find the point p with the smallest y coordinate, breaking ties with the smallest x coordinate. Connect the points in increasing order of the polar angle they make with p .

2.5.27 *Sorting parallel arrays.* When sorting parallel arrays, it is useful to have a version of a sorting routine that returns a permutation, say `index[]`, of the indices in sorted order. Add a method `indirectSort()` to `Insertion` that takes an array of `Comparable` objects `a[]` as argument, but instead of rearranging the entries of `a[]` returns an integer array `index[]` so that `a[index[0]]` through `a[index[N-1]]` are the items in ascending order.

2.5.28 *Sort files by name.* Write a program `FileSorter` that takes the name of a directory as a command-line argument and prints out all of the files in the current directory, sorted by file name. *Hint*: Use the `File` data type.

2.5.29 *Sort files by size and date of last modification.* Write comparators for the type `File` to order by increasing/decreasing order of file size, ascending/descending order of file name, and ascending/descending order of last modification date. Use these comparators in a program `LS` that takes a command-line argument and lists the files in the current directory according to a specified order, e.g., "-t" to sort by timestamp. Support multiple flags to break ties. Be sure to use a stable sort.

2.5.30 *Boerner's theorem.* True or false: If you sort each column of a matrix, then sort each row, the columns are still sorted. Justify your answer.

EXPERIMENTS

2.5.31 Duplicates. Write a client that takes integers M , N , and T as command-line arguments, then uses the code given in the text to perform T trials of the following experiment: Generate N random `int` values between 0 and $M - 1$ and count the number of duplicates. Run your program for $T = 10$ and $N = 10^3, 10^4, 10^5$, and 10^6 , with $M = N/2$, and N , and $2N$. Probability theory says that the number of duplicates should be about $(1 - e^{-\alpha})$ where $\alpha = N/M$ —print a table to help you confirm that your experiments validate that formula.

2.5.32 8 puzzle. The 8 puzzle is a game popularized by S. Loyd in the 1870s. It is played on a 3-by-3 grid with 8 tiles labeled 1 through 8 and a blank square. Your goal is to rearrange the tiles so that they are in order. You are permitted to slide one of the available tiles horizontally or vertically (but not diagonally) into the blank square. Write a program that solves the puzzle using the A^* algorithm. Start by using as priority the sum of the number of moves made to get to this board position plus the number of tiles in the wrong position. (Note that the number of moves you must make from a given board position is at least as big as the number of tiles in the wrong place.) Investigate substituting other functions for the number of tiles in the wrong position, such as the sum of the Manhattan distance from each tile to its correct position, or the sums of the squares of these distances.

2.5.33 Random transactions. Develop a generator that takes an argument N , generates N random `Transaction` objects (see EXERCISES 2.1.21 and 2.1.22), using assumptions about the transactions that you can defend. Then compare the performance of shellsort, mergesort, quicksort, and heapsort for sorting N transactions, for $N = 10^3, 10^4, 10^5$, and 10^6 .

This page intentionally left blank

THREE



Searching

3.1	Symbol Tables	362
3.2	Binary Search Trees	396
3.3	Balanced Search Trees	424
3.4	Hash Tables	458
3.5	Applications.	486

Modern computing and the internet have made accessible a vast amount of information. The ability to efficiently search through this information is fundamental to processing it. This chapter describes classical *searching* algorithms that have proven to be effective in numerous diverse applications for decades. Without algorithms like these, the development of the computational infrastructure that we enjoy in the modern world would not have been possible.

We use the term *symbol table* to describe an abstract mechanism where we save information (a *value*) that we can later search for and retrieve by specifying a *key*. The nature of the keys and the values depends upon the application. There can be a huge number of keys and a huge amount of information, so implementing an efficient symbol table is a significant computational challenge.

Symbol tables are sometimes called *dictionaries*, by analogy with the time-honored system of providing definitions for words by listing them alphabetically in a reference book. In an English-language dictionary, a key is a word and its values is the entry associated with the word that contains the definition, pronunciation, and etymology. Symbol tables are also sometimes called *indices*, by analogy with another time-honored system of providing access to terms by listing them alphabetically at the end of a book such as a textbook. In a book index, a key is a term of interest and its value is the list of page numbers that tell readers where to find that term in the book.

After describing the basic APIs and two fundamental implementations, we consider three classic data structures that can support efficient symbol-table implementations: binary search trees, red-black trees, and hash tables. We conclude with several extensions and applications, many of which would not be feasible without the efficient algorithms that you will learn about in this chapter.

3.1 SYMBOL TABLES

The primary purpose of a symbol table is to associate a *value* with a *key*. The client can *insert* key-value pairs into the symbol table with the expectation of later being able to *search* for the value associated with a given key, from among all of the key-value pairs that have been put into the table. This chapter describes several ways to structure this data so as to make efficient not just the *insert* and *search* operations, but several other convenient operations as well. To implement a symbol table, we need to define an underlying data structure and then specify algorithms for insert, search, and other operations that create and manipulate the data structure.

Search is so important to so many computer applications that symbol tables are available as high-level abstractions in many programming environments, including Java—we shall discuss Java’s symbol-table implementations in SECTION 3.5. The table below gives some examples of keys and values that you might use in typical applications. We consider some illustrative reference clients soon, and SECTION 3.5 is devoted to showing you how to use symbol tables effectively in your own clients. We also use symbol tables in developing other algorithms throughout the book.

Definition. A *symbol table* is a data structure for key-value pairs that supports two operations: *insert* (put) a new pair into the table and *search* for (get) the value associated with a given key.

application	purpose of search	key	value
<i>dictionary</i>	find definition	word	definition
<i>book index</i>	find relevant pages	term	list of page numbers
<i>file share</i>	find song to download	name of song	computer ID
<i>account management</i>	process transactions	account number	transaction details
<i>web search</i>	find relevant web pages	keyword	list of page names
<i>compiler</i>	find type and value	variable name	type and value

Typical symbol-table applications

API The symbol table is a prototypical *abstract data type* (see CHAPTER 1): it represents a well-defined set of values and operations on those values, enabling us to develop clients and implementations separately. As usual, we precisely define the operations by specifying an applications programming interface (API) that provides the contract between client and implementation:

<code>public class ST<Key, Value></code>	
<code>ST()</code>	<i>create a symbol table</i>
<code>void put(Key key, Value val)</code>	<i>put key-value pair into the table (remove key from table if value is null)</i>
<code>Value get(Key key)</code>	<i>value paired with key (null if key is absent)</i>
<code>void delete(Key key)</code>	<i>remove key (and its value) from table</i>
<code>boolean contains(Key key)</code>	<i>is there a value paired with key?</i>
<code>boolean isEmpty()</code>	<i>is the table empty?</i>
<code>int size()</code>	<i>number of key-value pairs in the table</i>
<code>Iterable<Key> keys()</code>	<i>all the keys in the table</i>

API for a generic basic symbol table

Before examining client code, we consider several design choices for our implementations to make our code consistent, compact, and useful.

Generics. As we did with sorting, we will consider the methods without specifying the types of the items being processed, using generics. For symbol tables, we emphasize the separate roles played by keys and values in search by specifying the key and value types explicitly instead of viewing keys as implicit in items as we did for priority queues in SECTION 2.4. After we have considered some of the characteristics of this basic API (for example, note that there is no mention of order among the keys), we will consider an extension for the typical case when keys are `Comparable`, which enables numerous additional methods.

Duplicate keys. We adopt the following conventions in all of our implementations:

- Only one value is associated with each key (no duplicate keys in a table).
- When a client puts a key-value pair into a table already containing that key (and an associated value), the new value replaces the old one.

These conventions define the *associative array abstraction*, where you can think of a symbol table as being just like an array, where keys are indices and values are array

entries. In a conventional array, keys are integer indices that we use to quickly access array values; in an associative array (symbol table), keys are of arbitrary type, but we can still use them to quickly access values. Some programming languages (not Java) provide special support that allows programmers to use code such as `st[key]` for `st.get(key)` and `st[key] = val` for `st.put(key, val)` where `key` and `val` are objects of arbitrary type.

Null keys. Keys must not be `null`. As with many mechanisms in Java, use of a null key results in an exception at runtime (see the third Q&A on page 387).

Null values. We also adopt the convention that no key can be associated with the value `null`. This convention is directly tied to our specification in the API that `get()` should return `null` for keys not in the table, effectively associating the value `null` with every key not in the table. This convention has two (intended) consequences: First, we can test whether or not the symbol table defines a value associated with a given key by testing whether `get()` returns `null`. Second, we can use the operation of calling `put()` with `null` as its second (value) argument to implement deletion, as described in the next paragraph.

Deletion. Deletion in symbol tables generally involves one of two strategies: *lazy* deletion, where we associate keys in the table with `null`, then perhaps remove all such keys at some later time; and *eager* deletion, where we remove the key from the table immediately. As just discussed, the code `put(key, null)` is an easy (lazy) implementation of `delete(key)`. When we give an (eager) implementation of `delete()`, it is intended to replace this default. In our symbol-table implementations that do not use the default `delete()`, the `put()` implementations on the booksite begin with the defensive code

```
if (val == null) { delete(key); return; }
```

to ensure that no key in the table is associated with `null`. For economy, we do not include this code in the book (and we do not call `put()` with a `null` value in client code).

Shorthand methods. For clarity in client code, we include the methods `contains()` and `isEmpty()` in the API, with the default one-line implementations shown here. For economy, we do not repeat this code, but we assume it to be present in all implementations of the symbol-table API and use these methods freely in client code.

method	default implementation
<code>void delete(Key key)</code>	<code>put(key, null);</code>
<code>boolean contains(key)</code>	<code>return get(key) != null;</code>
<code>boolean isEmpty()</code>	<code>return size() == 0;</code>

Default implementations

Iteration. To enable clients to process all the keys and values in the table, we might add the phrase `implements Iterable<Key>` to the first line of the API to specify that every implementation must implement an `iterator()` method that returns an iterator having appropriate implementations of `hasNext()` and `next()`, as described for stacks and queues in SECTION 1.3. For symbol tables, we adopt a simpler alternative approach, where we specify a `keys()` method that returns an `Iterable<Key>` object for clients to use to iterate through the keys. Our reason for doing so is to maintain consistency with methods that we will define for ordered symbol tables that allow clients to iterate through a specified subset of keys in the table.

Key equality. Determining whether or not a given key is in a symbol table is based on the concept of *object equality*, which we discussed at length in SECTION 1.2 (see page 102). Java's convention that all objects inherit an `equals()` method and its implementation of `equals()` both for standard types such as `Integer`, `Double`, and `String` and for more complicated types such as `File` and `URL` is a head start—when using these types of data, you can just use the built-in implementation. For example, if `x` and `y` are `String` values, then `x.equals(y)` is `true` if and only if `x` and `y` have the same length and are identical in each character position. For such client-defined keys, you need to override `equals()`, as discussed in SECTION 1.2. You can use our implementation of `equals()` for `Date` (page 103) as a template to develop `equals()` for a type of your own. As discussed for priority queues on page 320, a best practice is to make `Key` types immutable, because consistency cannot otherwise be guaranteed.

Ordered symbol tables In typical applications, keys are `Comparable` objects, so the option exists of using the code `a.compareTo(b)` to compare two keys `a` and `b`. Several symbol-table implementations take advantage of order among the keys that is implied by `Comparable` to provide efficient implementations of the `put()` and `get()` operations. More important, in such implementations, we can think of the symbol table as *keeping the keys in order* and consider a significantly expanded API that defines numerous natural and useful operations involving relative key order. For example, suppose that your keys are times of the day. You might be interested in knowing the earliest or the latest time, the set of keys that fall between two given times, and so forth. In most cases, such operations are not difficult to implement with the same data structures and methods underlying the `put()` and `get()` implementations. Specifically, for applications where keys are `Comparable`, we implement in this chapter the following API:

<code>public class ST<Key extends Comparable<Key>, Value></code>	
<code>ST()</code>	<i>create an ordered symbol table</i>
<code>void put(Key key, Value val)</code>	<i>put key-value pair into the table (remove key from table if value is null)</i>
<code>Value get(Key key)</code>	<i>value paired with key (null if key is absent)</i>
<code>void delete(Key key)</code>	<i>remove key (and its value) from table</i>
<code>boolean contains(Key key)</code>	<i>is there a value paired with key?</i>
<code>boolean isEmpty()</code>	<i>is the table empty?</i>
<code>int size()</code>	<i>number of key-value pairs</i>
<code>Key min()</code>	<i>smallest key</i>
<code>Key max()</code>	<i>largest key</i>
<code>Key floor(Key key)</code>	<i>largest key less than or equal to key</i>
<code>Key ceiling(Key key)</code>	<i>smallest key greater than or equal to key</i>
<code>int rank(Key key)</code>	<i>number of keys less than key</i>
<code>Key select(int k)</code>	<i>key of rank k</i>
<code>void deleteMin()</code>	<i>delete smallest key</i>
<code>void deleteMax()</code>	<i>delete largest key</i>
<code>int size(Key lo, Key hi)</code>	<i>number of keys in [lo..hi]</i>
<code>Iterable<Key> keys(Key lo, Key hi)</code>	<i>keys in [lo..hi], in sorted order</i>
<code>Iterable<Key> keys()</code>	<i>all keys in the table, in sorted order</i>

API for a generic ordered symbol table

Your signal that one of our programs is implementing this API is the presence of the `Key` extends `Comparable<Key>` generic type variable in the class declaration, which specifies that the code depends upon the keys being `Comparable` and implements the richer set of operations. Together, these operations define for client programs an *ordered symbol table*.

Minimum and maximum. Perhaps the most natural queries for a set of ordered keys are to ask for the smallest and largest keys. We have already encountered these operations, in our discussion of priority queues in SECTION 2.4. In ordered symbol tables, we also have methods to delete the maximum and minimum keys (and their associated values). With this capability, the symbol table can operate like the `IndexMinPQ()` class that we discussed in SECTION 2.4. The primary differences are that equal keys are allowed in priority queues but not in symbol tables and that ordered symbol tables support a much larger set of operations.

Floor and ceiling. Given a key, it is often useful to be able to perform the *floor* operation (find the largest key that is less than or equal to the given key) and the *ceiling* operation (find the smallest key that is greater than or equal to the given key). The nomenclature comes from functions defined on real numbers (the floor of a real number x is the largest integer that is smaller than or equal to x and the ceiling of a real number x is the smallest integer that is greater than or equal to x).

Rank and selection. The basic operations for determining where a new key fits in the order are the *rank* operation (find the number of keys less than a given key) and the *select* operation (find the key with a given rank). To test your understanding of their meaning, confirm for yourself that both $i == \text{rank}(\text{select}(i))$ for all i between 0 and `size()`-1 and all keys in the table satisfy $\text{key} == \text{select}(\text{rank}(\text{key}))$. We have already encountered the need for these operations, in our discussion of sort applications in SECTION 2.5. For symbol tables, our challenge is to perform these operations quickly, intermixed with insertions, deletions, and searches.

	<i>keys</i>	<i>values</i>
<code>min()</code> →	09:00:00	Chicago
	09:00:03	Phoenix
	09:00:13 →	Houston
<code>get(09:00:13)</code> →	09:00:59	Chicago
	09:01:10	Houston
<code>floor(09:05:00)</code> →	09:03:13	Chicago
	09:10:11	Seattle
<code>select(7)</code> →	09:10:25	Seattle
	09:14:25	Phoenix
	09:19:32	Chicago
	09:19:46	Chicago
<code>keys(09:15:00, 09:25:00)</code> →	09:21:05	Chicago
	09:22:43	Seattle
	09:22:54	Seattle
	09:25:52	Chicago
<code>ceiling(09:30:00)</code> →	09:35:21	Chicago
	09:36:14	Seattle
<code>max()</code> →	09:37:44	Phoenix

`size(09:15:00, 09:25:00) is 5`
`rank(09:10:25) is 7`

Examples of ordered symbol-table operations

Range queries. How many keys fall within a given range (between two given keys)? Which keys fall in a given range? The two-argument `size()` and `keys()` methods that answer these questions are useful in many applications, particularly in large databases. The capability to handle such queries is one prime reason that ordered symbol tables are so widely used in practice.

Exceptional cases. When a method is to return a key and there is no key fitting the description in the table, our convention is to throw an exception (an alternate approach, which is also reasonable, would be to return `null` in such cases). For example, `min()`, `max()`, `deleteMin()`, `deleteMax()`, `floor()`, and `ceiling()` all throw exceptions if the table is empty, as does `select(k)` if `k` is less than 0 or not less than `size()`.

Shorthand methods. As we have already seen with `isEmpty()` and `contains()` in our basic API, we keep some redundant methods in the API for clarity in client code. For economy in the text, we assume that the following default implementations are included in any implementation of the ordered symbol-table API unless otherwise specified:

method	default implementation
<code>void deleteMin()</code>	<code>delete(min());</code>
<code>void deleteMax()</code>	<code>delete(max());</code>
<code>int size(Key lo, Key hi)</code>	<pre> if (hi.compareTo(lo) < 0) return 0; else if (contains(hi)) return rank(hi) - rank(lo) + 1; else return rank(hi) - rank(lo); </pre>
<code>Iterable<Key> keys()</code>	<code>return keys(min(), max());</code>

Default implementations of redundant order-based symbol-table methods

Key equality (revisited). The best practice in Java is to make `compareTo()` consistent with `equals()` in all `Comparable` types. That is, for every pair of values `a` and `b` in any given `Comparable` type, it should be the case that `(a.compareTo(b) == 0)` and `a.equals(b)` have the same value. To avoid any potential ambiguities, we avoid the use of `equals()` in ordered symbol-table implementations. Instead, we use `compareTo()` exclusively to compare keys: we take the boolean expression `a.compareTo(b) == 0` to

mean “Are *a* and *b* equal?” Typically, such a test marks the successful end of a search for *a* in the symbol table (by finding *b*). As you saw with sorting algorithms, Java provides standard implementations of `compareTo()` for many commonly used types of keys, and it is not difficult to develop a `compareTo()` implementation for your own data types (see SECTION 2.5).

Cost model. Whether we use `equals()` (for symbol tables where keys are not `Comparable`) or `compareTo()` (for ordered symbol tables with `Comparable` keys), we use the term *compare* to refer to the operation of comparing a symbol-table entry against a search key. In most symbol-table implementations, this operation is in the inner loop. In the few cases where that is not the case, we also count array accesses.

SYMBOL-TABLE IMPLEMENTATIONS are generally characterized by their underlying data structures and their implementations of `get()` and `put()`. We do not always provide implementations of all of the other methods in the text because many of them make good exercises to test your understanding of the underlying data structures. To distinguish implementations, we add a descriptive prefix to ST that refers to the implementation in the class name of symbol-table implementations. In clients, we use ST to call on a reference implementation unless we wish to refer to a specific implementation. You will gradually develop a better feeling for the rationale behind the methods in the APIs in the context of the numerous clients and symbol-table implementations that we present and discuss throughout this chapter and throughout the rest of this book. We also discuss alternatives to the various design choices that we have described here in the Q&A and exercises.

Searching cost model.

When studying symbol-table implementations, we count *compares* (equality tests or key comparisons). In (rare) cases where *compares* are not in the inner loop, we count *array accesses*.

Sample clients While we defer detailed consideration of applications to SECTION 3.5, it is worthwhile to consider some client code before considering implementations. Accordingly, we now consider two clients: a test client that we use to trace algorithm behavior on small inputs and a performance client that we use to motivate the development of efficient implementations.

Test client. For tracing our algorithms on small inputs we assume that all of our implementations use the test client below, which takes a sequence of strings from standard input, builds a symbol table that associates the value i with the i th string in the input, and then prints the table. In the traces in the text, we assume that the input is a sequence

```
public static void main(String[] args)
{
    ST<String, Integer> st;
    st = new ST<String, Integer>();
    for (int i = 0; !StdIn.isEmpty(); i++)
    {
        String key = StdIn.readString();
        st.put(key, i);
    }
    for (String s : st.keys())
        StdOut.println(s + " " + st.get(s));
}
```

Basic symbol-table test client

keys	S	E	A	R	C	H	E	X	A	M	P	L	E
values	0	1	2	3	4	5	6	7	8	9	10	11	12

output for basic symbol table (one possibility)	output for ordered symbol table
L 11	A 8
P 10	C 4
M 9	E 12
X 7	H 5
H 5	L 11
C 4	M 9
R 3	P 10
A 8	R 3
E 12	S 0
S 0	X 7

Keys, values, and output for test client

of single-character strings. Most often, we use the string "S E A R C H E X A M P L E". By our conventions, this client associates the key S with the value 0, the key R with the value 3, and so forth. But E is associated with the value 12 (not 1 or 6) and A with the value 8 (not 2) because our associative-array convention implies that each key is associated with the value used in the most recent call to `put()`. For basic (unordered) implementations, the order of the keys in the output of this test client is not specified (it depends on characteristics of the implementation); for an ordered symbol table the test client prints the keys in sorted order. This client is an example of an *indexing* client, a special case of a fundamental symbol-table application that we discuss in SECTION 3.5.

Performance client. `FrequencyCounter` (on the next page) is a symbol-table client that finds the number of occurrences of each string (having at least as many characters as a given threshold length) in a sequence of strings from standard input, then iterates through the keys to find the one that occurs the most frequently. This client is an example of a *dictionary* client, an application that we discuss in more detail in SECTION 3.5. This client answers a simple question: Which word (no shorter than a given length) occurs most frequently in a given text? Throughout this chapter, we measure performance of this client with three reference inputs: the first five lines of C. Dickens's *Tale of Two Cities* (`tinyTale.txt`), the full text of the book (`tale.txt`), and a popular database of 1 million sentences taken at random from the web that is known as the *Leipzig Corpora Collection* (`leipzig1M.txt`). For example, here is the content of `tinyTale.txt`:

```
% more tinyTale.txt
it was the best of times it was the worst of times
it was the age of wisdom it was the age of foolishness
it was the epoch of belief it was the epoch of incredulity
it was the season of light it was the season of darkness
it was the spring of hope it was the winter of despair
```

Small test input

This text has 60 words taken from 20 distinct words, four of which occur ten times (the highest frequency). Given this input, `FrequencyCounter` will print out any of `i`, `t`, `was`, `the`, or `of` (the one chosen may vary, depending upon characteristics of the symbol-table implementation), followed by the frequency, 10.

To study performance for the larger inputs, it is clear that two measures are of interest: Each word in the input is used as a search key once, so the total number of words in the text is certainly relevant. Second, each *distinct* word in the input is put into the

	tinyTale.txt		tale.txt		leipzig1M.txt	
	words	distinct	words	distinct	words	distinct
all words	60	20	135,635	10,679	21,191,455	534,580
at least 8 letters	3	3	14,350	5,737	4,239,597	299,593
at least 10 letters	2	2	4,582	2,260	1,610,829	165,555

Characteristics of larger test input streams

A symbol-table client

```
public class FrequencyCounter
{
    public static void main(String[] args)
    {
        int minlen = Integer.parseInt(args[0]); // key-length cutoff
        ST<String, Integer> st = new ST<String, Integer>();
        while (!StdIn.isEmpty())
        { // Build symbol table and count frequencies.
            String word = StdIn.readString();
            if (word.length() < minlen) continue; // Ignore short keys.
            if (!st.contains(word)) st.put(word, 1);
            else
                st.put(word, st.get(word) + 1);
        }
        // Find a key with the highest frequency count.
        String max = "";
        st.put(max, 0);
        for (String word : st.keys())
            if (st.get(word) > st.get(max))
                max = word;
        StdOut.println(max + " " + st.get(max));
    }
}
```

This ST client counts the frequency of occurrence of the strings in standard input, then prints out one that occurs with highest frequency. The command-line argument specifies a lower bound on the length of keys considered.

```
% java FrequencyCounter 1 < tinyTale.txt
it 10

% java FrequencyCounter 8 < tale.txt
business 122

% java FrequencyCounter 10 < leipzig1M.txt
government 24763
```

symbol table (and the total number of distinct words in the input gives the size of the table after all keys have been inserted), so the total number of distinct words in the input stream is certainly relevant. We need to know both of these quantities in order to estimate the running time of `FrequencyCounter` (for a start, see EXERCISE 3.1.6). We defer details until we consider some algorithms, but you should have in mind a general idea of the needs of typical applications like this one. For example, running `FrequencyCounter` on `leipzig1M.txt` for words of length 8 or more involves millions of searches in a table with hundreds of thousands of keys and values. A server on the web might need to handle billions of transactions on tables with millions of keys and values.

THE BASIC QUESTION THAT THIS CLIENT and these examples raise is the following: Can we develop a symbol-table implementation that can handle a huge number of `get()` operations on a large table, which itself was built with a large number of intermixed `get()` and `put()` operations? If you are only doing a few searches, any implementation will do, but you cannot make use of a client like `FrequencyCounter` for large problems without a good symbol-table implementation. `FrequencyCounter` is surrogate for a very common situation. Specifically, it has the following characteristics, which are shared by many other symbol-table clients:

- Search and insert operations are intermixed.
- The number of distinct keys is not small.
- Substantially more searches than inserts are likely.
- Search and insert patterns, though unpredictable, are not random.

Our goal is to develop symbol-table implementations that make it feasible to use such clients to solve typical practical problems.

Next, we consider two elementary implementations and their performance for `FrequencyCounter`. Then, in the next several sections, you will learn classic implementations that can achieve excellent performance for such clients, even for huge input streams and tables.

Sequential search in an unordered linked list One straightforward option for the underlying data structure for a symbol table is a linked list of nodes that contain keys and values, as in the code on the facing page. To implement `get()`, we scan through the list, using `equals()` to compare the search key with the key in each node in the list. If we find the match, we return the associated value; if not, we return `null`. To implement `put()`, we also scan through the list, using `equals()` to compare the client key with the key in each node in the list. If we find the match, we update the value associated with that key to be the value given in the second argument; if not, we create a new node with the given key and value and insert it at the beginning of the list. This method is known as *sequential search*: we search by considering the keys in the table one after another, using `equals()` to test for a match with our search key.

ALGORITHM 3.1 (`SequentialSearchST`) is an implementation of our basic symbol-table API that uses standard list-processing mechanisms, which we have used for elementary data structures in CHAPTER 1. We have left the implementations of `size()`, `keys()`, and `eager delete()` for exercises. You are encouraged to work these exercises to cement your understanding of the linked-list data structure and the basic symbol-table API.

Can this linked-list-based implementation handle applications that need large tables, such as our sample clients? As we have noted, analyzing symbol-table algorithms is more complicated than analyzing sorting algorithms because of the difficulty of

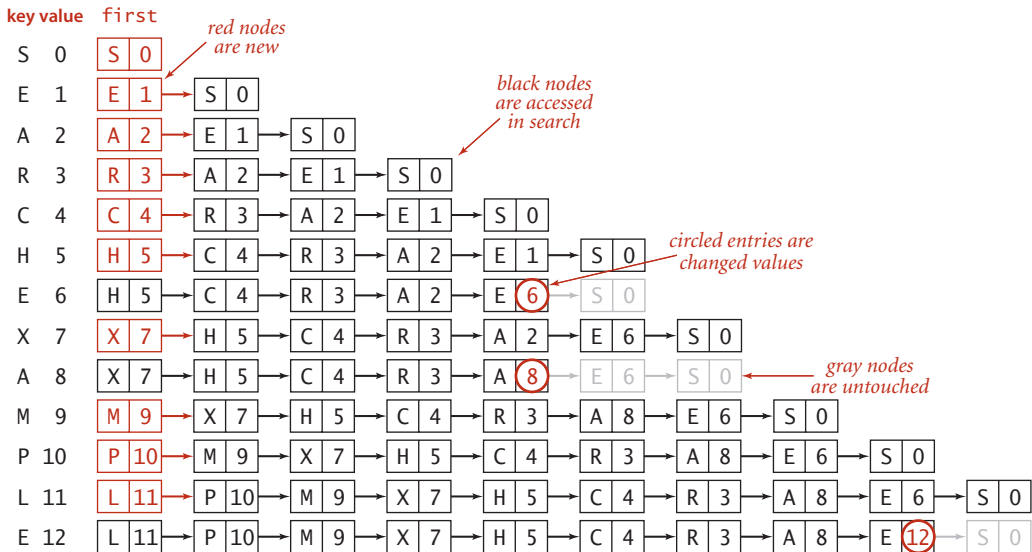

Trace of linked-list ST implementation for standard indexing client

ALGORITHM 3.1 Sequential search (in an unordered linked list)

```
public class SequentialSearchST<Key, Value>
{
    private Node first;           // first node in the linked list

    private class Node
    { // linked-list node
        Key key;
        Value val;
        Node next;
        public Node(Key key, Value val, Node next)
        {
            this.key = key;
            this.val = val;
            this.next = next;
        }
    }

    public Value get(Key key)
    { // Search for key, return associated value.
        for (Node x = first; x != null; x = x.next)
            if (key.equals(x.key))
                return x.val; // search hit
        return null; // search miss
    }

    public void put(Key key, Value val)
    { // Search for key. Update value if found; grow table if new.
        for (Node x = first; x != null; x = x.next)
            if (key.equals(x.key))
                { x.val = val; return; } // Search hit: update val.
        first = new Node(key, val, first); // Search miss: add new node.
    }
}
```

This ST implementation uses a private `Node` inner class to keep the keys and values in an unordered linked list. The `get()` implementation searches the list sequentially to find whether the key is in the table (and returns the associated value if so). The `put()` implementation also searches the list sequentially to check whether the key is in the table. If so, it updates the associated value; if not, it creates a new node with the given key and value and inserts it at the beginning of the list. Implementations of `size()`, `keys()`, and eager `delete()` are left for exercises.

characterizing the sequence of operations that might be invoked by a given client. As noted for `FrequencyCounter`, the most common situation is that, while search and insert patterns are unpredictable, they certainly are not random. For this reason, we pay careful attention to worst-case performance. For economy, we use the term *search hit* to refer to a successful search and *search miss* to refer to an unsuccessful search.

Proposition A. Search misses and insertions in an (unordered) linked-list symbol table having N key-value pairs both require N compares, and search hits N compares in the worst case. In particular, inserting N distinct keys into an initially empty linked-list symbol table uses $\sim N^2/2$ compares.

Proof: When searching for a key that is not in the list, we test every key in the table against the search key. Because of our policy of disallowing duplicate keys, we need to do such a search before each insertion.

Corollary. Inserting N distinct keys into an initially empty linked-list symbol table uses $\sim N^2/2$ compares.

It is true that searches for keys that are *in* the table need not take linear time. One useful measure is to compute the total cost of searching for all of the keys in the table, divided by N . This quantity is precisely the expected number of compares required for a search under the condition that searches for each key in the table are equally likely. We refer to such a search as a *random search hit*. Though client search patterns are not likely to be random, they often are well-described by this model. It is easy to show that the average number of compares for a random search hit is $\sim N/2$: the `get()` method in ALGORITHM 3.1 uses 1 compare to find the first key, 2 compares to find the second key, and so forth, for an average cost of $(1 + 2 + \dots + N)/N = (N + 1)/2 \sim N/2$.

This analysis strongly indicates that a linked-list implementation with sequential search is too slow for it to be used to solve huge problems such as our reference inputs with clients like `FrequencyCounter`. The total number of compares is proportional to the product of the number of searches and the number of inserts, which is more than 10^9 for *Tale of Two Cities* and more than 10^{14} for the Leipzig Corpora.

As usual, to validate analytic results, we need to run experiments. As an example, we study the operation of `FrequencyCounter` with command-line argument 8 for `ta1e.txt`, which involves 14,350 `put()` operations (recall that every word in the input leads to a `put()`), to update its frequency, and we ignore the cost of easily avoided calls

to `contains()`). The symbol table grows to 5,737 keys, so about one-third of the operations increase the size of the table; the rest are searches. To visualize the performance, we use `VisualAccumulator` (see page 95) to plot two points corresponding to each `put()` operation as follows: for the i th `put()` operation we plot a gray point with x coordinate i and y coordinate the number of key compares it uses and a red point with x coordinate i and y coordinate the cumulative average number of key compares used for the first i `put()` operations. As with any scientific data, there is a great deal of information in this data for us to investigate (this plot has 14,350 gray points and 14,350 red points). In this context, our primary interest is that the plot validates our hypothesis that about half the list is accessed for the average `put()` operation. The actual total is slightly lower than half, but this fact (and the precise shape of the curves) is perhaps best explained by characteristics of the application, not our algorithms (see EXERCISE 3.1.36).

While detailed characterization of performance for particular clients can be complicated, specific hypotheses are easy to formulate and to test for `FrequencyCount` with our reference inputs or with randomly ordered inputs, using a client like the `DoublingTest` client that we introduced in CHAPTER 1. We will reserve such testing for exercises and for the more sophisticated implementations that follow. If you are not already convinced that we need faster implementations, be sure to work these exercises (or just run `FrequencyCounter` with `SequentialSearchST` on `leipzig1M.txt`!).

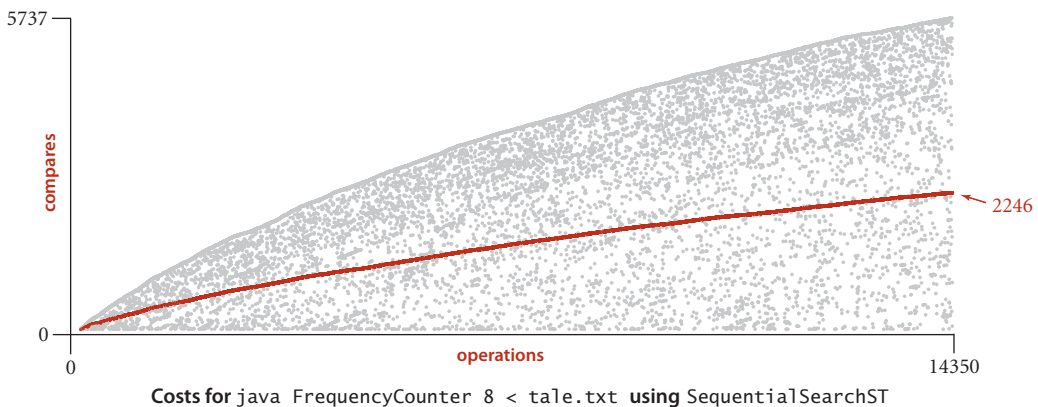

Binary search in an ordered array Next, we consider a full implementation of our ordered symbol-table API. The underlying data structure is a pair of parallel arrays, one for the keys and one for the values. ALGORITHM 3.2 (BinarySearchST) on the facing page keeps Comparable keys in order in the array, then uses array indexing to enable fast implementation of get() and other operations.

The heart of the implementation is the rank() method, which returns the number of keys smaller than a given key. For get(), the rank tells us precisely where the key is to be found if it is in the table (and, if it is not there, that it is *not* in the table).

For put(), the rank tells us precisely where to update the value when the key is in the table, and precisely where to put the key when the key is not in the table. We move all larger keys over one position to make room (working from back to front) and insert the given key and value into the proper positions in their respective arrays. Again, studying BinarySearchST in conjunction with a trace of our test client is an instructive introduction to this data structure.

This code maintains parallel arrays of keys and values (see EXERCISE 3.1.12 for an alternative). As with our implementations of generic stacks and queues in CHAPTER 1, this code carries the inconvenience of having to create a Key array of type Comparable and a Value array of type Object, and to cast them back to Key[] and Value[] in the constructor. As usual, we can use array resizing so that clients do not have to be concerned with the size of the array (noting, as you shall see, that this method is too slow to use with large arrays).

		keys[]											vals[]									
key	value	0	1	2	3	4	5	6	7	8	9	N	0	1	2	3	4	5	6	7	8	9
S	0	S										1	0									
E	1	E	S									2	1	0								
A	2	A	E	S								3	2	1	0							
R	3	A	E	R	S							4	2	1	3	0						
C	4	A	C	E	R	S						5	2	4	1	3	0					
H	5	A	C	E	H	R	S					6	2	4	1	5	3	0				
E	6	A	C	E	H	R	S					6	2	4	6	5	3	0				
X	7	A	C	E	H	R	S	X				7	2	4	6	5	3	0	7			
A	8	A	C	E	H	R	S	X				7	8	4	6	5	3	0	7			
M	9	A	C	E	H	M	R	S	X			8	8	4	6	5	9	3	0	7		
P	10	A	C	E	H	M	P	R	S	X		9	8	4	6	5	9	10	3	0	7	
L	11	A	C	E	H	L	M	P	R	S	X	10	8	4	6	5	11	9	10	3	0	7
E	12	A	C	E	H	L	M	P	R	S	X	10	8	4	12	5	11	9	10	3	0	7
		A	C	E	H	L	M	P	R	S	X		8	4	12	5	11	9	10	3	0	7

Trace of ordered-array ST implementation for standard indexing client

ALGORITHM 3.2 Binary search (in an ordered array)

```

public class BinarySearchST<Key extends Comparable<Key>, Value>
{
    private Key[] keys;
    private Value[] vals;
    private int N;

    public BinarySearchST(int capacity)
    { // See Algorithm 1.1 for standard array-resizing code.
        keys = (Key[]) new Comparable[capacity];
        vals = (Value[]) new Object[capacity];
    }

    public int size()
    { return N; }

    public Value get(Key key)
    {
        if (isEmpty()) return null;
        int i = rank(key);
        if (i < N && keys[i].compareTo(key) == 0) return vals[i];
        else return null;
    }

    public int rank(Key key)
    // See page 381.

    public void put(Key key, Value val)
    { // Search for key. Update value if found; grow table if new.
        int i = rank(key);
        if (i < N && keys[i].compareTo(key) == 0)
        { vals[i] = val; return; }
        for (int j = N; j > i; j--)
        { keys[j] = keys[j-1]; vals[j] = vals[j-1]; }
        keys[i] = key; vals[i] = val;
        N++;
    }

    public void delete(Key key)
    // See Exercise 3.1.16 for this method.
}

```

This ST implementation keeps the keys and values in parallel arrays. The `put()` implementation moves larger keys one position to the right before growing the table as in the array-based stack implementation in SECTION 1.3. Array-resizing code is omitted here.

Binary search. The reason that we keep keys in an ordered array is so that we can use array indexing to dramatically reduce the number of compares required for each search, using the classic and venerable *binary search* algorithm that we used as an example in CHAPTER 1. We maintain indices into the sorted key array that delimit the subarray that might contain the search key. To search, we compare the search key against the key in the middle of the subarray. If the search key is less than the key in the middle, we search in the left half of the subarray; if the search key is greater than the key in the middle, we search in the right half of the subarray; otherwise the key in the middle is equal to the search key. The `rank()` code on the facing page uses binary search to complete the symbol-table implementation just discussed. This implementation is worthy of careful study. To study it, we start with the equivalent recursive code at left. A call to `rank(key, 0, N-1)` does the same sequence of compares as a call to the nonrecursive implementation in ALGORITHM 3.2, but this alternate version better exposes the structure of the algorithm, as discussed in SECTION 1.1. This recursive `rank()` preserves the following properties:

```
public int rank(Key key, int lo, int hi)
{
    if (hi < lo) return lo;
    int mid = lo + (hi - lo) / 2;
    int cmp = key.compareTo(keys[mid]);
    if (cmp < 0)
        return rank(key, lo, mid-1);
    else if (cmp > 0)
        return rank(key, mid+1, hi);
    else return mid;
}
```

Recursive binary search

- If key is in the table, `rank()` returns its index in the table, which is the same as the number of keys in the table that are smaller than key.
- If key is not in the table, `rank()` *also* returns the number of keys in the table that are smaller than key.

Taking the time to convince yourself that the nonrecursive `rank()` in ALGORITHM 3.2 operates as expected (either by proving that it is equivalent to the recursive version or by proving directly that the loop always terminates with the value of `lo` precisely equal to the number of keys in the table that are smaller than key) is a worthwhile exercise for any programmer. (*Hint*: Note that `lo` starts at 0 and never decreases.)

Other operations. Since the keys are kept in an ordered array, most of the order-based operations are compact and straightforward, as you can see from the code on page 382. For example, a call to `select(k)` just returns `keys[k]`. We have left `delete()` and `floor()` as exercises. You are encouraged to study the implementation of `ceiling()` and the two-argument `keys()` and to work these exercises to cement your understanding of the ordered symbol-table API and this implementation.

ALGORITHM 3.2 (continued) Binary search in an ordered array (iterative)

```

public int rank(Key key)
{
    int lo = 0, hi = N-1;
    while (lo <= hi)
    {
        int mid = lo + (hi - lo) / 2;
        int cmp = key.compareTo(keys[mid]);
        if (cmp < 0) hi = mid - 1;
        else if (cmp > 0) lo = mid + 1;
        else return mid;
    }
    return lo;
}

```

This method uses the classic method described in the text to compute the number of keys in the table that are smaller than key. Compare key with the key in the middle: if it is equal, return its index; if it is less, look in the left half; if it is greater, look in the right half.

		keys[]									
		0	1	2	3	4	5	6	7	8	9
successful search for P											
	lo hi mid										
	0 9 4	A	C	E	H	L	M	P	R	S	X
	5 9 7	A	C	E	H	L	M	P	R	S	X
	5 6 5	A	C	E	H	L	M	P	R	S	X
	6 6 6	A	C	E	H	L	M	P	R	S	X
unsuccessful search for Q											
	lo hi mid										
	0 9 4	A	C	E	H	L	M	P	R	S	X
	5 9 7	A	C	E	H	L	M	P	R	S	X
	5 6 5	A	C	E	H	L	M	P	R	S	X
	7 6 6	A	C	E	H	L	M	P	R	S	X

entries in black are a[lo..hi]
entry in red is a[mid]
loop exits with keys[mid] = P: return
loop exits with lo > hi: return 7

Trace of binary search for rank in an ordered array

ALGORITHM 3.2 (continued) Ordered symbol-table operations for binary search

```
public Key min()
{ return keys[0]; }

public Key max()
{ return keys[N-1]; }

public Key select(int k)
{ return keys[k]; }

public Key ceiling(Key key)
{
    int i = rank(key);
    return keys[i];
}

public Key floor(Key key)
// See Exercise 3.1.17.

public Key delete(Key key)
// See Exercise 3.1.16.

public Iterable<Key> keys(Key lo, Key hi)
{
    Queue<Key> q = new Queue<Key>();
    for (int i = rank(lo); i < rank(hi); i++)
        q.enqueue(keys[i]);
    if (contains(hi))
        q.enqueue(keys[rank(hi)]);
    return q;
}
```

These methods, along with the methods of EXERCISE 3.1.16 and EXERCISE 3.1.17, complete the implementation of our (ordered) symbol-table API using binary search in an ordered array. The `min()`, `max()`, and `select()` methods are trivial, just amounting to returning the appropriate key from its known position in the array. The `rank()` method, which is the basis of binary search, plays a central role in the others. The `floor()` and `delete()` implementations, left for exercises, are more complicated, but still straightforward.

Analysis of binary search The recursive implementation of `rank()` also leads to an immediate argument that binary search guarantees fast search, because it corresponds to a recurrence relation that describes an upper bound on the number of compares.

Proposition B. Binary search in an ordered array with N keys uses no more than $\lg N + 1$ compares for a search (successful or unsuccessful).

Proof: This analysis is similar to (but simpler than) the analysis of mergesort (PROPOSITION F in CHAPTER 2). Let $C(N)$ be the number of compares needed to search for a key in a symbol table of size N . We have $C(0) = 0$, $C(1) = 1$, and for $N > 0$ we can write a recurrence relationship that directly mirrors the recursive method:

$$C(N) \leq C(\lfloor N/2 \rfloor) + 1$$

Whether the search goes to the left or to the right, the size of the subarray is no more than $\lfloor N/2 \rfloor$, and we use one compare to check for equality and to choose whether to go left or right. When N is one less than a power of 2 (say $N = 2^n - 1$), this recurrence is not difficult to solve. First, since $\lfloor N/2 \rfloor = 2^{n-1} - 1$, we have

$$C(2^n - 1) \leq C(2^{n-1} - 1) + 1$$

Applying the same equation to the first term on the right, we have

$$C(2^n - 1) \leq C(2^{n-2} - 1) + 1 + 1$$

Repeating the previous step $n - 2$ additional times gives

$$C(2^n - 1) \leq C(2^0) + n$$

which leaves us with the solution

$$C(N) = C(2^n) \leq n + 1 < \lg N + 1$$

Exact solutions for general N are more complicated, but it is not difficult to extend this argument to establish the stated property for all values of N (see EXERCISE 3.1.20). With binary search, we achieve a logarithmic-time search guarantee.

The implementation just given for `ceiling()` is based on a single call to `rank()`, and the default two-argument `size()` implementation calls `rank()` twice, so this proof also establishes that these operations (and `floor()`) are supported in guaranteed logarithmic time (`min()`, `max()`, and `select()` are constant-time operations).

method	order of growth of running time
put()	N
get()	$\log N$
delete()	N
contains()	$\log N$
size()	1
min()	1
max()	1
floor()	$\log N$
ceiling()	$\log N$
rank()	$\log N$
select()	1
deleteMin()	N
deleteMax()	1

Despite its guaranteed logarithmic search, BinarySearchST still does not enable us to use clients like FrequencyCounter to solve huge problems, because the put() method is too slow. Binary search reduces the number of compares, but not the running time, because its use does not change the fact that the number of array accesses required to build a symbol table in an ordered array is quadratic in the size of the array when keys are randomly ordered (and in typical practical situations where the keys, while not random, are well-described by this model).

Proposition B (continued). Inserting a new key into an ordered array of size N uses $\sim 2N$ array accesses in the worst case, so inserting N keys into an initially empty table uses $\sim N^2$ array accesses in the worst case.

Proof: Same as for PROPOSITION A.

BinarySearchST costs

For *Tale of Two Cities*, with over 10^4 distinct keys, the cost to build the table is nearly 10^8 array accesses, and for the Leipzig project, with over 10^6 distinct keys, the cost to build the table is over 10^{11} array accesses. While not quite prohibitive on modern computers, these costs are extremely (and unnecessarily) high.

Returning to the cost of the put() operations for FrequencyCounter for words of length 8 or more, we see a reduction in the average cost from 2,246 compares (plus array accesses) per operation for SequentialSearchST to 484 for BinarySearchST. As before, this cost is even better than would be predicted by analysis, and the extra improvement is likely again explained by properties of the application (see EXERCISE 3.1.36). This improvement is impressive, but we can do much better, as you shall see.

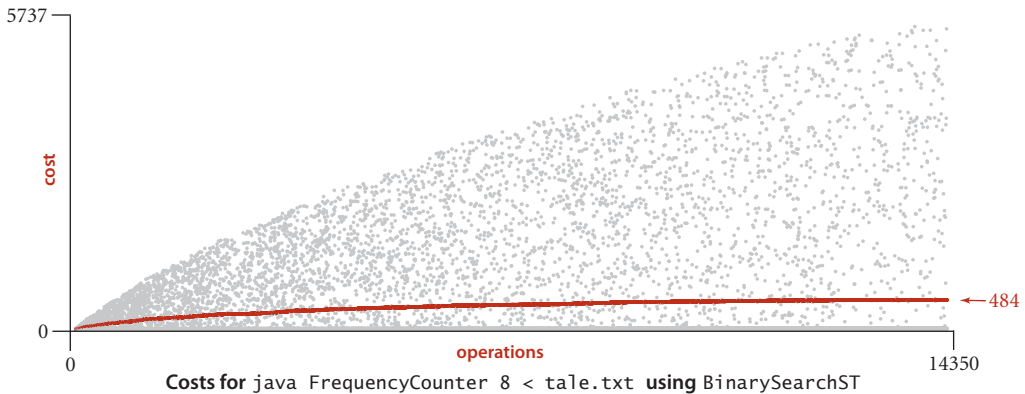

Preview Binary search is typically far better than sequential search and is the method of choice in numerous practical applications. For a static table (with no insert operations allowed), it is worthwhile to initialize and sort the table, as in the version of binary search that we considered in CHAPTER 1 (see page 99). Even when the bulk of the key-value pairs is known before the bulk of the searches (a common situation in applications), it is worthwhile to add to `BinarySearchST` a constructor that initializes and sorts the table (see EXERCISE 3.1.12). Still, binary search is infeasible for use in many other applications. For example, it fails for our Leipzig Corpora application because searches and inserts are intermixed and the table size is too large. As we have emphasized, typical modern search clients require symbol tables that can support fast implementations of *both* search and insert. That is, we need to be able to build huge tables where we can insert (and perhaps remove) key-value pairs in unpredictable patterns, intermixed with searches.

The table below summarizes performance characteristics for the elementary symbol-table implementations considered in this section. The table entries give the leading term of the cost (number of array accesses for binary search, number of compares for the others), which implies the order of growth of the running time.

algorithm (data structure)	worst-case cost (after N inserts)		average-case cost (after N random inserts)		efficiently support ordered operations?
	search	insert	search hit	insert	
<i>sequential search</i> (<i>unordered linked list</i>)	N	N	$N/2$	N	no
<i>binary search</i> (<i>ordered array</i>)	$\lg N$	$2N$	$\lg N$	N	yes

Cost summary for basic symbol-table implementations

The central question is whether we can devise algorithms and data structures that achieve logarithmic performance for *both* search and insert. The answer is a resounding *yes!* Providing that answer is the main thrust of this chapter. Along with the fast sort capability discussed in CHAPTER 2, fast symbol-table search/insert is one of the most important contributions of algorithmics and one of the most important steps toward the development of the rich computational infrastructure that we now enjoy.

How can we achieve this goal? To support efficient insertion, it seems that we need a linked structure. But a singly linked list forecloses the use of binary search, because the efficiency of binary search depends on our ability to get to the middle of any subarray

quickly via indexing (and the only way to get to the middle of a singly linked list is to follow links). To combine the efficiency of binary search with the flexibility of linked structures, we need more complicated data structures. That combination is provided both by *binary search trees*, the subject of the next two sections, and by *hash tables*, the subject of SECTION 3.4.

We consider six symbol-table implementations in this chapter, so a brief preview is in order. The table below is a list of the data structures, along with the primary reasons in favor of and against using each for an application. They appear in the order in which we consider them.

We will get into more detail on properties of the algorithms and implementations as we discuss them, but the brief characterizations in this table will help you keep them in a broader context as you learn them. The bottom line is that we have several fast symbol-table implementations that can be and are used to great effect in countless applications.

underlying data structure	implementation	pros	cons
<i>linked list (sequential search)</i>	SequentialSearchST	best for tiny STs	slow for large STs
<i>ordered array (binary search)</i>	BinarySearchST	optimal search and space, order-based ops	slow insert
<i>binary search tree</i>	BST	easy to implement, order-based ops	no guarantees space for links
<i>balanced BST</i>	RedBlackBST	optimal search and insert, order-based ops	space for links
<i>hash table</i>	SeparateChainingHashST LinearProbingHashST	fast search/insert for common types of data	need hash for each type no order-based ops space for links/empty

Pros and cons of symbol-table implementations

Q&A

Q. Why not use an `Item` type that implements `Comparable` for symbol tables, in the same way as we did for priority queues in SECTION 2.4, instead of having separate keys and values?

A. That is also a reasonable option. These two approaches illustrate two different ways to associate information with keys—we can do so *implicitly* by building a data type that includes the key or *explicitly* by separating keys from values. For symbol tables, we have chosen to highlight the associative array abstraction. Note also that a client specifies just a key in search, not a key-value aggregation.

Q. Why bother with `equals()`? Why not just use `compareTo()` throughout?

A. Not all data types lead to key values that are easy to compare, even though having a symbol table still might make sense. To take an extreme example, you may wish to use pictures or songs as keys. There is no natural way to compare them, but we can certainly test equality (with some work).

Q. Why not allow keys to take the value `null`?

A. We assume that `Key` is an `Object` because we use it to invoke `compareTo()` or `equals()`. But a call like `a.compareTo(b)` would cause a null pointer exception if `a` is `null`. By ruling out this possibility, we allow for simpler client code.

Q. Why not use a method like the `less()` method that we used for sorting?

A. Equality plays a special role in symbol tables, so we also would need a method for testing equality. To avoid proliferation of methods that have essentially the same function, we adopt the built-in Java methods `equals()` and `compareTo()`.

Q. Why not declare `key[]` as `Object[]` (instead of `Comparable[]`) in `BinarySearchST` before casting, in the same way that `val[]` is declared as `Object`?

A. Good question. If you do so, you will get a `ClassCastException` because keys need to be `Comparable` (to ensure that entries in `key[]` have a `compareTo()` method). Thus, declaring `key[]` as `Comparable[]` is required. Delving into the details of programming-language design to explain the reasons would take us somewhat off topic. We use precisely this idiom (and nothing more complicated) in any code that uses `Comparable` generics and arrays throughout this book.

Q&A *(continued)*

Q. What if we need to associate multiple values with the same key? For example, if we use `Date` as a key in an application, wouldn't we have to process equal keys?

A. Maybe, maybe not. For example, you can't have two trains arrive at the station on the same track at the same time (but they could arrive on different tracks at the same time). There are two ways to handle the situation: use some other information to disambiguate or make the value a `Queue` of values having the same key. We consider applications in detail in SECTION 3.5.

Q. Presorting the table as discussed on page 385 seems like a good idea. Why relegate that to an exercise (see EXERCISE 3.1.12)?

A. Indeed, this may be the method of choice in some applications. But adding a slow insert method to a data structure designed for fast search “for convenience” is a performance trap, because an unsuspecting client might intermix searches and inserts in a huge table and experience quadratic performance. Such traps are all too common, so that “buyer beware” is certainly appropriate when using software developed by others, particularly when interfaces are too wide. This problem becomes acute when a large number of methods are included “for convenience” leaving performance traps throughout, while a client might expect efficient implementations of all methods. Java's `ArrayList` class is an example (see EXERCISE 3.5.27).

EXERCISES

3.1.1 Write a client that creates a symbol table mapping letter grades to numerical scores, as in the table below, then reads from standard input a list of letter grades and computes and prints the GPA (the average of the numbers corresponding to the grades).

A+	A	A-	B+	B	B-	C+	C	C-	D	F
4.33	4.00	3.67	3.33	3.00	2.67	2.33	2.00	1.67	1.00	0.00

3.1.2 Develop a symbol-table implementation `ArrayST` that uses an (unordered) array as the underlying data structure to implement our basic symbol-table API.

3.1.3 Develop a symbol-table implementation `OrderedSequentialSearchST` that uses an ordered linked list as the underlying data structure to implement our ordered symbol-table API.

3.1.4 Develop `Time` and `Event` ADTs that allow processing of data as in the example illustrated on page 367.

3.1.5 Implement `size()`, `delete()`, and `keys()` for `SequentialSearchST`.

3.1.6 Give the number of calls to `put()` and `get()` issued by `FrequencyCounter`, as a function of the number W of words and the number D of distinct words in the input.

3.1.7 What is the average number of distinct keys that `FrequencyCounter` will find among N random nonnegative integers less than 1,000, for $N=10, 10^2, 10^3, 10^4, 10^5,$ and 10^6 ?

3.1.8 What is the most frequently used word of ten letters or more in *Tale of Two Cities*?

3.1.9 Add code to `FrequencyCounter` to keep track of the *last* call to `put()`. Print the last word inserted and the number of words that were processed in the input stream prior to this insertion. Run your program for `tale.txt` with length cutoffs 1, 8, and 10.

3.1.10 Give a trace of the process of inserting the keys `E A S Y Q U E S T I O N` into an initially empty table using `SequentialSearchST`. How many compares are involved?

3.1.11 Give a trace of the process of inserting the keys `E A S Y Q U E S T I O N` into an initially empty table using `BinarySearchST`. How many compares are involved?

3.1.12 Modify `BinarySearchST` to maintain one array of `Item` objects that contain keys and values, rather than two parallel arrays. Add a constructor that takes an array of

EXERCISES *(continued)*

Item values as argument and uses mergesort to sort the array.

3.1.13 Which of the symbol-table implementations in this section would you use for an application that does 10^3 `put()` operations and 10^6 `get()` operations, randomly intermixed? Justify your answer.

3.1.14 Which of the symbol-table implementations in this section would you use for an application that does 10^6 `put()` operations and 10^3 `get()` operations, randomly intermixed? Justify your answer.

3.1.15 Assume that searches are 1,000 times more frequent than insertions for a `BinarySearchST` client. Estimate the percentage of the total time that is devoted to insertions, when the number of searches is 10^3 , 10^6 , and 10^9 .

3.1.16 Implement the `delete()` method for `BinarySearchST`.

3.1.17 Implement the `floor()` method for `BinarySearchST`.

3.1.18 Prove that the `rank()` method in `BinarySearchST` is correct.

3.1.19 Modify `FrequencyCounter` to print all of the values having the highest frequency of occurrence, not just one of them. *Hint*: Use a `Queue`.

3.1.20 Complete the proof of PROPOSITION B (show that it holds for all values of N). *Hint*: Start by showing that $C(N)$ is monotonic: $C(N) \leq C(N+1)$ for all $N > 0$.

CREATIVE PROBLEMS

3.1.21 *Memory usage.* Compare the memory usage of `BinarySearchST` with that of `SequentialSearchST` for N key-value pairs, under the assumptions described in SECTION 1.4. Do not count the memory for the keys and values themselves, but do count references to them. For `BinarySearchST`, assume that array resizing is used, so that the array is between 25 percent and 100 percent full.

3.1.22 *Self-organizing search.* A self-organizing search algorithm is one that rearranges items to make those that are accessed frequently likely to be found early in the search. Modify your search implementation for EXERCISE 3.1.2 to perform the following action on every search hit: move the key-value pair found to the beginning of the list, moving all pairs between the beginning of the list and the vacated position to the right one position. This procedure is called the *move-to-front* heuristic.

3.1.23 *Analysis of binary search.* Prove that the maximum number of compares used for a binary search in a table of size N is precisely the number of bits in the binary representation of N , because the operation of shifting 1 bit to the right converts the binary representation of N into the binary representation of $\lfloor N/2 \rfloor$.

3.1.24 *Interpolation search.* Suppose that arithmetic operations are allowed on keys (for example, they may be `Double` or `Integer` values). Write a version of binary search that mimics the process of looking near the beginning of a dictionary when the word begins with a letter near the beginning of the alphabet. Specifically, if k_x is the key value sought, k_{lo} is the key value of the first key in the table, and k_{hi} is the key value of the last key in the table, look first $\lfloor (k_x - k_{lo}) / (k_{hi} - k_{lo}) \rfloor$ -way through the table, not halfway. Test your implementation against `BinarySearchST` for `FrequencyCounter` using `SearchCompare`.

3.1.25 *Software caching.* Since the default implementation of `contains()` calls `get()`, the inner loop of `FrequencyCounter`

```
if (!st.contains(word)) st.put(word, 1);
else st.put(word, st.get(word) + 1);
```

leads to two or three searches for the same key. To enable clear client code like this without sacrificing efficiency, we can use a technique known as *software caching*, where we save the location of the most recently accessed key in an instance variable. Modify `SequentialSearchST` and `BinarySearchST` to take advantage of this idea.

CREATIVE PROBLEMS *(continued)*

3.1.26 *Frequency count from a dictionary.* Modify `FrequencyCounter` to take the name of a dictionary file as its argument, count frequencies of the words from standard input that are also in that file, and print two tables of the words with their frequencies, one sorted by frequency, the other sorted in the order found in the dictionary file.

3.1.27 *Small tables.* Suppose that a `BinarySearchST` client has S search operations and N distinct keys. Give the order of growth of S such that the cost of building the table is the same as the cost of all the searches.

3.1.28 *Ordered insertions.* Modify `BinarySearchST` so that inserting a key that is larger than all keys in the table takes constant time (so that building a table by calling `put()` for keys that are in order takes linear time).

3.1.29 *Test client.* Write a test client `TestBinarySearch.java` for use in testing the implementations of `min()`, `max()`, `floor()`, `ceiling()`, `select()`, `rank()`, `deleteMin()`, `deleteMax()`, and `keys()` that are given in the text. Start with the standard indexing client given on page 370. Add code to take additional command-line arguments, as appropriate.

3.1.30 *Certification.* Add assert statements to `BinarySearchST` to check algorithm invariants and data structure integrity after every insertion and deletion. For example, every index i should always be equal to `rank(select(i))` and the array should always be in order.

EXPERIMENTS

3.1.31 *Performance driver.* Write a performance driver program that uses `put()` to fill a symbol table, then uses `get()` such that each key in the table is hit an average of ten times and there is about the same number of misses, doing so multiple times on random sequences of string keys of various lengths ranging from 2 to 50 characters; measures the time taken for each run; and prints out or plots the average running times.

3.1.32 *Exercise driver.* Write an exercise driver program that uses the methods in our ordered symbol-table API on difficult or pathological cases that might turn up in practical applications. Simple examples include key sequences that are already in order, key sequences in reverse order, key sequences where all keys are the same, and keys consisting of only two distinct values.

3.1.33 *Driver for self-organizing search.* Write a driver program for self-organizing search implementations (see EXERCISE 3.1.22) that uses `get()` to fill a symbol table with N keys, then does $10N$ successful searches according to a predefined probability distribution. Use this driver to compare the running time of your implementation from EXERCISE 3.1.22 with `BinarySearchST` for $N = 10^3, 10^4, 10^5,$ and 10^6 using the probability distribution where search hits the i th smallest key with probability $1/2^i$.

3.1.34 *Zipf's law.* Do the previous exercise for the probability distribution where search hits the i th smallest key with probability $1/(iH_N)$ where H_N is a Harmonic number (see page 185). This distribution is called *Zipf's law*. Compare the move-to-front heuristic with the optimal arrangement for the distributions in the previous exercise, which is to keep the keys in increasing order (decreasing order of their expected frequency).

3.1.35 *Performance validation I.* Run doubling tests that use the first N words of *Tale of Two Cities* for various values of N to test the hypothesis that the running time of `FrequencyCounter` is quadratic when it uses `SequentialSearchST` for its symbol table.

3.1.36 *Performance validation II.* Explain why the performance of `BinarySearchST` and `SequentialSearchST` for `FrequencyCounter` is even better than predicted by analysis.

3.1.37 *Put/get ratio.* Determine empirically the ratio of the amount of time that `BinarySearchST` spends on `put()` operations to the time that it spends on `get()` operations when `FrequencyCounter` is used to find the frequency of occurrence of values

EXPERIMENTS *(continued)*

in 1 million random M -bit `int` values, for $M = 10, 20,$ and 30 . Answer the same question for `ta1e.txt` and compare the results.

3.1.38 *Amortized cost plots.* Develop instrumentation for `FrequencyCounter`, `SequentialSearchST`, and `BinarySearchST` so that you can produce plots like the ones in this section showing the cost of each `put()` operation during the computation.

3.1.39 *Actual timings.* Instrument `FrequencyCounter` to use `Stopwatch` and `StdDraw` to make a plot where the x -axis is the number of calls on `get()` or `put()` and the y -axis is the total running time, with a point plotted of the cumulative time after each call. Run your program for *Tale of Two Cities* using `SequentialSearchST` and again using `BinarySearchST` and discuss the results. *Note:* Sharp jumps in the curve may be explained by *caching*, which is beyond the scope of this question.

3.1.40 *Crossover to binary search.* Find the values of N for which binary search in a symbol table of size N becomes 10, 100, and 1,000 times faster than sequential search. Predict the values with analysis and verify them experimentally.

3.1.41 *Crossover to interpolation search.* Find the values of N for which interpolation search in a symbol table of size N becomes 1, 2, and 10 times faster than binary search, assuming the keys to be random 32-bit integers (see EXERCISE 3.1.24). Predict the values with analysis, and verify them experimentally.

This page intentionally left blank

3.2 BINARY SEARCH TREES

IN THIS SECTION, we will examine a symbol-table implementation that combines the flexibility of insertion in a linked list with the efficiency of search in an ordered array. Specifically, using *two* links per node (instead of the one link per node found in linked lists) leads to an efficient symbol-table implementation based on the binary search tree data structure, which qualifies as one of the most fundamental algorithms in computer science.

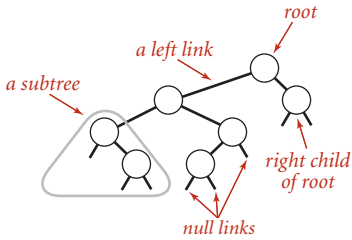

Anatomy of a binary tree

To begin, we define basic terminology. We are working with data structures made up of *nodes* that contain *links* that are either *null* or references to other nodes. In a *binary tree*, we have the restriction that every node is pointed to by just one other node, which is called its *parent* (except for one node, the *root*, which has no nodes pointing to it), and that each node has exactly two links, which are called its *left* and *right* links, that point to nodes called its *left child* and *right child*, respectively. Although links point to nodes, we can

view each link as pointing to a binary tree, the tree whose root is the referenced node. Thus, we can define a binary tree as a either a null link or a node with a left link and a right link, each references to (disjoint) *subtrees* that are themselves binary trees. In a *binary search tree*, each node also has a key and a value, with an ordering restriction to support efficient search.

Definition. A *binary search tree* (BST) is a binary tree where each node has a Comparable key (and an associated value) and satisfies the restriction that the key in any node is larger than the keys in all nodes in that node's left subtree and smaller than the keys in all nodes in that node's right subtree.

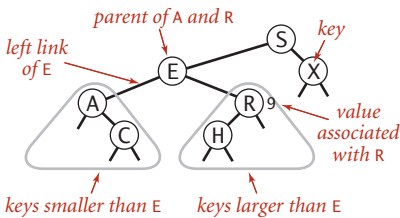

Anatomy of a binary search tree

We draw BSTs with keys in the nodes and use terminology such as “A is the left child of E” that associates nodes with keys. Lines connecting the nodes represent links, and we give the value associated with a key in black, beside the nodes (suppressing the value as dictated by context). Each node's links connect it to nodes below it on the page, except for null links, which are short segments at the bottom. As usual, our examples use the single-letter keys that are generated by our indexing test client.

Basic implementation ALGORITHM 3.3 defines the BST data structure that we use throughout this section to implement the ordered symbol-table API. We begin by considering this classic data structure definition and the characteristic associated implementations of the `get()` (search) and `put()` (insert) methods.

Representation. We define a private nested class to define nodes in BSTs, just as we did for linked lists. Each node contains a key, a value, a left link, a right link, and a node count (when relevant, we include node counts in red above the node in our drawings). The left link points to a BST for items with smaller keys, and the right link points to a BST for items with larger keys. The instance variable `N` gives the node count in the subtree rooted at the node. This field facilitates the implementation of various ordered symbol-table operations, as you will see. The private `size()` method in ALGORITHM 3.3 is implemented to assign the value 0 to null links, so that we can maintain this field by making sure that the invariant

$$\text{size}(x) = \text{size}(x.\text{left}) + \text{size}(x.\text{right}) + 1$$

holds for every node `x` in the tree.

A BST represents a *set* of keys (and associated values), and there are many different BSTs that represent the same set. If we project the keys in a BST such that all keys in each node's left subtree appear to the left of the key in the node and all keys in each node's right subtree appear to the right of the key in the node, then we always get the keys in sorted order. We take advantage of the flexibility inherent in having many BSTs represent this sorted order to develop efficient algorithms for building and using BSTs.

Search. As usual, when we search for a key in a symbol table, we have one of two possible outcomes. If a node containing the key is in the table, we have a *search hit*, so we return the associated value. Otherwise, we have a *search miss* (and return `null`). A recursive algorithm to search for a key in a BST follows immediately from the recursive structure: if the tree is empty, we have a search miss; if the search key is equal to the key at the root, we have a search hit. Otherwise, we search (recursively) in the appropriate subtree, moving left if the search key is smaller, right if it is larger. The recursive `get()` method on page 399 implements this algorithm directly. It takes a node (root of a subtree) as first argument and a key as second argument, starting with the root of the tree and the search key. The code maintains the invariant that no parts of the tree other than the subtree rooted at the current node can have a node whose key is equal to the search key. Just as the size of the interval in binary search shrinks by about half on each iteration,

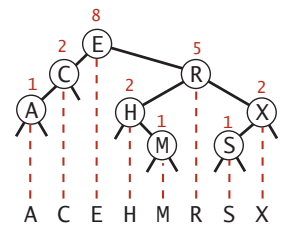
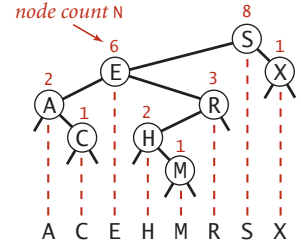

Two BSTs that represent the same set of keys

ALGORITHM 3.3 Binary search tree symbol table

```

public class BST<Key extends Comparable<Key>, Value>
{
    private Node root;           // root of BST

    private class Node
    {
        private Key key;         // key
        private Value val;      // associated value
        private Node left, right; // links to subtrees
        private int N;          // # nodes in subtree rooted here

        public Node(Key key, Value val, int N)
        { this.key = key; this.val = val; this.N = N; }
    }

    public int size()
    { return size(root); }

    private int size(Node x)
    {
        if (x == null) return 0;
        else return x.N;
    }

    public Value get(Key key)
    // See page 399.

    public void put(Key key, Value val)
    // See page 399.

    // See page 407 for min(), max(), floor(), and ceiling().
    // See page 409 for select() and rank().
    // See page 411 for delete(), deleteMin(), and deleteMax().
    // See page 413 for keys().
}

```

This implementation of the ordered symbol-table API uses a binary search tree built from `Node` objects that each contain a key, associated value, two links, and a node count `N`. Each `Node` is the root of a subtree containing `N` nodes, with its left link pointing to a `Node` that is the root of a subtree with smaller keys and its right link pointing to a `Node` that is the root of a subtree with larger keys. The instance variable `root` points to the `Node` at the root of the BST (which has all the keys and associated values in the symbol table). Implementations of other methods appear throughout this section.

ALGORITHM 3.3 (continued) Search and insert for BSTs

```
public Value get(Key key)
{ return get(root, key); }

private Value get(Node x, Key key)
{ // Return value associated with key in the subtree rooted at x;
  // return null if key not present in subtree rooted at x.
  if (x == null) return null;
  int cmp = key.compareTo(x.key);
  if (cmp < 0) return get(x.left, key);
  else if (cmp > 0) return get(x.right, key);
  else return x.val;
}

public void put(Key key, Value val)
{ // Search for key. Update value if found; grow table if new.
  root = put(root, key, val);
}

private Node put(Node x, Key key, Value val)
{
  // Change key's value to val if key in subtree rooted at x.
  // Otherwise, add new node to subtree associating key with val.
  if (x == null) return new Node(key, val, 1);
  int cmp = key.compareTo(x.key);
  if (cmp < 0) x.left = put(x.left, key, val);
  else if (cmp > 0) x.right = put(x.right, key, val);
  else x.val = val;
  x.N = size(x.left) + size(x.right) + 1;
  return x;
}
```

These implementations of `get()` and `put()` for the symbol-table API are characteristic recursive BST methods that also serve as models for several other implementations that we consider later in the chapter. Each method can be understood as both working code and a proof by induction of the inductive hypothesis in the opening comment.

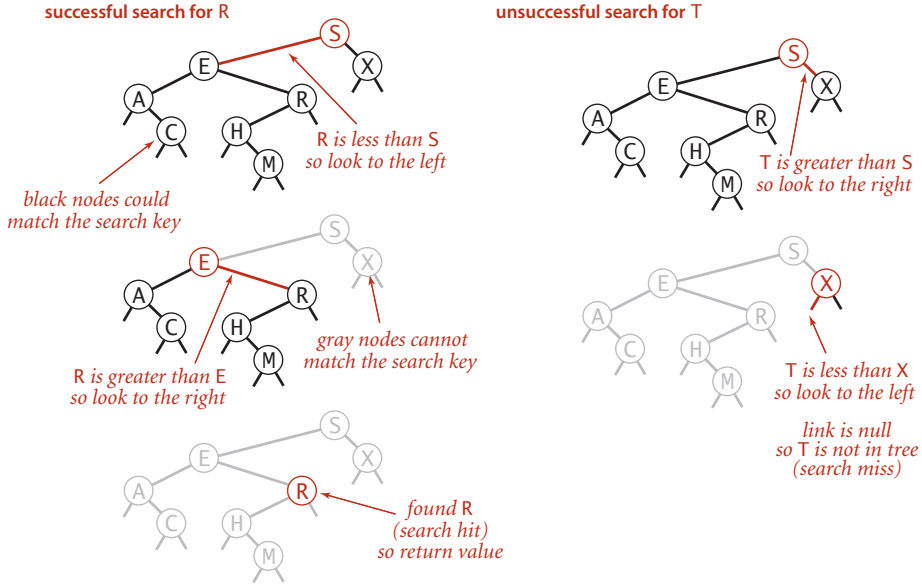

Search hit (left) and search miss (right) in a BST

the size of the subtree rooted at the current node when searching in a BST shrinks when we go down the tree (by about half, ideally, but at least by one). The procedure stops either when a node containing the search key is found (search hit) or when the current subtree becomes empty (search miss). Starting at the top, the search procedure at each node involves a recursive invocation for one of that node's children, so the search defines a path through the tree. For a search hit, the path terminates at the node containing the key. For a search miss, the path terminates at a null link.

Insert. The search code in ALGORITHM 3.3 is almost as simple as binary search; that simplicity is an essential feature of BSTs. A more important essential feature of BSTs is that *insert* is not much more difficult to implement than *search*. Indeed, a search for a key not in the tree ends at a null link, and all that we need to do is replace that link with a new node containing the key (see the diagram on the next page). The recursive `put()` method in ALGORITHM 3.3 accomplishes this task using logic similar to that we used for the recursive search: if the tree is empty, we return a new node containing the key and value; if the search key is less than the key at the root, we set the left link to the result of inserting the key into the left subtree; otherwise, we set the right link to the result of inserting the key into the right subtree.

Recursion. It is worthwhile to take the time to understand the dynamics of these recursive implementations. You can think of the code *before* the recursive calls as happening on the way *down* the tree: it compares the given key against the key at each node and moves right or left accordingly. Then, think of the code *after* the recursive calls as happening on the way *up* the tree. For `get()` this amounts to a series of return statements, but for `put()`, it corresponds to resetting the link of each parent to its child on the search path and to incrementing the counts on the way up the path. In simple BSTs, the only new link is the one at the bottom, but resetting the links higher up on the path is as easy as the test to avoid setting them. Also, we just need to increment the node count on each node on the path, but we use more general code that sets each to one plus the sum of the counts in its subtrees. Later in this section and in the next section, we shall study more advanced algorithms that are naturally expressed with this same recursive scheme but that can change more links on the search paths and need the more general node-count-update code. Elementary BSTs are often implemented with nonrecursive code (see EXERCISE 3.2.12)—we use recursion in our implementations both to make it easy for you to convince yourself that the code is operating as described and to prepare the groundwork for more sophisticated algorithms.

A CAREFUL STUDY of the trace for our standard indexing client that is shown on the next page will give you a feeling for the way in which binary search trees grow. New nodes are attached to null links at the bottom of the tree; the tree structure is not otherwise changed. For example, the root has the first key inserted, one of the children of the root has the second key inserted, and so forth. Because each node has two links, the tree tends to grow out, rather than just down. Moreover, only the keys on the path from the root to the sought or inserted key are examined, so the number of keys examined becomes a smaller and smaller fraction of the number of keys in the tree as the tree size increases.

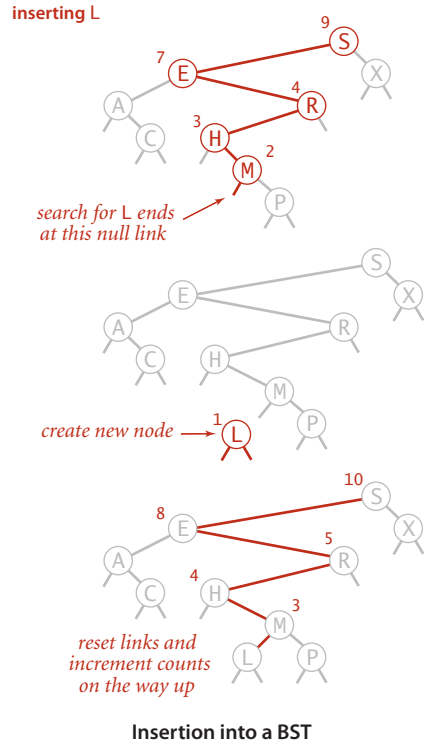

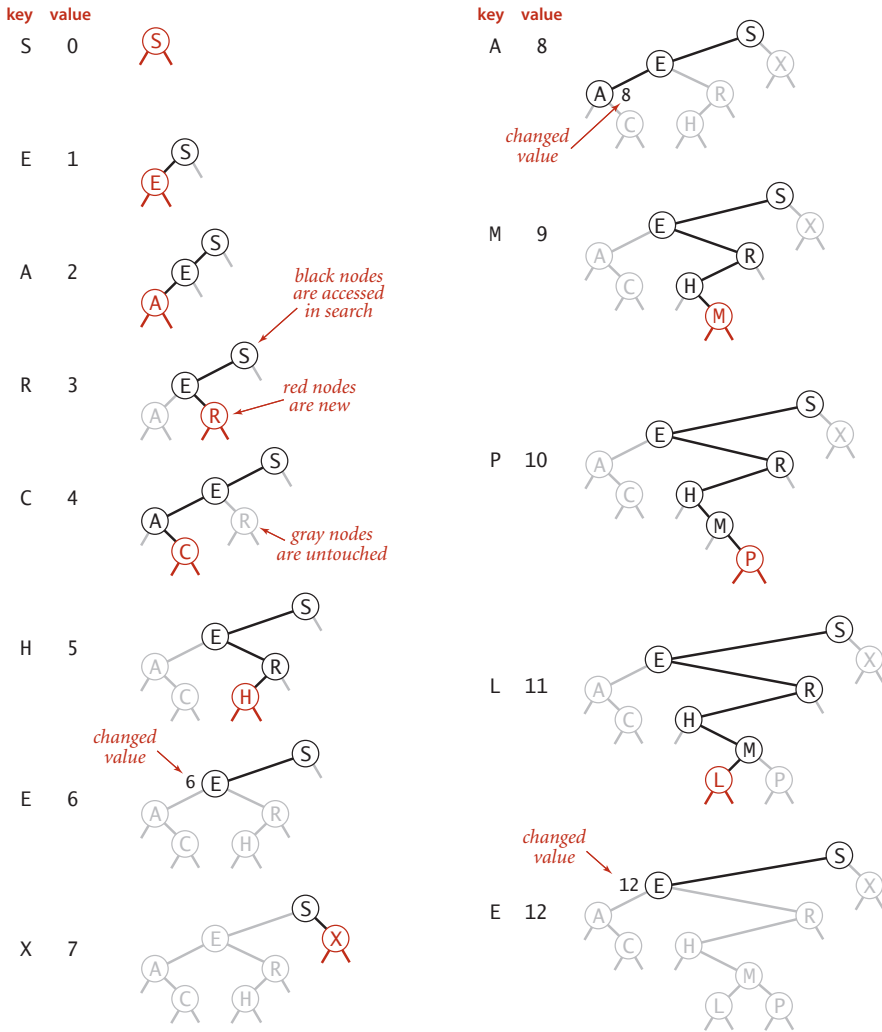

BST trace for standard indexing client

Analysis The running times of algorithms on binary search trees depend on the shapes of the trees, which, in turn, depend on the order in which keys are inserted. In the best case, a tree with N nodes could be perfectly balanced, with $\sim \lg N$ nodes between the root and each null link. In the worst case there could be N nodes on the search path. The balance in typical trees turns out to be much closer to the best case than the worst case.

For many applications, the following simple model is reasonable: We assume that the keys are (uniformly) *random*, or, equivalently, that they are inserted in random order. Analysis of this model stems from the observation that BSTs are dual to quicksort. The node at the root of the tree corresponds to the first partitioning item in quicksort (no keys to the left are larger, and no keys to the right are smaller) and the subtrees are built recursively, corresponding to quicksort's recursive subarray sorts. This observation leads us to the analysis of properties of the trees.

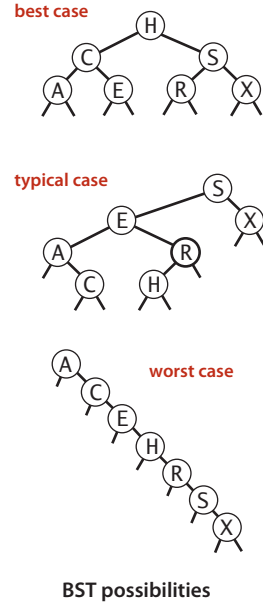

Proposition C. Search hits in a BST built from N random keys require $\sim 2 \ln N$ (about $1.39 \lg N$) compares, on the average.

Proof: The number of compares used for a search hit ending at a given node is 1 plus the depth. Adding the depths of all nodes, we get a quantity known as the *internal path length* of the tree. Thus, the desired quantity is 1 plus the average internal path length of the BST, which we can analyze with the same argument that we used for PROPOSITION K in SECTION 2.3: Let C_N be the total internal path length of a BST built from inserting N randomly ordered distinct keys, so that the average cost of a search hit is $1 + C_N / N$. We have $C_0 = C_1 = 0$ and for $N > 1$ we can write a recurrence relationship that directly mirrors the recursive BST structure:

$$C_N = N - 1 + (C_0 + C_{N-1}) / N + (C_1 + C_{N-2}) / N + \dots + (C_{N-1} + C_0) / N$$

The $N - 1$ term takes into account that the root contributes 1 to the path length of each of the other $N - 1$ nodes in the tree; the rest of the expression accounts for the subtrees, which are equally likely to be any of the N sizes. After rearranging terms, this recurrence is nearly identical to the one that we solved in SECTION 2.3 for quicksort, and we can derive the approximation $C_N \sim 2N \ln N$.

Proposition D. Insertions and search misses in a BST built from N random keys require $\sim 2 \ln N$ (about $1.39 \lg N$) compares, on the average.

Proof: Insertions and search misses take one more compare, on the average, than search hits. This fact is not difficult to establish by induction (see EXERCISE 3.2.16).

PROPOSITION C says that we should expect the BST search cost for random keys to be about 39 percent higher than that for binary search. PROPOSITION D says that the extra cost is well worthwhile, because the cost of inserting a new key is also expected to be logarithmic—flexibility not available with binary search in an ordered array, where the number of array accesses required for an insertion is typically linear. As with quicksort, the standard deviation of the number of compares is known to be low, so that these formulas become increasingly accurate as N increases.

Experiments. How well does our random-key model match what is found in typical symbol-table clients? As usual, this question has to be studied carefully for particular practical applications, because of the large potential variation in performance. Fortunately, for many clients, the model is quite good for BSTs.

For our example study of the cost of the `put()` operations for `FrequencyCounter` for words of length 8 or more, we see a reduction in the average cost from 484 array accesses or compares per operation for `BinarySearchST` to 13 for BST, again providing a quick validation of the logarithmic performance predicted by the theoretical model. More extensive experiments for larger inputs are illustrated in the table on the next page. On the basis of PROPOSITIONS C and D, it is reasonable to predict that this number should be about twice the natural logarithm of the table size, because the preponderance of operations are searches in a nearly full table. This prediction has at least the following inherent inaccuracies:

- Many operations are for smaller tables.
- The keys are not random.
- The table size may be too small for the approximation $2 \ln N$ to be accurate.

Nevertheless, as you can see in the table, this prediction is accurate for our `FrequencyCounter` test cases to within a few compares. Actually, most of the difference can be explained by refining the mathematics in the approximation (see EXERCISE 3.2.35).

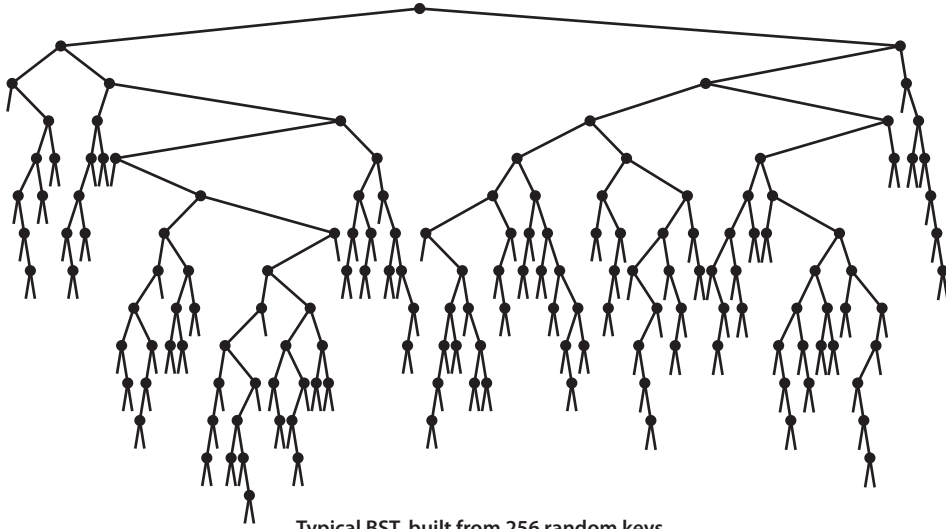

Typical BST, built from 256 random keys

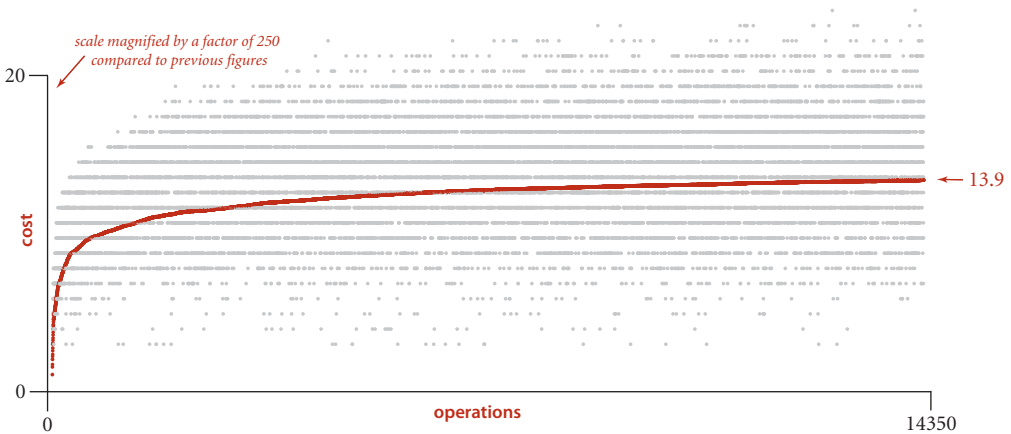

Costs for java FrequencyCounter 8 < tale.txt using BST

	tale.txt				leipzig1M.txt			
	words	distinct	compares		words	distinct	compares	
			model	actual			model	actual
all words	135,635	10,679	18.6	17.5	21,191,455	534,580	23.4	22.1
8+ letters	14,350	5,737	17.6	13.9	4,239,597	299,593	22.7	21.4
10+ letters	4,582	2,260	15.4	13.1	1,610,829	165,555	20.5	19.3

Average number of compares per put() for FrequencyCounter using BST

Order-based methods and deletion An important reason that BSTs are widely used is that they allow us to *keep the keys in order*. As such, they can serve as the basis for implementing the numerous methods in our ordered symbol-table API (see page 366) that allow clients to access key-value pairs not just by providing the key, but also by relative key order. Next, we consider implementations of the various methods in our ordered symbol-table API.

Minimum and maximum. If the left link of the root is null, the smallest key in a BST is the key at the root; if the left link is not null, the smallest key in the BST is the smallest key in the subtree rooted at the node referenced by the left link. This statement is both a description of the recursive `min()` method on page 407 and an inductive proof that it finds the smallest key in the BST. The computation is equivalent to a simple iteration (move left until finding a null link), but we use recursion for consistency. We might have the recursive method return a `Key` instead of a `Node`, but we will later have a need to use this method to access the `Node` containing the minimum key. Finding the maximum key is similar, moving to the right instead of to the left.

Floor and ceiling. If a given key `key` is *less than* the key at the root of a BST, then the floor of `key` (the largest key in the BST less than or equal to `key`) *must* be in the left subtree. If `key` is *greater than* the key at the root, then the floor of `key` *could* be in the right subtree, but only if there is a key smaller than or equal to `key` in the right subtree; if not (or if `key` is equal to the key at the root), then the key at the root is the floor of `key`. Again, this description serves both as the basis for the recursive `floor()` method and for an inductive proof that it computes the desired result. Interchanging right and left (and *less* and *greater*) gives `ceiling()`.

Selection. Selection in a BST works in a manner analogous to the partition-based method of selection in an array that we studied in SECTION 2.5. We maintain in BST nodes the variable `N` that counts the number of keys in the subtree rooted at that node precisely to support this operation.

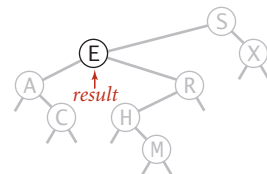
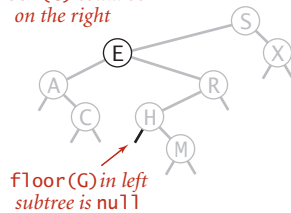
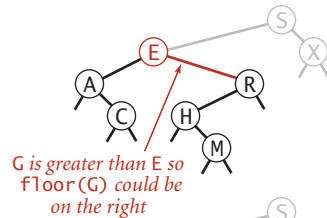
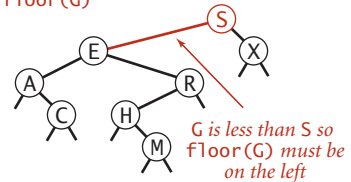
finding `floor(G)`

Computing the floor function

ALGORITHM 3.3 (continued) Min, max, floor, and ceiling in BSTs

```
public Key min()
{
    return min(root).key;
}

private Node min(Node x)
{
    if (x.left == null) return x;
    return min(x.left);
}

public Key floor(Key key)
{
    Node x = floor(root, key);
    if (x == null) return null;
    return x.key;
}

private Node floor(Node x, Key key)
{
    if (x == null) return null;
    int cmp = key.compareTo(x.key);
    if (cmp == 0) return x;
    if (cmp < 0) return floor(x.left, key);
    Node t = floor(x.right, key);
    if (t != null) return t;
    else return x;
}
```

Each client method calls a corresponding private method that takes an additional link (to a `Node`) as argument and returns `null` or a `Node` containing the desired `Key` via the recursive procedure described in the text. The `max()` and `ceiling()` methods are the same as `min()` and `floor()` (respectively) with `right` and `left` (and `<` and `>`) interchanged.

Suppose that we seek the key of rank k (the key such that precisely k other keys in the BST are smaller). If the number of keys t in the left subtree is larger than k , we look (recursively) for the key of rank k in the left subtree; if t is equal to k , we return the key at the root; and if t is smaller than k , we look (recursively) for the key of rank $k - t - 1$ in the right subtree. As usual, this description serves both as the basis for the recursive `select()` method on the facing page and for a proof by induction that it works as expected.

Rank. The inverse method `rank()` that returns the rank of a given key is similar: if the given key is equal to the key at the root, we return the number of keys t in the left subtree; if the given key is less than the key at the root, we return the rank of the key in the left subtree (recursively computed); and if the given key is larger than the key at the root, we return t plus one (to count the key at the root) plus the rank of the key in the right subtree (recursively computed).

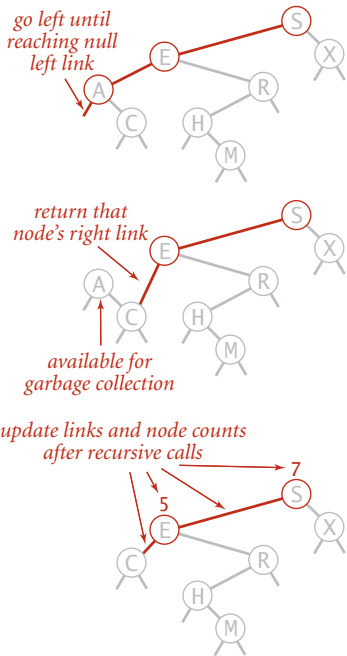

Deleting the minimum in a BST

finding `select(3)`
the key of rank 3

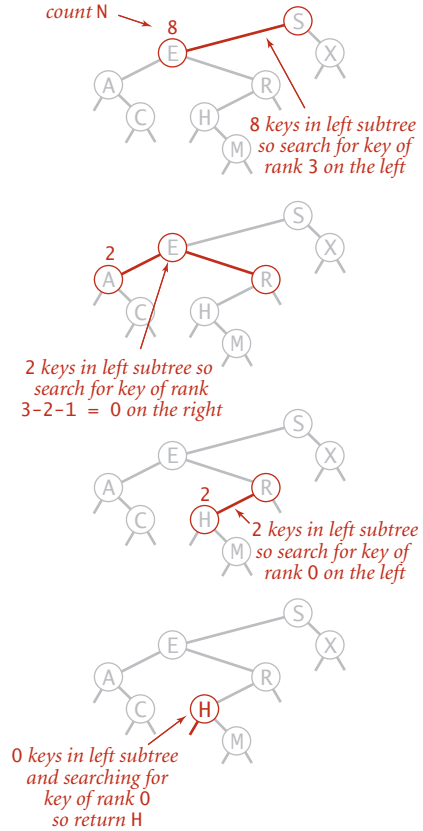

Selection in a BST

Delete the minimum/maximum. The most difficult BST operation to implement is the `delete()` method that removes a key-value pair from the symbol table. As a warmup, consider `deleteMin()` (remove the key-value pair with the smallest key). As with `put()` we write a recursive method that takes a link to a Node as argument and returns a link to a Node, so that we can reflect changes to the tree by assigning the result to the link used as argument. For `deleteMin()` we go left until finding a Node that has a null left link and then replace the link to that node by its right link (simply by returning the right link in the recursive method). The deleted node, with no link now pointing to it, is

ALGORITHM 3.3 (continued) Selection and rank in BSTs

```
public Key select(int k)
{
    return select(root, k).key;
}

private Node select(Node x, int k)
{
    // Return Node containing key of rank k.
    if (x == null) return null;
    int t = size(x.left);
    if (t > k) return select(x.left, k);
    else if (t < k) return select(x.right, k-t-1);
    else return x;
}

public int rank(Key key)
{
    return rank(key, root);
}

private int rank(Key key, Node x)
{
    // Return number of keys less than x.key in the subtree rooted at x.
    if (x == null) return 0;
    int cmp = key.compareTo(x.key);
    if (cmp < 0) return rank(key, x.left);
    else if (cmp > 0) return 1 + size(x.left) + rank(key, x.right);
    else return size(x.left);
}
```

This code uses the same recursive scheme that we have been using throughout this chapter to implement the `select()` and `rank()` methods. It depends on using the private `size()` method given at the beginning of this section that gives the number of subtrees rooted at each node.

available for garbage collection. Our standard recursive setup accomplishes, after the deletion, the task of setting the appropriate link in the parent and updating the counts in all nodes in the path to the root. The symmetric method works for `deleteMax()`.

Delete. We can proceed in a similar manner to delete any node that has one child (or no children), but what can we do to delete a node that has two children? We are left with two links, but have a place in the parent node for only one of them. An answer to this dilemma, first proposed by T. Hibbard in 1962, is to delete a node x by replacing it with its *successor*. Because x has a right child, its successor is the node with the smallest key in its right subtree. The replacement preserves order in the tree because there are no keys between x .key and the successor's key. We can accomplish the task of replacing x by its successor in four (!) easy steps:

- Save a link to the node to be deleted in t .
- Set x to point to its successor $\text{min}(t.\text{right})$.
- Set the right link of x (which is supposed to point to the BST containing all the keys larger than x .key) to $\text{deleteMin}(t.\text{right})$, the link to the BST containing all the keys that are larger than x .key after the deletion.
- Set the left link of x (which was null) to $t.\text{left}$ (all the keys that are less than both the deleted key and its successor).

Our standard recursive setup accomplishes, after the recursive calls, the task of setting the appropriate link in the parent and decrementing the node counts in the nodes on the path to the root (again, we accomplish the task of updating the counts by setting the counts in each node on the search path to be one plus the sum of the counts in its children). While this method does the job, it has a flaw that might cause performance problems in some practical situations. The problem is that the choice of using the successor is arbitrary and not symmetric. Why not use the predecessor? In practice, it is worthwhile to choose at random between the predecessor and the successor. See EXERCISE 3.2.42 for details.

deleting E

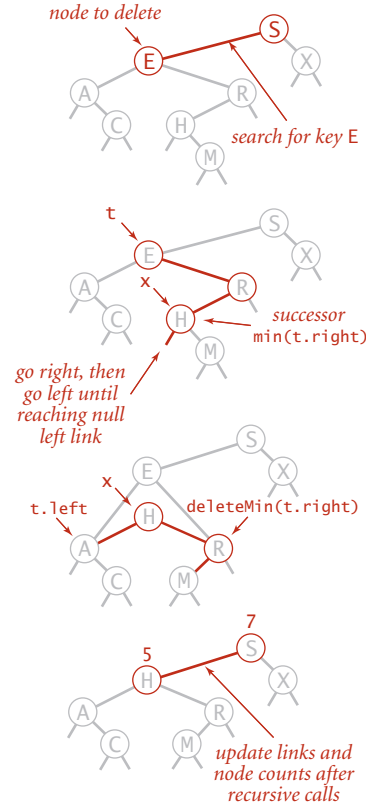

Deletion in a BST

ALGORITHM 3.3 (continued) Deletion in BSTs

```

public void deleteMin()
{
    root = deleteMin(root);
}

private Node deleteMin(Node x)
{
    if (x.left == null) return x.right;
    x.left = deleteMin(x.left);
    x.N = size(x.left) + size(x.right) + 1;
    return x;
}

public void delete(Key key)
{ root = delete(root, key); }

private Node delete(Node x, Key key)
{
    if (x == null) return null;
    int cmp = key.compareTo(x.key);
    if (cmp < 0) x.left = delete(x.left, key);
    else if (cmp > 0) x.right = delete(x.right, key);
    else
    {
        if (x.right == null) return x.left;
        if (x.left == null) return x.right;
        Node t = x;
        x = min(t.right); // See page 407.
        x.right = deleteMin(t.right);
        x.left = t.left;
    }
    x.N = size(x.left) + size(x.right) + 1;
    return x;
}

```

These methods implement eager Hibbard deletion in BSTs, as described in the text on the facing page. The `delete()` code is compact, but tricky. Perhaps the best way to understand it is to read the description at left, try to write the code yourself on the basis of the description, then compare your code with this code. This method is typically effective, but performance in large-scale applications can become a bit problematic (see EXERCISE 3.2.42). The `deleteMax()` method is the same as `deleteMin()` with right and left interchanged.

Range queries. To implement the `keys()` method that returns the keys in a given range, we begin with a basic recursive BST traversal method, known as *inorder traversal*. To illustrate the method, we consider the task of printing all the keys in a BST in order. To do so, print all the keys in the left subtree (which are less than the key at the root by

```
private void print(Node x)
{
    if (x == null) return;
    print(x.left);
    StdOut.println(x.key);
    print(x.right);
}
```

Printing the keys in a BST in order

definition of BSTs), then print the key at the root, then print all the keys in the right subtree (which are greater than the key at the root by definition of BSTs), as in the code at left. As usual, the description serves as an argument by induction that this code prints the keys in order. To implement the two-argument `keys()` method that returns to a client all the keys in a specified range, we modify this code to add each key that is in the range to a `Queue`, and to skip the recursive calls for subtrees that cannot contain keys in the range. As with `BinarySearchST`, the fact that we gather the keys in a `Queue` is hidden from the client. The intention is that clients should process all the keys in the range of interest using Java's `foreach` construct rather than needing to know what data structure we use to implement `Iterable<Key>`.

Analysis. How efficient are the order-based operations in BSTs? To study this question, we consider the *tree height* (the maximum depth of any node in the tree). Given a tree, its height determines the worst-case cost of all BST operations (except for range search which incurs additional cost proportional to the number of keys returned).

Proposition E. In a BST, all operations take time proportional to the height of the tree, in the worst case.

Proof: All of these methods go down one or two paths in the tree. The length of any path is no more than the height, by definition.

We expect the tree height (the worst-case cost) to be higher than the average internal path length that we defined on page 403 (which averages in the short paths as well), but how much higher? This question may seem to you to be similar to the questions answered by `PROPOSITION C` and `PROPOSITION D`, but it is far more difficult to answer, certainly beyond the scope of this book. The average height of a BST built from random keys was shown to be logarithmic by J. Robson in 1979, and L. Devroye later showed that the value approaches $2.99 \lg N$ for large N . Thus, if the insertions in our application are well-described by the random-key model, we are well on the way toward our goal of developing a symbol-table implementation that supports all of these operations

ALGORITHM 3.3 (continued) Range searching in BSTs

```

public Iterable<Key> keys()
{ return keys(min(), max()); }

public Iterable<Key> keys(Key lo, Key hi)
{
    Queue<Key> queue = new Queue<Key>();
    keys(root, queue, lo, hi);
    return queue;
}

private void keys(Node x, Queue<Key> queue, Key lo, Key hi)
{
    if (x == null) return;
    int cmplo = lo.compareTo(x.key);
    int cmphi = hi.compareTo(x.key);
    if (cmplo < 0) keys(x.left, queue, lo, hi);
    if (cmplo <= 0 && cmphi >= 0) queue.enqueue(x.key);
    if (cmphi > 0) keys(x.right, queue, lo, hi);
}

```

To enqueue all the keys from the tree rooted at a given node that fall in a given range onto a queue, we (recursively) enqueue all the keys from the left subtree (if any of them could fall in the range), then enqueue the node at the root (if it falls in the range), then (recursively) enqueue all the keys from the right subtree (if any of them could fall in the range).

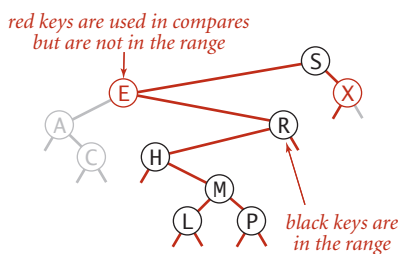
searching in the range [F . . T]**Range search in a BST**

in logarithmic time. We can expect that no path in a tree built from random keys is longer than $3 \lg N$, but what can we expect if the keys are not random? In the next section, you will see why this question is moot in practice because of *balanced BSTs*, which guarantee that the BST height will be logarithmic regardless of the order in which keys are inserted.

IN SUMMARY, BSTs are not difficult to implement and can provide fast search and insert for practical applications of all kinds *if* the key insertions are well-approximated by the random-key model. For our examples (and for many practical applications) BSTs make the difference between being able to accomplish the task at hand and not being able to do so. Moreover, many programmers choose BSTs for symbol-table implementations because they also support fast rank, select, delete, and range query operations. Still, as we have emphasized, the bad worst-case performance of BSTs may not be tolerable in some situations. Good performance of the basic BST implementation is dependent on the keys being sufficiently similar to random keys that the tree is not likely to contain many long paths. With quicksort, we were able to randomize; with a symbol-table API, we do not have that freedom, because the client controls the mix of operations. Indeed, the worst-case behavior is not unlikely in practice—it arises when a client inserts keys in order or in reverse order, a sequence of operations that some client certainly might attempt in the absence of any explicit warnings to avoid doing so. This possibility is a primary reason to seek better algorithms and data structures, which we consider next.

algorithm (data structure)	worst-case cost (after N inserts)		average-case cost (after N random inserts)		efficiently support ordered operations?
	search	insert	search hit	insert	
<i>sequential search</i> (<i>unordered linked list</i>)	N	N	$N/2$	N	no
<i>binary search</i> (<i>ordered array</i>)	$\lg N$	N	$\lg N$	$N/2$	yes
<i>binary tree search</i> (<i>BST</i>)	N	N	$1.39 \lg N$	$1.39 \lg N$	yes

Cost summary for basic symbol-table implementations (updated)

Q&A

Q. I've seen BSTs before, but not using recursion. What are the tradeoffs?

A. Generally, recursive implementations are a bit easier to verify for correctness; non-recursive implementations are a bit more efficient. See EXERCISE 3.2.13 for an implementation of `get()`, the one case where you might notice the improved efficiency. If trees are unbalanced, the depth of the function-call stack could be a problem in a recursive implementation. Our primary reason for using recursion is to ease the transition to the balanced BST implementations of the next section, which definitely are easier to implement and debug with recursion.

Q. Maintaining the node count field in `Node` seems to require a lot of code. Is it really necessary? Why not maintain a single instance variable containing the number of nodes in the tree to implement the `size()` client method?

A. The `rank()` and `select()` methods need to have the size of the subtree rooted at each node. If you are not using these ordered operations, you can streamline the code by eliminating this field (see EXERCISE 3.2.12). Keeping the node count correct for all nodes is admittedly error-prone, but also a good check for debugging. You might also use a recursive method to implement `size()` for clients, but that would take *linear* time to count all the nodes and is a dangerous choice because you might experience poor performance in a client program, not realizing that such a simple operation is so expensive.

EXERCISES

3.2.1 Draw the BST that results when you insert the keys E A S Y Q U E S T I O N, in that order (associating the value i with the i th key, as per the convention in the text) into an initially empty tree. How many compares are needed to build the tree?

3.2.2 Inserting the keys in the order A X C S E R H into an initially empty BST gives a worst-case tree where every node has one null link, except one at the bottom, which has two null links. Give five other orderings of these keys that produce worst-case trees.

3.2.3 Give five orderings of the keys A X C S E R H that, when inserted into an initially empty BST, produce the *best-case* tree.

3.2.4 Suppose that a certain BST has keys that are integers between 1 and 10, and we search for 5. Which sequence below *cannot* be the sequence of keys examined?

- a. 10, 9, 8, 7, 6, 5
- b. 4, 10, 8, 7, 53
- c. 1, 10, 2, 9, 3, 8, 4, 7, 6, 5
- d. 2, 7, 3, 8, 4, 5
- e. 1, 2, 10, 4, 8, 5

3.2.5 Suppose that we have an estimate ahead of time of how often search keys are to be accessed in a BST, and the freedom to insert them in any order that we desire. Should the keys be inserted into the tree in increasing order, decreasing order of likely frequency of access, or some other order? Explain your answer.

3.2.6 Add to BST a method `height()` that computes the height of the tree. Develop two implementations: a recursive method (which takes linear time and space proportional to the height), and a method like `size()` that adds a field to each node in the tree (and takes linear space and constant time per query).

3.2.7 Add to BST a recursive method `avgCompares()` that computes the average number of compares required by a random search hit in a given BST (the internal path length of the tree divided by its size, plus one). Develop two implementations: a recursive method (which takes linear time and space proportional to the height), and a method like `size()` that adds a field to each node in the tree (and takes linear space and constant time per query).

3.2.8 Write a static method `optCompares()` that takes an integer argument N and computes the number of compares required by a random search hit in an optimal (perfectly

balanced) BST, where all the null links are on the same level if the number of links is a power of 2 or on one of two levels otherwise.

3.2.9 Draw all the different BST shapes that can result when N keys are inserted into an initially empty tree, for $N = 2, 3, 4, 5$, and 6 .

3.2.10 Write a test client `TestBST.java` for use in testing the implementations of `min()`, `max()`, `floor()`, `ceiling()`, `select()`, `rank()`, `delete()`, `deleteMin()`, `deleteMax()`, and `keys()` that are given in the text. Start with the standard indexing client given on page 370. Add code to take additional command-line arguments, as appropriate.

3.2.11 How many binary tree shapes of N nodes are there with height N ? How many different ways are there to insert N distinct keys into an initially empty BST that result in a tree of height N ? (See EXERCISE 3.2.2.)

3.2.12 Develop a BST implementation that omits `rank()` and `select()` and does not use a count field in `Node`.

3.2.13 Give nonrecursive implementations of `get()` and `put()` for BST.

Partial solution: Here is an implementation of `get()`:

```
public Value get(Key key)
{
    Node x = root;
    while (x != null)
    {
        int cmp = key.compareTo(x.key);
        if (cmp == 0) return x.val;
        else if (cmp < 0) x = x.left;
        else if (cmp > 0) x = x.right;
    }
    return null;
}
```

The implementation of `put()` is more complicated because of the need to save a pointer to the parent node to link in the new node at the bottom. Also, you need a separate pass to check whether the key is already in the table because of the need to update the counts. Since there are many more searches than inserts in performance-critical implementations, using this code for `get()` is justified; the corresponding change for `put()` might not be noticed.

EXERCISES (continued)

3.2.14 Give nonrecursive implementations of `min()`, `max()`, `floor()`, `ceiling()`, `rank()`, and `select()`.

3.2.15 Give the sequences of nodes examined when the methods in BST are used to compute each of the following quantities for the tree drawn at right.

- a. `floor("Q")`
- b. `select(5)`
- c. `ceiling("Q")`
- d. `rank("J")`
- e. `size("D", "T")`
- f. `keys("D", "T")`

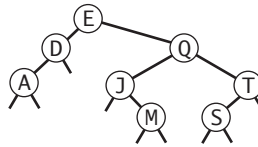

3.2.16 Define the *external path length* of a tree to be the sum of the number of nodes on the paths from the root to all null links. Prove that the difference between the external and internal path lengths in any binary tree with N nodes is $2N$ (see PROPOSITION C).

3.2.17 Draw the sequence of BSTs that results when you delete the keys from the tree of EXERCISE 3.2.1, one by one, in the order they were inserted.

3.2.18 Draw the sequence of BSTs that results when you delete the keys from the tree of EXERCISE 3.2.1, one by one, in alphabetical order.

3.2.19 Draw the sequence of BSTs that results when you delete the keys from the tree of EXERCISE 3.2.1, one by one, by successively deleting the key at the root.

3.2.20 Prove that the running time of the two-argument `keys()` in a BST with N nodes is at most proportional to the tree height plus the number of keys in the range.

3.2.21 Add a BST method `randomKey()` that returns a random key from the symbol table in time proportional to the tree height, in the worst case.

3.2.22 Prove that if a node in a BST has two children, its successor has no left child and its predecessor has no right child.

3.2.23 Is `delete()` commutative? (Does deleting x , then y give the same result as deleting y , then x ?)

3.2.24 Prove that no compare-based algorithm can build a BST using fewer than $\lg(N!) \sim N \lg N$ compares.

CREATIVE PROBLEMS

3.2.25 *Perfect balance.* Write a program that inserts a set of keys into an initially empty BST such that the tree produced is equivalent to binary search, in the sense that the sequence of compares done in the search for any key in the BST is the same as the sequence of compares used by binary search for the same set of keys.

3.2.26 *Exact probabilities.* Find the probability that each of the trees in EXERCISE 3.2.9 is the result of inserting N random distinct elements into an initially empty tree.

3.2.27 *Memory usage.* Compare the memory usage of BST with the memory usage of `BinarySearchST` and `SequentialSearchST` for N key-value pairs, under the assumptions described in SECTION 1.4 (see EXERCISE 3.1.21). Do not count the memory for the keys and values themselves, but do count references to them. Then draw a diagram that depicts the precise memory usage of a BST with `String` keys and `Integer` values (such as the ones built by `FrequencyCounter`), and then estimate the memory usage (in bytes) for the BST built when `FrequencyCounter` uses BST for *Tale of Two Cities*.

3.2.28 *Software caching.* Modify BST to keep the most recently accessed `Node` in an instance variable so that it can be accessed in constant time if the next `put()` or `get()` uses the same key (see EXERCISE 3.1.25).

3.2.29 *Binary tree check.* Write a recursive method `isBinaryTree()` that takes a `Node` as argument and returns `true` if the subtree count field `N` is consistent in the data structure rooted at that node, `false` otherwise. *Note:* This check also ensures that the data structure has no cycles and is therefore a binary tree (!).

3.2.30 *Order check.* Write a recursive method `isOrdered()` that takes a `Node` and two keys `min` and `max` as arguments and returns `true` if all the keys in the tree are between `min` and `max`; `min` and `max` are indeed the smallest and largest keys in the tree, respectively; and the BST ordering property holds for all keys in the tree; `false` otherwise.

3.2.31 *Equal key check.* Write a method `hasNoDuplicates()` that takes a `Node` as argument and returns `true` if there are no equal keys in the binary tree rooted at the argument node, `false` otherwise. Assume that the test of the previous exercise has passed.

3.2.32 *Certification.* Write a method `isBST()` that takes a `Node` as argument and returns `true` if the argument node is the root of a binary search tree, `false` otherwise. *Hint:* This task is also more difficult than it might seem, because the order in which you call the methods in the previous three exercises is important.

CREATIVE PROBLEMS *(continued)*

Solution:

```
private boolean isBST()
{
    if (!isBinaryTree(root)) return false;
    if (!isOrdered(root, min(), max())) return false;
    if (!hasNoDuplicates(root)) return false;
    return true;
}
```

3.2.33 *Select/rank check.* Write a method that checks, for all i from 0 to `size()-1`, whether i is equal to `rank(select(i))` and, for all keys in the BST, whether `key` is equal to `select(rank(key))`.

3.2.34 *Threading.* Your goal is to support an extended API `ThreadedST` that supports the following additional operations in constant time:

<code>Key next(Key key)</code>	<i>key that follows key (null if key is the maximum)</i>
<code>Key prev(Key key)</code>	<i>key that precedes key (null if key is the minimum)</i>

To do so, add fields `pred` and `succ` to `Node` that contain links to the predecessor and successor nodes, and modify `put()`, `deleteMin()`, `deleteMax()`, and `delete()` to maintain these fields.

3.2.35 *Refined analysis.* Refine the mathematical model to better explain the experimental results in the table given in the text. Specifically, show that the average number of compares for a successful search in a tree built from random keys approaches the limit $2 \ln N + 2\gamma - 3 \approx 1.39 \lg N - 1.85$ as N increases, where $\gamma = .57721\dots$ is *Euler's constant*. *Hint:* Referring to the quicksort analysis in SECTION 2.3, use the fact that the integral of $1/x$ approaches $\ln N + \gamma$.

3.2.36 *Iterator.* Is it possible to write a nonrecursive version of `keys()` that uses space proportional to the tree height (independent of the number of keys in the range)?

3.2.37 *Level-order traversal.* Write a method `printLevel()` that takes a `Node` as argument and prints the keys in the subtree rooted at that node in level order (in order of their distance from the root, with nodes on each level in order from left to right). *Hint:* Use a `Queue`.

3.2.38 *Tree drawing.* Add a method `draw()` to `BST` that draws `BST` figures in the style of the text. *Hint:* Use instance variables to hold node coordinates, and use a recursive method to set the values of these variables.

EXPERIMENTS

3.2.39 *Average case.* Run empirical studies to estimate the average and standard deviation of the number of compares used for search hits and for search misses in a BST built by running 100 trials of the experiment of inserting N random keys into an initially empty tree, for $N = 10^4$, 10^5 , and 10^6 . Compare your results against the formula for the average given in EXERCISE 3.2.35.

3.2.40 *Height.* Run empirical studies to estimate average BST height by running 100 trials of the experiment of inserting N random keys into an initially empty tree, for $N = 10^4$, 10^5 , and 10^6 . Compare your results against the $2.99 \lg N$ estimate that is described in the text.

3.2.41 *Array representation.* Develop a BST implementation that represents the BST with three arrays (preallocated to the maximum size given in the constructor): one with the keys, one with array indices corresponding to left links, and one with array indices corresponding to right links. Compare the performance of your program with that of the standard implementation.

3.2.42 *Hibbard deletion degradation.* Write a program that takes an integer N from the command line, builds a random BST of size N , then enters into a loop where it deletes a random key (using the code `delete(select(StdRandom.uniform(N)))`) and then inserts a random key, iterating the loop N^2 times. After the loop, measure and print the average length of a path in the tree (the internal path length divided by N , plus 1). Run your program for $N = 10^2$, 10^3 , and 10^4 to test the somewhat counterintuitive hypothesis that this process increases the average path length of the tree to be proportional to the square root of N . Run the same experiments for a `delete()` implementation that makes a random choice whether to use the predecessor or the successor node.

3.2.43 *Put/get ratio.* Determine empirically the ratio of the amount of time that BST spends on `put()` operations to the time that it spends on `get()` operations when `FrequencyCounter` is used to find the frequency of occurrence of values in 1 million randomly-generated integers.

3.2.44 *Cost plots.* Instrument BST so that you can produce plots like the ones in this section showing the cost of each `put()` operation during the computation (see EXERCISE 3.1.38).

3.2.45 *Actual timings.* Instrument `FrequencyCounter` to use `Stopwatch` and `StdDraw` to make a plot where the x axis is the number of calls on `get()` or `put()` and the y axis

is the total running time, with a point plotted of the cumulative time after each call. Run your program for *Tale of Two Cities* using `SequentialSearchST` and again using `BinarySearchST` and again using `BST` and discuss the results. *Note*: Sharp jumps in the curve may be explained by *caching*, which is beyond the scope of this question (see EXERCISE 3.1.39).

3.2.46 *Crossover to binary search trees.* Find the values of N for which using a binary search tree to build a symbol table of N random `double` keys becomes 10, 100, and 1,000 times faster than binary search. Predict the values with analysis and verify them experimentally.

3.2.47 *Average search time.* Run empirical studies to compute the average and standard deviation of the average length of a path to a random node (internal path length divided by tree size, plus 1) in a BST built by insertion of N random keys into an initially empty tree, for N from 100 to 10,000. Do 1,000 trials for each tree size. Plot the results in a Tufte plot, like the one at the bottom of this page, fit with a curve plotting the function $1.39 \lg N - 1.85$ (see EXERCISE 3.2.35 and EXERCISE 3.2.39).

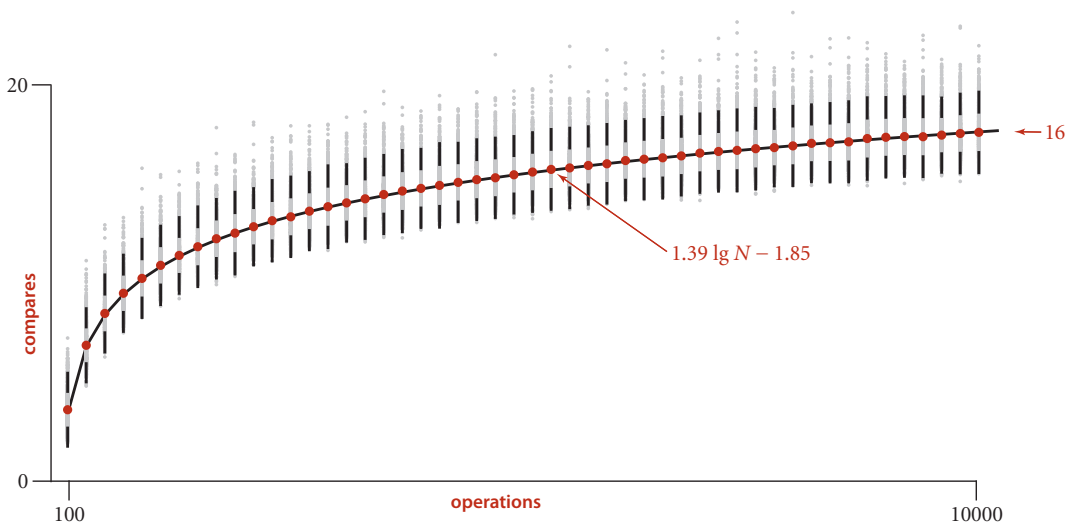

Average path length to a random node in a BST built from random keys

3.3 BALANCED SEARCH TREES

The algorithms in the previous section work well for a wide variety of applications, but they have poor worst-case performance. We introduce in this section a type of binary search tree where costs are *guaranteed* to be logarithmic, no matter what sequence of keys is used to construct them. Ideally, we would like to keep our binary search trees perfectly balanced. In an N -node tree, we would like the height to be $\sim \lg N$ so that we can guarantee that all searches can be completed in $\sim \lg N$ compares, just as for binary search (see PROPOSITION B). Unfortunately, maintaining perfect balance for dynamic insertions is too expensive. In this section, we consider a data structure that slightly relaxes the perfect balance requirement to provide guaranteed logarithmic performance not just for the *insert* and *search* operations in our symbol-table API but also for all of the ordered operations (except range search).

2-3 search trees The primary step to get the flexibility that we need to guarantee balance in search trees is to allow the nodes in our trees to hold more than one key. Specifically, referring to the nodes in a standard BST as *2-nodes* (they hold two links and one key), we now also allow *3-nodes*, which hold three links and two keys. Both 2-nodes and 3-nodes have one link for each of the intervals subtended by its keys.

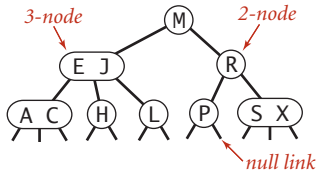

Anatomy of a 2-3 search tree

Definition. A 2-3 search tree is a tree that is either empty or

- A 2-node, with one key (and associated value) and two links, a left link to a 2-3 search tree with smaller keys, and a right link to a 2-3 search tree with larger keys
- A 3-node, with two keys (and associated values) and *three* links, a left link to a 2-3 search tree with smaller keys, a middle link to a 2-3 search tree with keys between the node's keys, and a right link to a 2-3 search tree with larger keys

As usual, we refer to a link to an empty tree as a *null link*.

A *perfectly balanced* 2-3 search tree is one whose null links are all the same distance from the root. To be concise, we use the term *2-3 tree* to refer to a perfectly balanced 2-3 search tree (the term denotes a more general structure in other contexts). Later, we shall see efficient ways to define and implement the basic operations on 2-nodes, 3-nodes, and 2-3 trees; for now, let us assume that we can manipulate them conveniently and see how we can use them as search trees.

successful search for H

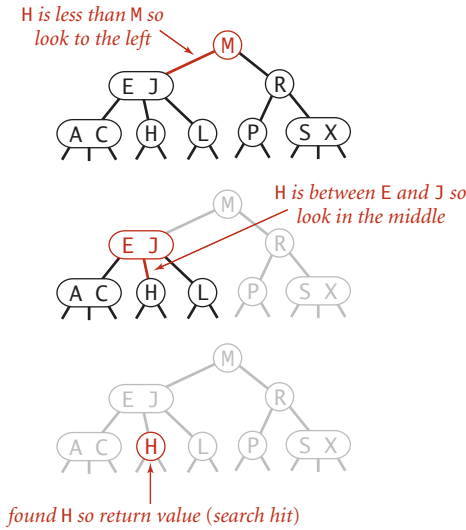

unsuccessful search for B

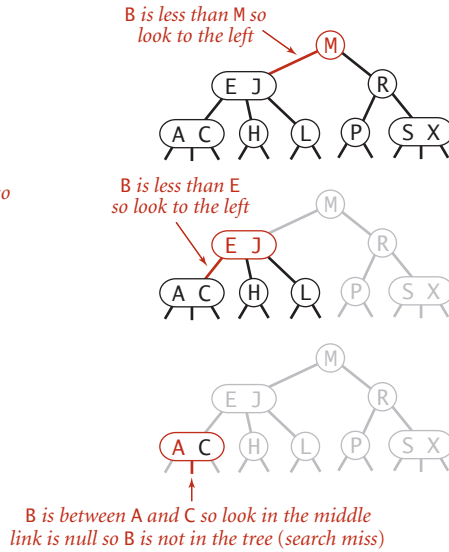

Search hit (left) and search miss (right) in a 2-3 tree

Search. The search algorithm for keys in a 2-3 tree directly generalizes the search algorithm for BSTs. To determine whether a key is in the tree, we compare it against the keys at the root. If it is equal to any of them, we have a search hit; otherwise, we follow the link from the root to the subtree corresponding to the interval of key values that could contain the search key. If that link is null, we have a search miss; otherwise we recursively search in that subtree.

inserting K

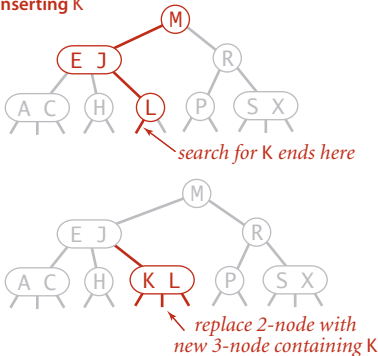

Insert into a 2-node

Insert into a 2-node. To insert a new node in a 2-3 tree, we might do an unsuccessful search and then hook on the node at the bottom, as we did with BSTs, but the new tree would not remain perfectly balanced. The primary reason that 2-3 trees are useful is that we can do insertions and still maintain perfect balance. It is easy to accomplish this task if the node at which the search terminates is a 2-node: we just replace the node with a 3-node containing its key and the new key to be inserted. If the node where the search terminates is a 3-node, we have more work to do.

Insert into a tree consisting of a single 3-node. As a first warmup before considering the general case, suppose that we want to insert into a tiny 2-3 tree consisting of just a single 3-node. Such a tree has two keys, but no room for a new key in its one node. To be able to perform the insertion, we temporarily put the new key into a 4-node, a natural extension of our node type that has three keys and four links. Creating the 4-node is convenient because it is easy to convert it into a 2-3 tree made up of three 2-nodes, one with the middle key (at the root), one with the smallest of the three keys (pointed to by the left link of the root), and one with the largest of the three keys (pointed to by the right link of the root). Such a tree is a 3-node BST and also a perfectly balanced 2-3 search tree, with all the null links at the same distance from the root. Before the insertion, the height of the tree is 0; after the insertion, the height of the tree is 1. This case is simple, but it is worth considering because it illustrates height growth in 2-3 trees.

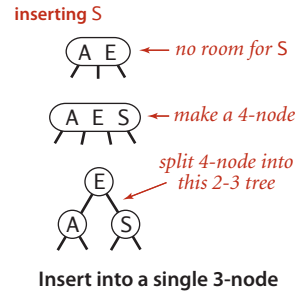

Insert into a 3-node whose parent is a 2-node. As a second warmup, suppose that the search ends at a 3-node at the bottom whose parent is a 2-node. In this case, we can still make room for the new key *while maintaining perfect balance in the tree*, by making a temporary 4-node as just described, then splitting the 4-node as just described, but then, instead of creating a new node to hold the middle key, moving the middle key to the node's parent. You can think of the transformation as replacing the link to the old 3-node in the parent by the middle key with links on either side to the new 2-nodes. By our assumption, there is room for doing so in the parent: the parent was a 2-node (with one key and two links) and becomes a 3-node (with two keys and three links). Also, this transformation does not affect the defining properties of (perfectly balanced) 2-3 trees. The tree remains ordered because the middle key is moved to the parent, and it remains perfectly balanced: if all null links are the same distance from the root before the insertion, they are all the same distance from the root after the insertion. Be certain that you understand this transformation—it is the crux of 2-3 tree dynamics.

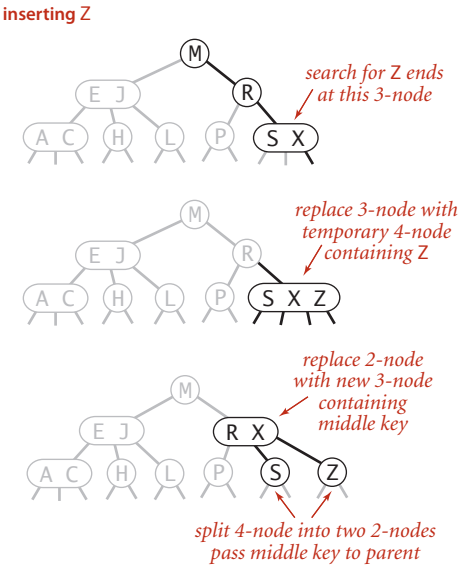

Insert into a 3-node whose parent is a 2-node

Insert into a 3-node whose parent is a 3-node. Now suppose that the search ends at a node whose parent is a 3-node. Again, we make a temporary 4-node as just described, then split it and insert its middle key into the parent. The parent was a 3-node, so we replace it with a temporary new 4-node containing the middle key from the 4-node split. Then, we perform *precisely the same transformation on that node*. That is, we split the new 4-node and insert its middle key into its parent. Extending to the general case is clear: we continue up the tree, splitting 4-nodes and inserting their middle keys in their parents until reaching a 2-node, which we replace with a 3-node that does not need to be further split, or until reaching a 3-node at the root.

Splitting the root. If we have 3-nodes along the whole path from the insertion point to the root, we end up with a temporary 4-node at the root. In this case we can proceed in precisely the same way as for insertion into a tree consisting of a single 3-node. We split the temporary 4-node into three 2-nodes, increasing the height of the tree by 1. Note that this last transformation preserves perfect balance because it is performed at the root.

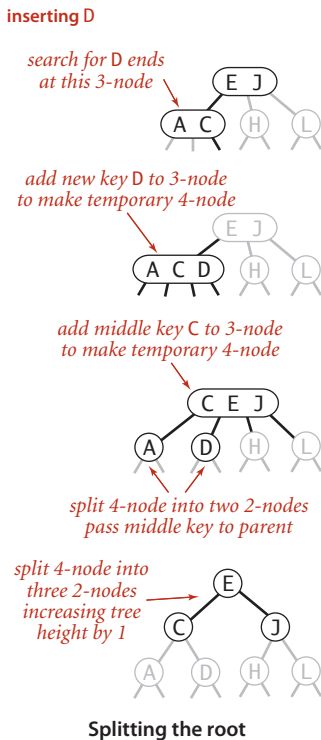

inserting D

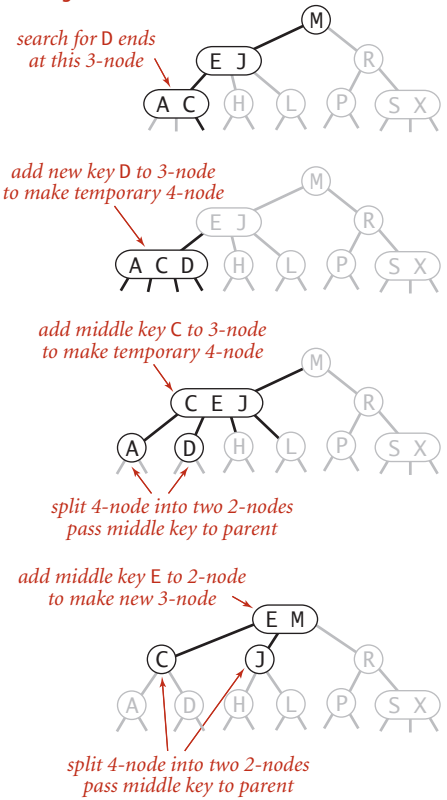

Insert into a 3-node whose parent is a 3-node

We split the temporary 4-node into three 2-nodes, increasing the height of the tree by 1. Note that this last transformation preserves perfect balance because it is performed at the root.

Local transformations. Splitting a temporary 4-node in a 2-3 tree involves one of six transformations, summarized at the bottom of the next page. The 4-node may be the root; it may be the left child or the right child of a 2-node; or it may be the left child, middle child, or right child of a 3-node. The basis of the 2-3 tree insertion algorithm is that all of these transformations are purely *local*: no part of the tree needs to be examined or modified other than the specified nodes and links. The number of

links changed for each transformation is bounded by a small constant. In particular, the transformations are effective when we find the specified patterns *anywhere* in the tree, not just at the bottom. Each of the transformations passes up one of the keys from a 4-node to that node's parent in the tree and then restructures links accordingly, without touching any other part of the tree.

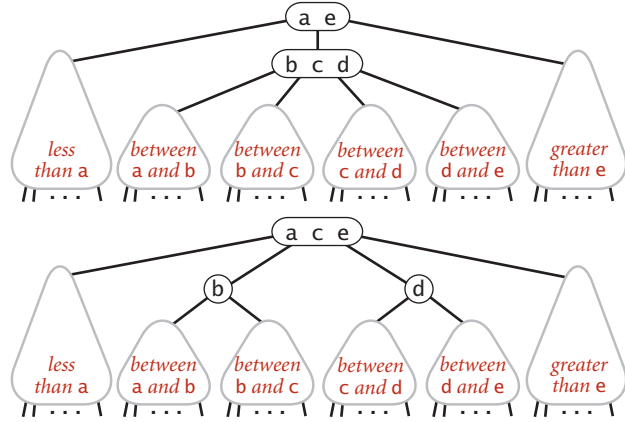

Splitting a 4-node is a local transformation that preserves order and perfect balance

Global properties. Moreover, these *local* transformations preserve the *global* properties that the tree is ordered and perfectly balanced: the number of links on the path from the root to any null link is the same. For reference, a complete diagram illustrating this point for the case that the 4-node is the middle child of a 3-node is shown above. If the length of every path from a root to a null link is h before the transformation, then it is h after the transformation. *Each transformation preserves this property*, even while splitting the 4-node into two 2-nodes and while changing the parent from a 2-node to a 3-node or from a 3-node into a temporary 4-node. When the root splits into three 2-nodes, the length of every path from the root to a null link increases by 1. If you are not fully convinced, work EXERCISE 3.3.7, which asks you to

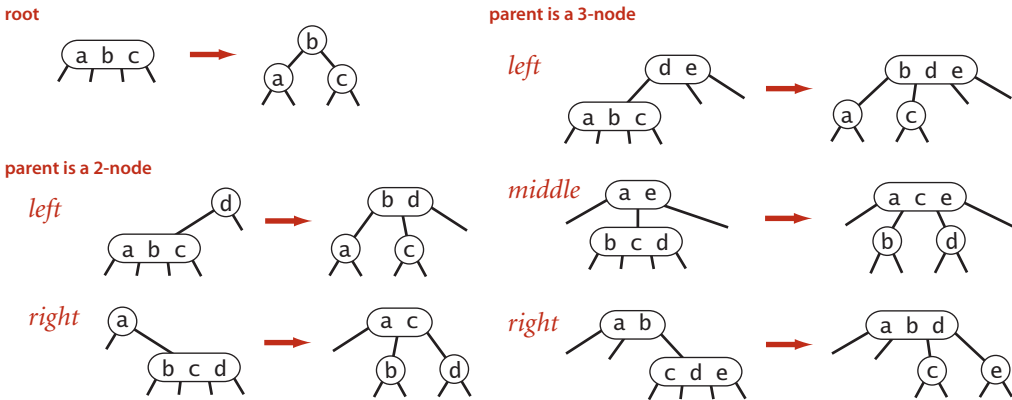

Splitting a temporary 4-node in a 2-3 tree (summary)

extend the diagrams at the top of the previous page for the other five cases to illustrate the same point. Understanding that every local transformation preserves order and perfect balance in the whole tree is the key to understanding the algorithm.

UNLIKE STANDARD BSTS, which grow down from the top, 2-3 trees grow up from the bottom. If you take the time to carefully study the figure on the next page, which gives the sequence of 2-3 trees that is produced by our standard indexing test client and the sequence of 2-3 trees that is produced when the same keys are inserted in increasing order, you will have a good understanding of the way that 2-3 trees are built. Recall that in a BST, the increasing-order sequence for 10 keys results in a worst-case tree of height 9. In the 2-3 trees, the height is 2.

The preceding description is sufficient to define a symbol-table implementation with 2-3 trees as the underlying data structure. Analyzing 2-3 trees is different from analyzing BSTs because our primary interest is in *worst-case* performance, as opposed to average-case performance (where we analyze expected performance under the random-key model). In symbol-table implementations, we normally have no control over the order in which clients insert keys into the table and worst-case analysis is one way to provide performance guarantees.

Proposition F. Search and insert operations in a 2-3 tree with N keys are guaranteed to visit at most $\lg N$ nodes.

Proof: The height of an N -node 2-3 tree is between $\lceil \log_3 N \rceil = \lceil (\lg N)/(\lg 3) \rceil$ (if the tree is all 3-nodes) and $\lceil \lg N \rceil$ (if the tree is all 2-nodes) (see EXERCISE 3.3.4).

Thus, we can guarantee good worst-case performance with 2-3 trees. The amount of time required at each node by each of the operations is bounded by a constant, and both operations examine nodes on just one path, so the total cost of any search or insert is guaranteed to be logarithmic. As you can see from comparing the 2-3 tree depicted at the bottom of page 431 with the BST formed from the same keys on page 405, a perfectly balanced 2-3 tree strikes a remarkably flat posture. For example, the height of a 2-3 tree that contains 1 billion keys is between 19 and 30. It is quite remarkable that we can guarantee to perform arbitrary search and insertion operations among 1 billion keys by examining at most 30 nodes.

However, we are only part of the way to an implementation. Although it is possible to write code that performs transformations on distinct data types representing 2- and 3-nodes, most of the tasks that we have described are inconvenient to implement in

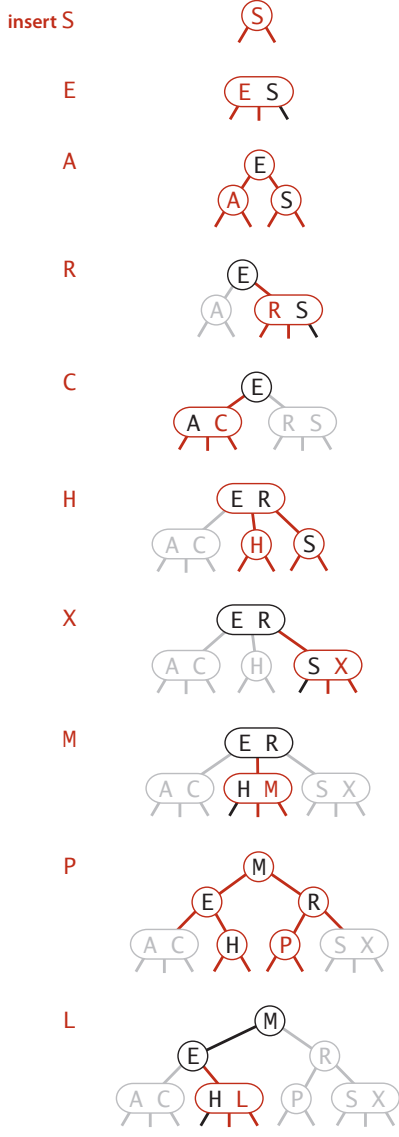

standard indexing client

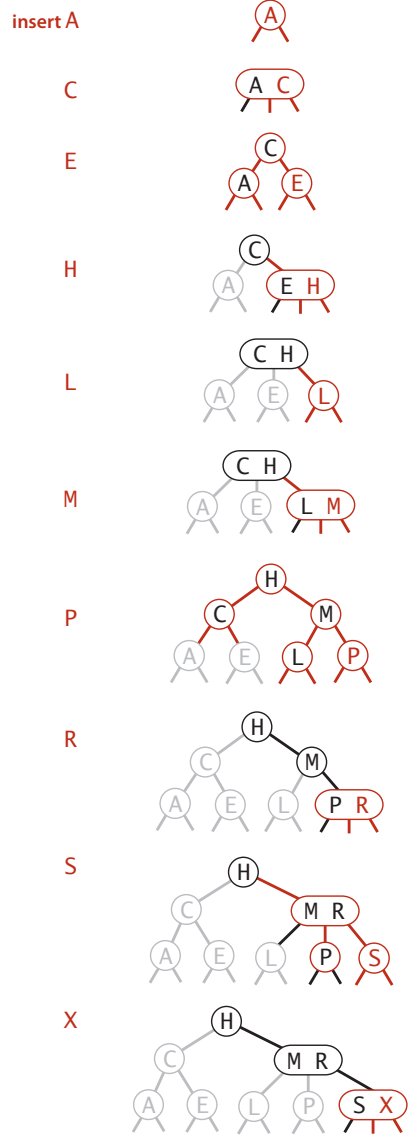

same keys in increasing order

2-3 construction traces

this direct representation because there are numerous different cases to be handled. We would need to maintain two different types of nodes, compare search keys against each of the keys in the nodes, copy links and other information from one type of node to another, convert nodes from one type to another, and so forth. Not only is there a substantial amount of code involved, but the overhead incurred could make the algorithms slower than standard BST search and insert. The primary purpose of balancing is to provide insurance against a bad worst case, but we would prefer the overhead cost for that insurance to be low. Fortunately, as you will see, we can do the transformations in a uniform way using little overhead.

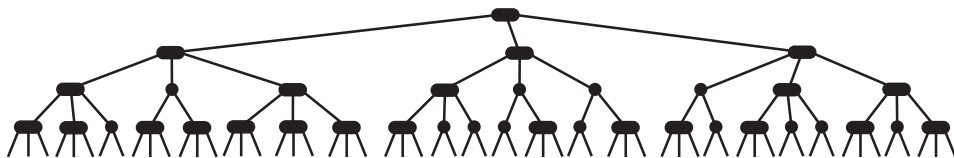

Typical 2-3 tree built from random keys

Red-black BSTs The insertion algorithm for 2-3 trees just described is not difficult to understand; now, we will see that it is also not difficult to implement. We will consider a simple representation known as a *red-black BST* that leads to a natural implementation. In the end, not much code is required, but understanding how and why the code gets the job done requires a careful look.

Encoding 3-nodes. The basic idea behind red-black BSTs is to encode 2-3 trees by starting with standard BSTs (which are made up of 2-nodes) and adding extra information to encode 3-nodes. We think of the links as being of two different types: *red* links, which bind together two 2-nodes to represent 3-nodes, and *black* links, which bind together the 2-3 tree. Specifically, we represent 3-nodes as two 2-nodes connected by a single red link that *leans left* (one of the 2-nodes is the left child of the other). One advantage of using such a representation is that it allows us to use our `get()` code for standard BST search *without modification*. Given any 2-3 tree, we can immediately derive a corresponding BST, just by converting each node as specified. We refer to BSTs that represent 2-3 trees in this way as *red-black BSTs*.

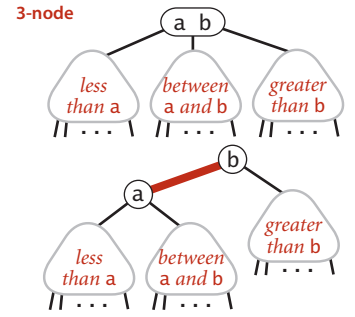

Encoding a 3-node with two 2-nodes connected by a left-leaning red link

An equivalent definition. Another way to proceed is to *define* red-black BSTs as BSTs having red and black links and satisfying the following three restrictions:

- Red links lean left.
- No node has two red links connected to it.
- The tree has *perfect black balance*: every path from the root to a null link has the same number of black links.

There is a 1-1 correspondence between red-black BSTs defined in this way and 2-3 trees.

A 1-1 correspondence. If we draw the red links horizontally in a red-black BST, all of the null links are the same distance from the root, and if we then collapse together the nodes connected by red links, the result is a 2-3 tree. Conversely, if we draw 3-nodes in

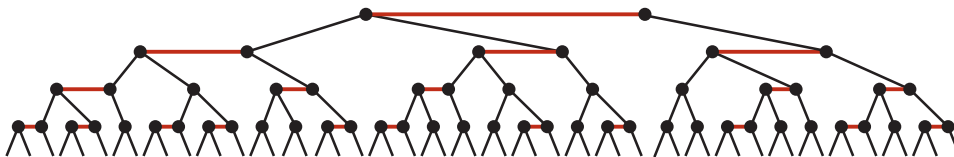

A red-black tree with horizontal red links is a 2-3 tree

red-black BST

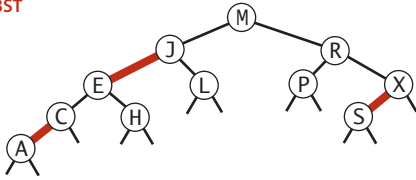

horizontal red links

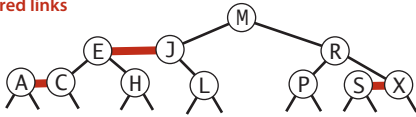

2-3 tree

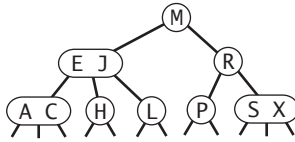

a 2-3 tree as two 2-nodes connected by a red link that leans left, then no node has two red links connected to it, and the tree has perfect black balance, since the black links correspond to the 2-3 tree links, which are perfectly balanced by definition. Whichever way we choose to define them, red-black BSTs are *both* BSTs and 2-3 trees. Thus, if we can implement the 2-3 tree insertion algorithm by maintaining the 1-1 correspondence, then we get the best of both worlds: the simple and efficient search method from standard BSTs and the efficient insertion-balancing method from 2-3 trees.

1-1 correspondence between red-black BSTs and 2-3 trees

Color representation. For convenience, since each node is pointed to by precisely one link (from its parent), we encode the color of links in *nodes*, by adding a boolean instance variable `color` to our `Node` data type, which is `true` if the link from the parent is red and `false` if it is black. By convention, null links are black. For clarity in our code, we define constants `RED` and `BLACK` for use in setting and testing this variable. We use a private method `isRed()` to test the color of a node's link to its parent. When we refer to the color of a node, we are referring to the color of the link pointing to it, and vice versa.

Rotations. The implementation that we will consider might allow right-leaning red links or two red links in a row during an operation, but it always corrects these conditions before completion, through judicious use of an operation called *rotation* that switches the orientation of

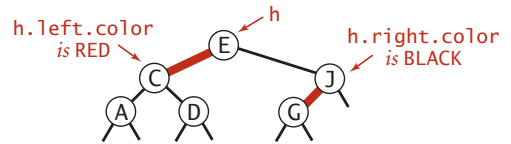

```
private static final boolean RED = true;
private static final boolean BLACK = false;

private class Node
{
    Key key;           // key
    Value val;        // associated data
    Node left, right; // subtrees
    int N;            // # nodes in this subtree
    boolean color;    // color of link from
                    // parent to this node

    Node(Key key, Value val, int N, boolean color)
    {
        this.key = key;
        this.val = val;
        this.N = N;
        this.color = color;
    }
}

private boolean isRed(Node x)
{
    if (x == null) return false;
    return x.color == RED;
}
```

Node representation for red-black BSTs

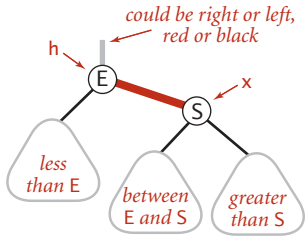

```
Node rotateLeft(Node h)
{
    Node x = h.right;
    h.right = x.left;
    x.left = h;
    x.color = h.color;
    h.color = RED;
    x.N = h.N;
    h.N = 1 + size(h.left)
        + size(h.right);
    return x;
}
```

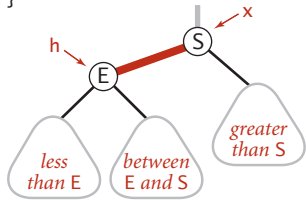

Left rotate (right link of h)

red links. First, suppose that we have a right-leaning red link that needs to be rotated to lean to the left (see the diagram at left). This operation is called a *left rotation*. We organize the computation as a method that takes a link to a red-black BST as argument and, assuming that link to be to a Node *h* whose right link is red, makes the necessary adjustments and returns a link to a node that is the root of a red-black BST for the same set of keys whose *left* link is red. If you check each of the lines of code against the before/after drawings in the diagram, you will find this operation is easy to understand: we are switching from having the smaller of the two keys at the root to having the larger of the two keys at the root. Implementing a *right rotation* that converts a left-leaning red link to a right-leaning one amounts to the same code, with left and right interchanged (see the diagram at right below).

Resetting the link in the parent after a rotation. Whether left or right, every rotation leaves us with a link. We always use the link returned by `rotateRight()` or `rotateLeft()` to reset the appropriate link in the parent (or the root of the tree). That may be a right or a left link, but we can always use it to reset the link in the parent. This link may be red or black—both `rotateLeft()` and

`rotateRight()` preserve its color by setting `x.color` to `h.color`. This might allow two red links in a row to occur within the tree, but our algorithms will also use rotations to correct this condition when it arises. For example, the code

```
h = rotateLeft(h);
```

rotates left a right-leaning red link that is to the right of node *h*, setting *h* to point to the root of the resulting subtree (which contains all the same nodes as the subtree pointed to by *h* before the rotation, but a different root). The ease of writing this type of code is the primary reason we use recursive implementations of BST methods, as it makes doing rotations an easy supplement to normal insertion, as you will see.

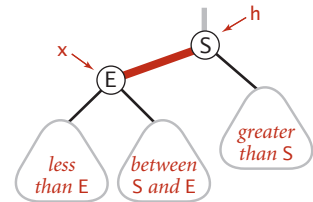

```
Node rotateRight(Node h)
{
    Node x = h.left;
    h.left = x.right;
    x.right = h;
    x.color = h.color;
    h.color = RED;
    x.N = h.N;
    h.N = 1 + size(h.left)
        + size(h.right);
    return x;
}
```

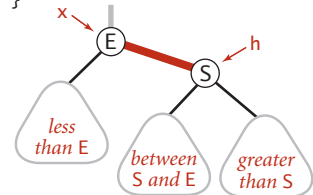

Right rotate (left link of h)

WE CAN USE ROTATIONS to help maintain the 1-1 correspondence between 2-3 trees and red-black BSTs as new keys are inserted because they preserve the two defining properties of red-black BSTs: *order* and *perfect black balance*. That is, we can use rotations on a red-black BST without having to worry about losing its order or its perfect black balance. Next, we see how to use rotations to preserve the other two defining properties of red-black BSTs (no consecutive red links on any path and no right-leaning red links). We warm up with some easy cases.

Insert into a single 2-node. A red-black BST with 1 key is just a single 2-node. Inserting the second key immediately shows the need for having a rotation operation. If the new key is smaller than the key in the tree, we just make a new (red) node with the new key and we are done: we have a red-black BST that is equivalent to a single 3-node. But if the new key is larger than the key in the tree, then attaching a new (red) node gives a right-leaning red link, and the code `root = rotateLeft(root)`; completes the insertion by rotating the red link to the left and updating the tree root link. The result in both cases is the red-black representation of a single 3-node, with two keys, one left-leaning red link, and black height 1.

Insert into a 2-node at the bottom. We insert keys into a red-black BST as usual into a BST, adding a new node at the bottom (respecting the order), but always connected to its parent with a red link. If the parent is a 2-node, then the same two cases just discussed are effective. If the new node is attached to the left link, the parent simply becomes a 3-node; if it is attached to a right link, we have a 3-node leaning the wrong way, but a left rotation finishes the job.

Insert into a tree with two keys (in a 3-node). This case reduces to three subcases: the new key is either less than both keys in the tree, between them, or greater than both of them. Each of the cases introduces a node with two red links connected to it; our goal is to correct this condition.

- The simplest of the three cases is when the new key is *larger* than the two in the tree and is therefore attached on the rightmost link of the 3-node, making a balanced tree with the middle key at the root, connected with red links to nodes containing a smaller and a larger key. If we flip the colors of those two links from red to black, then we have a balanced tree of height 2 with three nodes, exactly what we need to maintain our 1-1 correspondence to 2-3 trees. The other two cases eventually reduce to this case.

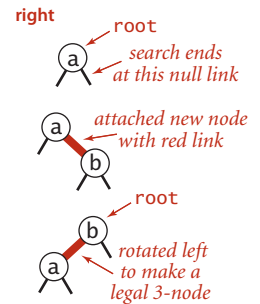
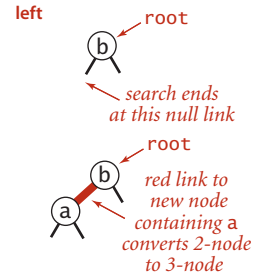

Insert into a single 2-node (two cases)

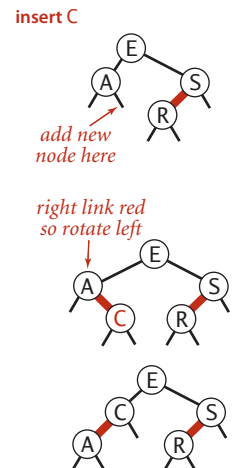

Insert into a 2-node at the bottom

- If the new key is *smaller* than the two keys in the tree and goes on the left link, then we have two red links in a row, both leaning to the left, which we can reduce to the previous case (middle key at the root, connected to the others by two red links) by rotating the top link to the right.
- If the new key goes *between* the two keys in the tree, we

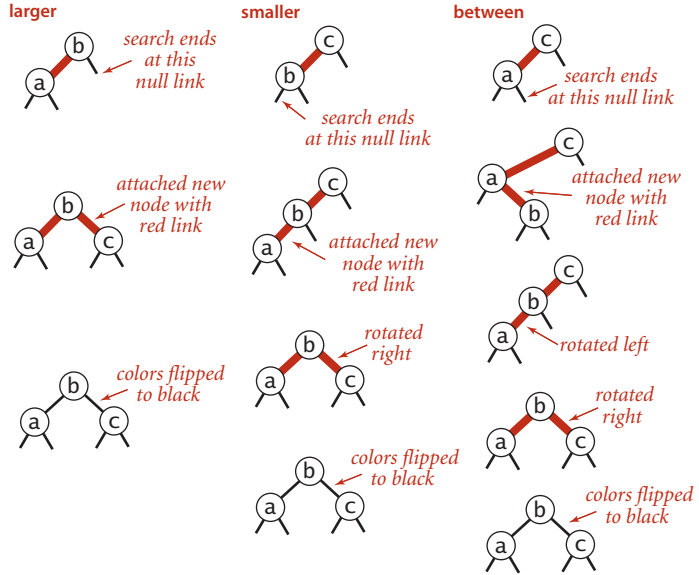

Insert into a single 3-node (three cases)

again have two red links in a row, a right-leaning one below a left-leaning one, which we can reduce to the previous case (two red links in a row, to the left) by rotating left the bottom link.

In summary, we achieve the desired result by doing zero, one, or two rotations followed by flipping the colors of the two children of the root. As with 2-3 trees, *be certain that you understand these transformations*, as they are the key to red-black tree dynamics.

Flipping colors. To flip the colors of the two red children of a node, we use a method `flipColors()`, shown at left. In addition to flipping the colors of the children from red to black, we also flip the color of the parent from black to red. A critically important characteristic of this operation is that, like rotations, it is a local transformation that *preserves perfect black balance* in the tree. Moreover, this convention immediately leads us to a full implementation, as we describe next.

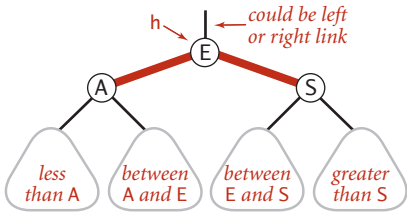

```
void flipColors(Node h)
{
    h.color = RED;
    h.left.color = BLACK;
    h.right.color = BLACK;
}
```

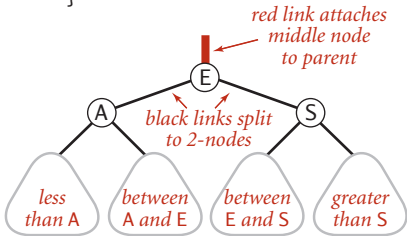

Flipping colors to split a 4-node

Keeping the root black. In the case just considered (insert into a single 3-node), the color flip will color the root red. This can also happen in larger trees. Strictly speaking, a red root implies that the root is part of a 3-node, but that is not the case, so we color the root black after each insertion. Note that the black height of the tree increases by 1 whenever the color of the root is flipped from black to red.

Insert into a 3-node at the bottom. Now suppose that we add a new node at the bottom that is connected to a 3-node. The same three cases just discussed arise. Either the new link is connected to the right link of the 3-node (in which case we just flip colors) or to the left link of the 3-node (in which case we need to rotate the top link right and flip colors) or to the middle link of the 3-node (in which case we rotate left the bottom link, then rotate right the top link, then flip colors). Flipping the colors makes the link to the middle node red, which amounts to passing it up to its parent, putting us back in the same situation with respect to the parent, which we can fix by moving up the tree.

Passing a red link up the tree. The 2-3 tree insertion algorithm calls for us to split the 3-node, passing the middle key up to be inserted into its parent, continuing until encountering a 2-node or the root. In every case we have considered, we precisely accomplish this objective: after doing any necessary rotations, we flip colors, which turns the middle node to red. From the point of view of the parent of that node, that link becoming red can be handled in precisely the same manner as if the red link came from attaching a new node: we pass up a red link to the middle node. The three cases summarized in the diagram on the next page precisely capture the operations necessary in a red-black tree to implement the key operation in 2-3 tree insertion: to insert into a 3-node, create a temporary 4-node, split it, and pass a red link to the middle key up to its parent. Continuing the same process, we pass a red link up the tree until reaching a 2-node or the root.

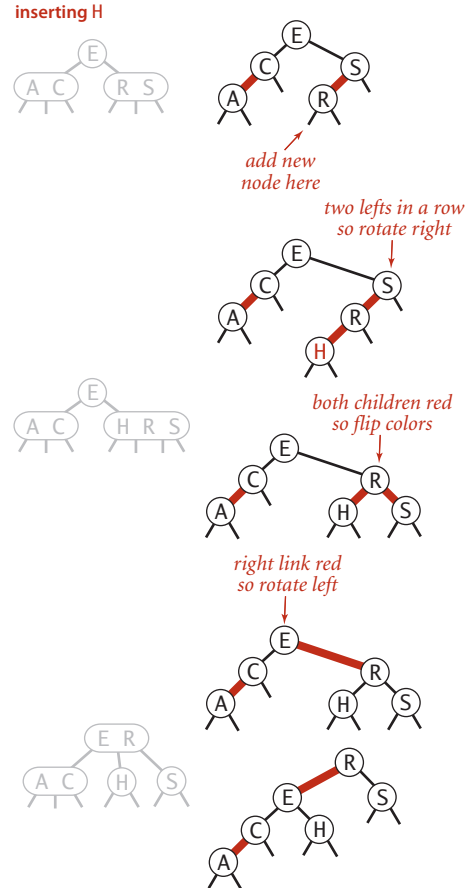

Insert into a 3-node at the bottom

IN SUMMARY, WE CAN MAINTAIN our 1-1 correspondence between 2-3 trees and red-black BSTs during insertion by judicious use of three simple operations: left rotate, right rotate, and color flip. We can accomplish the insertion by performing the following operations, one after the other, on each node as we pass up the tree from the point of insertion:

- If the right child is red and the left child is black, rotate left.
- If both the left child and its left child are red, rotate right.
- If both children are red, flip colors.

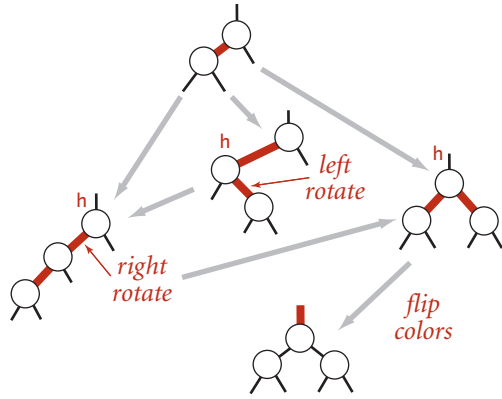

Passing a red link up a red-black BST

It certainly is worth your while to check that this sequence handles each of the cases just described. Note that the first operation handles both the rotation necessary to lean the 3-node to the left when the parent is a 2-node and the rotation necessary to lean the bottom link to the left when the new red link is the middle link in a 3-node.

Implementation Since the balancing operations are to be performed on the way *up* the tree from the point of insertion, implementing them is easy in our standard recursive implementation: we just do them after the recursive calls, as shown in ALGORITHM 3.4. The three operations listed in the previous paragraph each can be accomplished with a single `if` statement that tests the colors of two nodes in the tree. Even though it involves a small amount of code, this implementation would be quite difficult to understand without the two layers of abstraction that we have developed (2-3 trees and red-black BSTs) to implement it. At a cost of testing three to five node colors (and perhaps doing a rotation or two or flipping colors when a test succeeds), we get BSTs that have nearly perfect balance.

The traces for our standard indexing client and for the same keys inserted in increasing order are given on page 440. Considering these examples simply in terms of our three operations on red-black trees, as we have been doing, is an instructive exercise. Another instructive exercise is to check the correspondence with 2-3 trees that the algorithm maintains (using the figure for the same keys given on page 430). In both cases, you can test your understanding of the algorithm by considering the transformations (two color flips and two rotations) that are needed when `P` is inserted into the red-black BST (see EXERCISE 3.3.12).

ALGORITHM 3.4 Insert for red-black BSTs

```

public class RedBlackBST<Key extends Comparable<Key>, Value>
{
    private Node root;

    private class Node // BST node with color bit (see page 433)
    {
        private boolean isRed(Node h) // See page 433.
        private Node rotateLeft(Node h) // See page 434.
        private Node rotateRight(Node h) // See page 434.
        private void flipColors(Node h) // See page 436.

        private int size() // See page 398.

        public void put(Key key, Value val)
        { // Search for key. Update value if found; grow table if new.
            root = put(root, key, val);
            root.color = BLACK;
        }

        private Node put(Node h, Key key, Value val)
        {
            if (h == null) // Do standard insert, with red link to parent.
                return new Node(key, val, 1, RED);

            int cmp = key.compareTo(h.key);
            if (cmp < 0) h.left = put(h.left, key, val);
            else if (cmp > 0) h.right = put(h.right, key, val);
            else h.val = val;

            if (isRed(h.right) && !isRed(h.left)) h = rotateLeft(h);
            if (isRed(h.left) && isRed(h.left.left)) h = rotateRight(h);
            if (isRed(h.left) && isRed(h.right)) flipColors(h);

            h.N = size(h.left) + size(h.right) + 1;
            return h;
        }
    }
}

```

The code for the recursive `put()` for red-black BSTs is identical to `put()` in elementary BSTs except for the three `if` statements after the recursive calls, which provide near-perfect balance in the tree by maintaining a 1-1 correspondence with 2-3 trees, on the way up the search path. The first rotates left any right-leaning 3-node (or a right-leaning red link at the bottom of a temporary 4-node); the second rotates right the top link in a temporary 4-node with two left-leaning red links; and the third flips colors to pass a red link up the tree (see text).

insert S

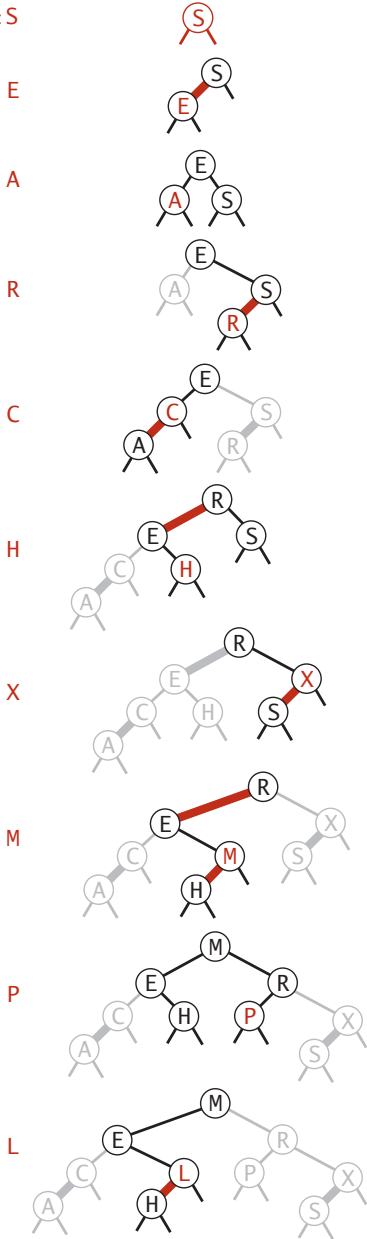

standard indexing client

insert A

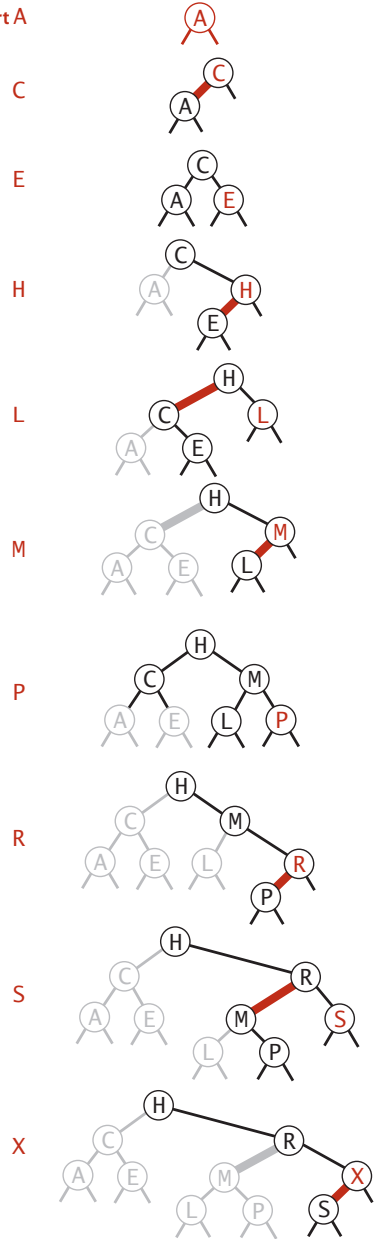

same keys in increasing order

Red-black BST construction traces

Deletion Since `put()` in ALGORITHM 3.4 is already one of the most intricate methods that we consider in this book, and the implementations of `deleteMin()`, `deleteMax()`, and `delete()` for red-black BSTs are a bit more complicated, we defer their full implementations to exercises. Still, the basic approach is worthy of study. To describe it, we begin by returning to 2-3 trees. As with insertion, we can define a sequence of local transformations that allow us to delete a node while still maintaining perfect balance. The process is somewhat more complicated than for insertion, because we do the transformations both on the way *down* the search path, when we introduce temporary 4-nodes (to allow for a node to be deleted), and also on the way *up* the search path, where we split any leftover 4-nodes (in the same manner as for insertion).

Top-down 2-3-4 trees. As a first warmup for deletion, we consider a simpler algorithm that does transformations both on the way down the path and on the way up the path: an insertion algorithm for *2-3-4 trees*, where the temporary 4-nodes that we saw in 2-3 trees can persist in the tree. The insertion algorithm is based on doing transformations on the way down the path to maintain the invariant that the current node is not a 4-node (so we are assured that there will be room to insert the new key at the bottom) and transformations on the way up the path to balance any 4-nodes that may have been created. The transformations on the way down are *precisely* the same transformations that we used for splitting 4-nodes in 2-3 trees. If the root is a 4-node, we split it into three 2-nodes, increasing the height of the tree by 1. On the way down the tree, if we encounter a 4-node with a 2-node as parent, we split the 4-node into two 2-nodes and pass the middle key to the parent, making it a 3-node; if we encounter a 4-node with a 3-node as parent, we split the 4-node into two 2-nodes and pass the middle key to the parent, making it a 4-node. We do not need to worry about encountering a 4-node with a 4-node as parent by virtue of the invariant. At the bottom, we have, again by virtue of the invariant, a 2-node or a 3-node, so we have room to insert the new key. To implement this algorithm with red-black BSTs, we

- Represent 4-nodes as a balanced subtree of three 2-nodes, with both the left and right child connected to the parent with a red link
- Split 4-nodes on the way *down* the tree with color flips
- Balance 4-nodes on the way *up* the tree with rotations, as for insertion

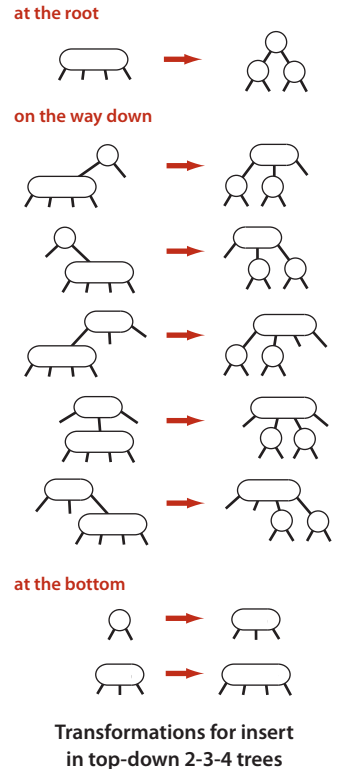

Remarkably, you can implement top-down 2-3-4 trees by moving one line of code in `put()` in ALGORITHM 3.4: move the `colorFlip()` call (and accompanying test) to before the recursive calls (between the test for null and the comparison). This algorithm has some advantages over 2-3 trees in applications where multiple processes have access to the same tree, because it always is operating within a link or two of the current node. The deletion algorithms that we describe next are based on a similar scheme and are effective for these trees as well as for 2-3 trees.

Delete the minimum. As a second warmup for deletion, we consider the operation of deleting the minimum from a 2-3 tree. The basic idea is based on the observation that we can easily delete a key from a 3-node at the bottom of the tree, but not from a 2-node. Deleting the key from a 2-node leaves a node with no keys; the natural thing to do would be to replace the node with a null link, but that operation would violate the perfect balance condition. So, we adopt the following approach: to ensure that we do not end up on a 2-node, we perform appropriate transformations on the way down the tree to preserve the invariant that the current node is not a 2-node (it might be a 3-node or a temporary 4-node). First, at the root, there are two possibilities: if the root is a 2-node and both children are 2-nodes, we can just convert the three nodes to a 4-node; otherwise we can

borrow from the right sibling if necessary to ensure that the left child of the root is not a 2-node. Then, on the way down the tree, one of the following cases must hold:

- If the left child of the current node is not a 2-node, there is nothing to do.
- If the left child is a 2-node and its immediate sibling is not a 2-node, move a key from the sibling to the left child.
- If the left child and its immediate sibling are 2-nodes, then combine them with the smallest key in the parent to make a 4-node, changing the parent from a 3-node to a 2-node or from a 4-node to a 3-node.

Following this process as we traverse left links to the bottom, we wind up on a 3-node or a 4-node with the smallest key, so we can just remove it, converting the 3-node to a

at the root

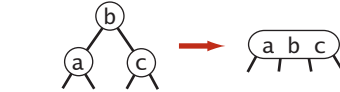

on the way down



at the bottom



Transformations for delete the minimum

2-node or the 4-node to a 3-node. Then, on the way up the tree, we split any unused temporary 4-nodes.

Delete. The same transformations along the search path just described for deleting the minimum are effective to ensure that the current node is not a 2-node during a search for any key. If the search key is at the bottom, we can just remove it. If the key is not at the bottom, then we have to exchange it with its successor as in regular BSTs. Then, since the current node is not a 2-node, we have reduced the problem to deleting the minimum in a subtree whose root is not a 2-node, and we can use the procedure just described for that subtree. After the deletion, as usual, we split any remaining 4-nodes on the search path on the way up the tree.

SEVERAL OF THE EXERCISES at the end of this section are devoted to examples and implementations related to these deletion algorithms. People with an interest in developing or understanding implementations need to master the details covered in these exercises. People with a general interest in the study of algorithms need to recognize that these methods are important because they represent the first symbol-table implementation that we have seen where *search*, *insert*, and *delete* are all guaranteed to be efficient, as we will establish next.

Properties of red-black BSTs Studying the properties of red-black BSTs is a matter of checking the correspondence with 2-3 trees and then applying the analysis of 2-3 trees. The end result is that *all symbol-table operations in red-black BSTs are guaranteed to be logarithmic in the size of the tree* (except for range search, which additionally costs time proportional to the number of keys returned). We repeat and emphasize this point because of its importance.

Analysis. First, we establish that red-black BSTs, while not perfectly balanced, are always nearly so, regardless of the order in which the keys are inserted. This fact immediately follows from the 1-1 correspondence with 2-3 trees and the defining property of 2-3 trees (perfect balance).

Proposition G. The height of a red-black BST with N nodes is no more than $2 \lg N$.

Proof sketch: The worst case is a 2-3 tree that is all 2-nodes except that the leftmost path is made up of 3-nodes. The path taking left links from the root is twice as long as the paths of length $\sim \lg N$ that involve just 2-nodes. It is possible, but not easy, to develop key sequences that cause the construction of red-black BSTs whose average path length is the worst-case $2 \lg N$. If you are mathematically inclined, you might enjoy exploring this issue by working EXERCISE 3.3.24.

This upper bound is conservative: experiments involving both random insertions and insertion sequences found in typical applications support the hypothesis that each search in a red-black BST of N nodes uses about $1.00 \lg N - .5$ compares, on the average. Moreover, you are not likely to encounter a substantially higher average number of compares in practice.

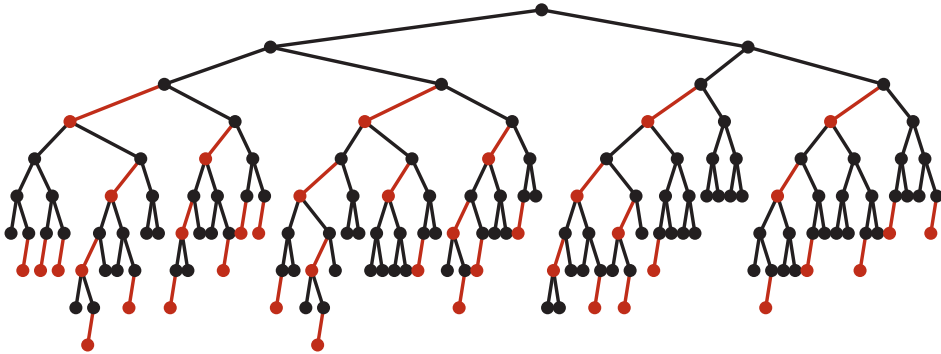

Typical red-black BST built from random keys (null links omitted)

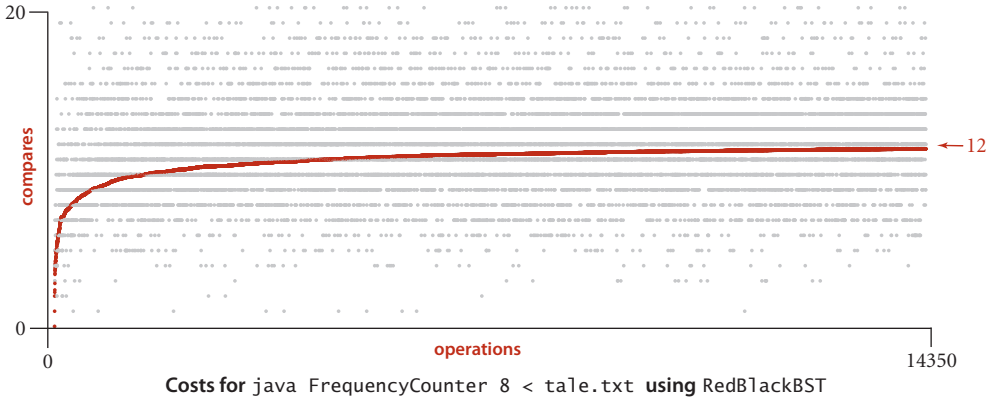

The `get()` method in red-black BSTs does not examine the node color, so the balancing mechanism adds no overhead; search is faster than in elementary BSTs because the tree is balanced. Each key is inserted just once, but may be involved in many, many search operations, so the end result is that we get search times that are close to optimal (because the trees are nearly balanced and no work for balancing is done during the searches) at relatively little cost (unlike binary search, insertions are guaranteed to be logarithmic). The inner loop of the search is a compare followed by updating a link, which is quite short, like the inner loop of binary search (compare and index arithmetic). This implementation is the first we have seen with logarithmic guarantees for both search and insert, and it has a tight inner loop, so its use is justified in a broad variety of applications, including library implementations.

Ordered symbol-table API. One of the most appealing features of red-black BSTs is that the complicated code is limited to the `put()` (and deletion) methods. Our code for the minimum/maximum, select, rank, floor, ceiling and range queries in standard BSTs can be used *without any change*, since it operates on BSTs and has no need to refer to the node color. ALGORITHM 3.4, together with these methods (and the deletion methods), leads to a complete implementation of our ordered symbol-table API. Moreover, all of the methods benefit from the near-perfect balance in the tree because they all require time proportional to the tree height, at most. Thus PROPOSITION 6, in combination with PROPOSITION E, suffices to establish a logarithmic performance guarantee for *all* of them.

Proposition 1. In a red-black BST, the following operations take logarithmic time in the worst case: search, insertion, finding the minimum, finding the maximum, floor, ceiling, rank, select, delete the minimum, delete the maximum, delete, and range count.

Proof: We have just discussed `get()`, `put()`, and the deletion operations. For the others, the code from SECTION 3.2 can be used *verbatim* (it just ignores the node color). Guaranteed logarithmic performance follows from PROPOSITIONS E and G, and the fact that each algorithm performs a constant number of operations on each node examined.

On reflection, it is quite remarkable that we are able to achieve such guarantees. In a world awash with information, where people maintain tables with trillions or quadrillions of entries, the fact is that we can guarantee to complete any one of these operations in such tables with just a few dozen compares.

algorithm (data structure)	worst-case cost (after N inserts)		average-case cost (after N random inserts)		efficiently support ordered operations?
	search	insert	search hit	insert	
<i>sequential search</i> (<i>unordered linked list</i>)	N	N	$N/2$	N	no
<i>binary search</i> (<i>ordered array</i>)	$\lg N$	N	$\lg N$	$N/2$	yes
<i>binary tree search</i> (<i>BST</i>)	N	N	$1.39 \lg N$	$1.39 \lg N$	yes
<i>2-3 tree search</i> (<i>red-black BST</i>)	$2 \lg N$	$2 \lg N$	$1.00 \lg N$	$1.00 \lg N$	yes

Cost summary for symbol-table implementations (updated)

Q&A

Q. Why not let the 3-nodes lean either way and also allow 4-nodes in the trees?

A. Those are fine alternatives, used by many for decades. You can learn about several of these alternatives in the exercises. The left-leaning convention reduces the number of cases and therefore requires substantially less code.

Q. Why not use an array of Key values to represent 2-, 3-, and 4-nodes with a single Node type?

A. Good question. That is precisely what we do for B-trees (see CHAPTER 6), where we allow many more keys per node. For the small nodes in 2-3 trees, the overhead for the array is too high a price to pay.

Q. When we split a 4-node, we sometimes set the color of the right node to RED in `rotateRight()` and then immediately set it to BLACK in `flipColors()`. Isn't that wasteful?

A. Yes, and we also sometimes unnecessarily recolor the middle node. In the grand scheme of things, resetting a few extra bits is not in the same league with the improvement from linear to logarithmic that we get for all operations, but in performance-critical applications, you can put the code for `rotateRight()` and `flipColors()` inline and eliminate those extra tests. We use those methods for deletion, as well, and find them slightly easier to use, understand, and maintain by making sure that they preserve perfect black balance.

EXERCISES

3.3.1 Draw the 2-3 tree that results when you insert the keys E A S Y Q U T I O N in that order into an initially empty tree.

3.3.2 Draw the 2-3 tree that results when you insert the keys Y L P M X H C R A E S in that order into an initially empty tree.

3.3.3 Find an insertion order for the keys S E A R C H X M that leads to a 2-3 tree of height 1.

3.3.4 Prove that the height of a 2-3 tree with N keys is between $\sim \lfloor \log_3 N \rfloor$ and $\sim \lfloor \lg N \rfloor$ (for a tree that is all 3-nodes) and $\sim \lfloor \lg N \rfloor$ (for a tree that is all 2-nodes).

3.3.5 The figure at right shows all the *structurally different* 2-3 trees with N keys, for N from 1 up to 6 (ignore the order of the subtrees). Draw all the structurally different trees for $N = 7, 8, 9$, and 10.

3.3.6 Find the probability that each of the 2-3 trees in EXERCISE 3.3.5 is the result of the insertion of N random distinct keys into an initially empty tree.

3.3.7 Draw diagrams like the one at the top of page 428 for the other five cases in the diagram at the bottom of that page.

3.3.8 Show all possible ways that one might represent a 4-node with three 2-nodes bound together with red links (not necessarily left-leaning).

3.3.9 Which of the following are red-black BSTs?

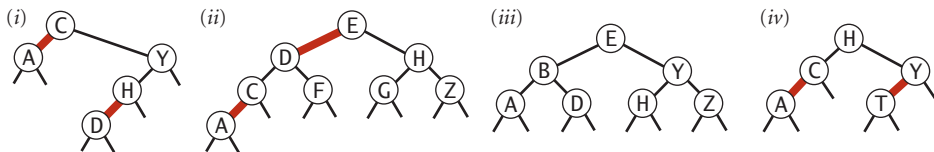

3.3.10 Draw the red-black BST that results when you insert items with the keys E A S Y Q U T I O N in that order into an initially empty tree.

3.3.11 Draw the red-black BST that results when you insert items with the keys Y L P M X H C R A E S in that order into an initially empty tree.

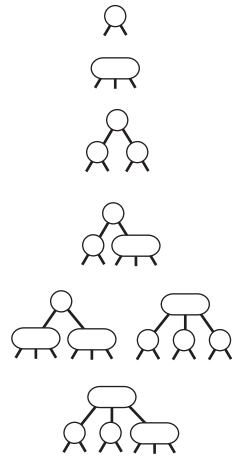

EXERCISES (continued)

3.3.12 Draw the red-black BST that results after each transformation (color flip or rotation) during the insertion of P for our standard indexing client.

3.3.13 True or false: If you insert keys in increasing order into a red-black BST, the tree height is monotonically increasing.

3.3.14 Draw the red-black BST that results when you insert letters A through K in order into an initially empty tree, then describe what happens in general when trees are built by insertion of keys in ascending order (see also the figure in the text).

3.3.15 Answer the previous two questions for the case when the keys are inserted in *descending* order.

3.3.16 Show the result of inserting *n* into the red-black BST drawn at right (only the search path is shown, and you need to include only these nodes in your answer).

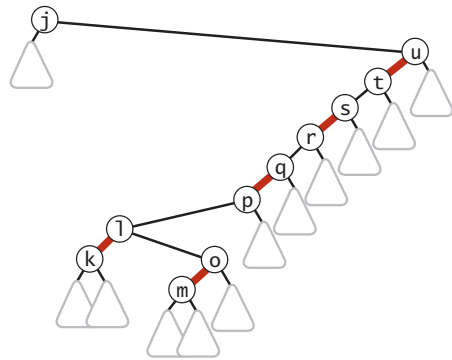

3.3.17 Generate two random 16-node red-black BSTs. Draw them (either by hand or with a program). Compare them with the (unbalanced) BSTs built with the same keys.

3.3.18 Draw all the structurally different red-black BSTs with N keys, for N from 2 up to 10 (see EXERCISE 3.3.5).

3.3.19 With 1 bit per node for color, we can represent 2-, 3-, and 4-nodes. How many bits per node would we need to represent 5-, 6-, 7-, and 8-nodes with a binary tree?

3.3.20 Compute the internal path length in a perfectly balanced BST of N nodes, when N is a power of 2 minus 1.

3.3.21 Create a test client `TestRB.java`, based on your solution to EXERCISE 3.2.10.

3.3.22 Find a sequence of keys to insert into a BST and into a red-black BST such that the height of the BST is less than the height of the red-black BST, or prove that no such sequence is possible.

CREATIVE PROBLEMS

3.3.23 *2-3 trees without balance restriction.* Develop an implementation of the basic symbol-table API that uses 2-3 trees that are not necessarily balanced as the underlying data structure. Allow 3-nodes to lean either way. Hook the new node onto the bottom with a *black* link when inserting into a 3-node at the bottom. Run experiments to develop a hypothesis estimating the average path length in a tree built from N random insertions.

3.3.24 *Worst case for red-black BSTs.* Show how to construct a red-black BST demonstrating that, in the worst case, almost all the paths from the root to a null link in a red-black BST of N nodes are of length $2 \lg N$.

3.3.25 *Top-down 2-3-4 trees.* Develop an implementation of the basic symbol-table API that uses balanced 2-3-4 trees as the underlying data structure, using the red-black representation and the insertion method described in the text, where 4-nodes are split by flipping colors on the way down the search path and balancing on the way up.

3.3.26 *Single top-down pass.* Develop a modified version of your solution to EXERCISE 3.3.25 that does *not* use recursion. Complete all the work splitting and balancing 4-nodes (and balancing 3-nodes) on the way down the tree, finishing with an insertion at the bottom.

3.3.27 *Allow right-leaning red links.* Develop a modified version of your solution to EXERCISE 3.3.25 that allows right-leaning red links in the tree.

3.3.28 *Bottom-up 2-3-4 trees.* Develop an implementation of the basic symbol-table API that uses balanced 2-3-4 trees as the underlying data structure, using the red-black representation and a *bottom-up* insertion method based on the same recursive approach as ALGORITHM 3.4. Your insertion method should split only the sequence of 4-nodes (if any) on the bottom of the search path.

3.3.29 *Optimal storage.* Modify `RedBlackBST` so that it does not use any extra storage for the color bit, based on the following trick: To color a node red, swap its two links. Then, to test whether a node is red, test whether its left child is larger than its right child. You have to modify the compares to accommodate the possible link swap, and this trick replaces bit compares with key compares that are presumably more expensive, but it shows that the bit in the nodes can be eliminated, if necessary.

3.3.30 *Software caching.* Modify `RedBlackBST` to keep the most recently accessed Node in an instance variable so that it can be accessed in constant time if the next `put()` or

CREATIVE PROBLEMS *(continued)*

`get()` uses the same key (see EXERCISE 3.1.25).

3.3.31 *Tree drawing.* Add a method `draw()` to `RedBlackBST` that draws red-black BST figures in the style of the text (see EXERCISE 3.2.38)

3.3.32 *AVL trees.* An *AVL tree* is a BST where the height of every node and that of its sibling differ by at most 1. (The oldest balanced tree algorithms are based on using rotations to maintain height balance in AVL trees.) Show that coloring red links that go from nodes of even height to nodes of odd height in an AVL tree gives a (perfectly balanced) 2-3-4 tree, where red links are not necessarily left-leaning. *Extra credit:* Develop an implementation of the symbol-table API that uses this as the underlying data structure. One approach is to keep a height field in each node, using rotations after the recursive calls to adjust the height as necessary; another is to use the red-black representation and use methods like `moveRedLeft()` and `moveRedRight()` in EXERCISE 3.3.39 and EXERCISE 3.3.40.

3.3.33 *Certification.* Add to `RedBlackBST` a method `is23()` to check that no node is connected to two red links and that there are no right-leaning red links and a method `isBalanced()` to check that all paths from the root to a null link have the same number of black links. Combine these methods with code from `isBST()` in EXERCISE 3.2.32 to create a method `isRedBlackBST()` that checks that the tree is a red-black BST.

3.3.34 *All 2-3 trees.* Write code to generate all structurally different 2-3 trees of height 2, 3, and 4. There are 2, 7, and 122 such trees, respectively. (*Hint:* Use a symbol table.)

3.3.35 *2-3 trees.* Write a program `TwoThreeST.java` that uses two node types to implement 2-3 search trees directly.

3.3.36 *2-3-4-5-6-7-8 trees.* Describe algorithms for search and insertion in balanced 2-3-4-5-6-7-8 search trees.

3.3.37 *Memoryless.* Show that red-black BSTs are *not memoryless*: for example, if you insert a key that is smaller than all the keys in the tree and then immediately delete the minimum, you may get a different tree.

3.3.38 *Fundamental theorem of rotations.* Show that any BST can be transformed into any other BST on the same set of keys by a sequence of left and right rotations.

3.3.39 *Delete the minimum.* Implement the `deleteMin()` operation for red-black BSTs by maintaining the correspondence with the transformations given in the text for moving down the left spine of the tree while maintaining the invariant that the current node is not a 2-node.

Solution:

```
private Node moveRedLeft(Node h)
{ // Assuming that h is red and both h.left and h.left.left
  // are black, make h.left or one of its children red.
  flipColors(h);
  if (isRed(h.right.left))
  {
    h.right = rotateRight(h.right);
    h = rotateLeft(h);
  }
  return h;
}

public void deleteMin()
{
  if (!isRed(root.left) && !isRed(root.right))
    root.color = RED;
  root = deleteMin(root);
  if (!isEmpty()) root.color = BLACK;
}

private Node deleteMin(Node h)
{
  if (h.left == null)
    return null;
  if (!isRed(h.left) && !isRed(h.left.left))
    h = moveRedLeft(h);
  h.left = deleteMin(h.left);
  return balance(h);
}
```

This code assumes a `balance()` method that consists of the line of code

```
if (isRed(h.right)) h = rotateLeft(h);
```

CREATIVE PROBLEMS *(continued)*

followed by the last five lines of the recursive `put()` in ALGORITHM 3.4 and a `flipColors()` implementation that complements the three colors, instead of the method given in the text for insertion. For deletion, we set the parent to BLACK and the two children to RED.

3.3.40 *Delete the maximum.* Implement the `deleteMax()` operation for red-black BSTs. Note that the transformations involved differ slightly from those in the previous exercise because red links are left-leaning.

Solution:

```
private Node moveRedRight(Node h)
{ // Assuming that h is red and both h.right and h.right.left
  // are black, make h.right or one of its children red.
  flipColors(h)
  if (!isRed(h.left.left))
    h = rotateRight(h);
  return h;
}

public void deleteMax()
{
  if (!isRed(root.left) && !isRed(root.right))
    root.color = RED;
  root = deleteMax(root);
  if (!isEmpty()) root.color = BLACK;
}

private Node deleteMax(Node h)
{
  if (isRed(h.left))
    h = rotateRight(h);
  if (h.right == null)
    return null;
  if (!isRed(h.right) && !isRed(h.right.left))
    h = moveRedRight(h);
  h.right = deleteMax(h.right);
  return balance(h);
}
```

3.3.41 Delete. Implement the `delete()` operation for red-black BSTs, combining the methods of the previous two exercises with the `delete()` operation for BSTs.

Solution:

```
public void delete(Key key)
{
    if (!isRed(root.left) && !isRed(root.right))
        root.color = RED;
    root = delete(root, key);
    if (!isEmpty()) root.color = BLACK;
}

private Node delete(Node h, Key key)
{
    if (key.compareTo(h.key) < 0)
    {
        if (!isRed(h.left) && !isRed(h.left.left))
            h = moveRedLeft(h);
        h.left = delete(h.left, key);
    }
    else
    {
        if (isRed(h.left))
            h = rotateRight(h);
        if (key.compareTo(h.key) == 0 && (h.right == null))
            return null;
        if (!isRed(h.right) && !isRed(h.right.left))
            h = moveRedRight(h);
        if (key.compareTo(h.key) == 0)
        {
            h.val = get(h.right, min(h.right).key);
            h.key = min(h.right).key;
            h.right = deleteMin(h.right);
        }
        else h.right = delete(h.right, key);
    }
    return balance(h);
}
```

EXPERIMENTS

3.3.42 *Count red nodes.* Write a program that computes the percentage of red nodes in a given red-black BST. Test your program by running at least 100 trials of the experiment of inserting N random keys into an initially empty tree, for $N = 10^4, 10^5$, and 10^6 , and formulate an hypothesis.

3.3.43 *Cost plots.* Instrument `RedBlackBST` so that you can produce plots like the ones in this section showing the cost of each `put()` operation during the computation (see EXERCISE 3.1.38).

3.3.44 *Average search time.* Run empirical studies to compute the average and standard deviation of the average length of a path to a random node (internal path length divided by tree size) in a red-black BST built by insertion of N random keys into an initially empty tree, for N from 1 to 10,000. Do at least 1,000 trials for each tree size. Plot the results in a Tufte plot, like the one at the bottom of this page, fit with a curve plotting the function $\lg N - .5$.

3.3.45 *Count rotations.* Instrument your program for EXERCISE 3.3.43 to plot the number of rotations and node splits that are used to build the trees. Discuss the results.

3.3.46 *Height.* Instrument your program for EXERCISE 3.3.43 to plot the height of red-black BSTs. Discuss the results.

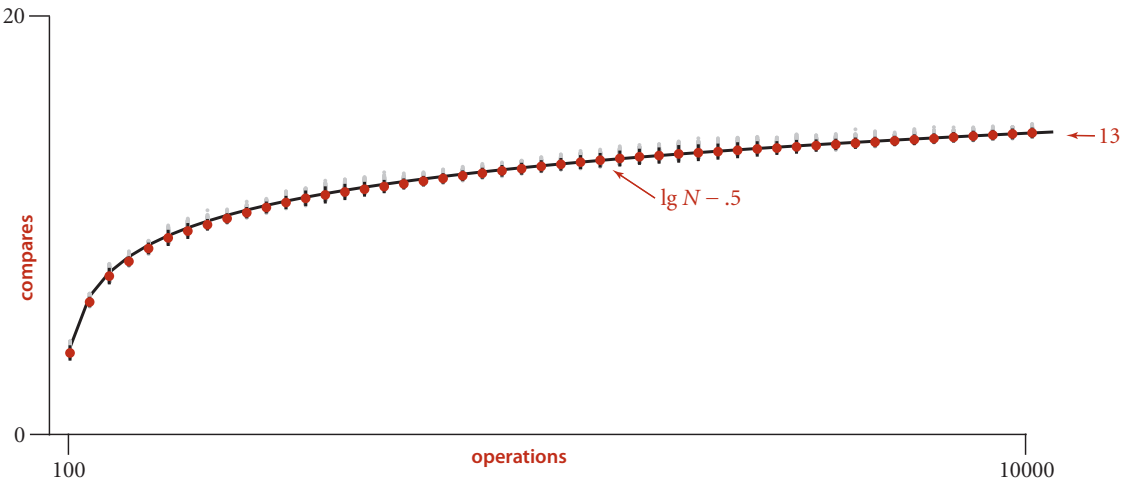

Average path length to a random node in a red-black BST built from random keys

This page intentionally left blank

3.4 HASH TABLES

If keys are small integers, we can use an array to implement an unordered symbol table, by interpreting the key as an array index so that we can store the value associated with key i in array entry i , ready for immediate access. In this section, we consider *hashing*, an extension of this simple method that handles more complicated types of keys. We reference key-value pairs using arrays by doing arithmetic operations to transform keys into array indices.

Search algorithms that use hashing consist of two separate parts. The first part is to compute a *hash function* that transforms the search key into an array index. Ideally, different keys would map to different indices. This ideal is generally beyond our reach, so we have to face the possibility that two or more different keys may hash to the same array index. Thus, the second part of a hashing search is a *collision-resolution* process that deals with this situation. After describing ways to compute hash functions, we shall consider two different approaches to collision resolution: *separate chaining* and *linear probing*.

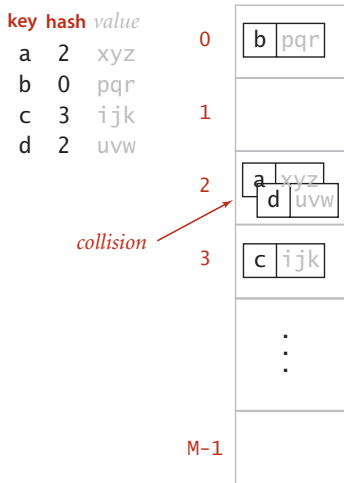

Hashing: the crux of the problem

Hashing is a classic example of a *time-space tradeoff*. If there were no memory limitation, then we could do any search with only one memory access by simply using the key as an index in a (potentially huge) array. This ideal often cannot be achieved, however, because the amount of memory required is prohibitive when the number of possible key values is huge. On the other hand, if there were no time limitation, then we can get by with only a minimum amount of memory by using sequential search in an unordered array. Hashing provides a way to use a reasonable amount of both memory and time to strike a balance between these two extremes. Indeed, it turns out that we can trade off time

and memory in hashing algorithms by adjusting parameters, not by rewriting code. To help choose values of the parameters, we use classical results from probability theory.

Probability theory is a triumph of mathematical analysis that is beyond the scope of this book, but the hashing algorithms we consider that take advantage of the knowledge gained from that theory are quite simple, and widely used. With hashing, you can implement search and insert for symbol tables that require *constant* (amortized) time per operation in typical applications, making it the method of choice for implementing basic symbol tables in many situations.

Hash functions The first problem that we face is the computation of the hash function, which transforms keys into array indices. If we have an array that can hold M key-value pairs, then we need a *hash function* that can transform any given key into an index into that array: an integer in the range $[0, M-1]$. We seek a hash function that both is easy to compute and uniformly distributes the keys: for each key, every integer between 0 and $M-1$ should be equally likely (independently for every key). This ideal is somewhat mysterious; to understand hashing, it is worthwhile to begin by thinking carefully about how to implement such a function.

The hash function depends on the key type. Strictly speaking, *we need a different hash function for each key type that we use*. If the key involves a number, such as a social security number, we could start with that number; if the key involves a string, such as a person's name, we need to convert the string into a number; and if the key has multiple parts, such as a mailing address, we need to combine the parts somehow. For many common types of keys, we can make use of default implementations provided by Java. We briefly discuss potential implementations for various types of keys so that you can see what is involved because you do need to provide implementations for key types that you create.

Typical example. Suppose that we have an application where the keys are U.S. social security numbers. A social security number such as 123-45-6789 is a nine-digit number divided into three fields. The first field identifies the geographical area where the number was issued (for example, social security numbers whose first field is 035 are from Rhode Island and numbers whose first field is 214 are from Maryland) and the other two fields identify the individual. There are a billion (10^9) different social security numbers, but suppose that our application will need to process just a few hundred keys, so that we could use a hash table of size $M = 1,000$. One possible approach to implementing a hash function is to use three digits from the key. Using three digits from the third field is likely to be preferable to using the three digits in the first field (since customers may not be uniformly dispersed over geographic areas), but a better approach is to use all nine digits to make an `int` value, then consider hash functions for integers, described next.

Positive integers. The most commonly used method for hashing integers is called *modular hashing*: we choose the array size M to be prime and, for any positive integer key k , compute the remainder when dividing k by M . This function is very easy to compute (`k % M`, in Java) and is effective in dispersing the keys evenly between 0 and

key	hash ($M = 100$)	hash ($M = 97$)
212	12	18
618	18	36
302	2	11
940	40	67
702	2	23
704	4	25
612	12	30
606	6	24
772	72	93
510	10	25
423	23	35
650	50	68
317	17	26
907	7	34
507	7	22
304	4	13
714	14	35
857	57	81
801	1	25
900	0	27
413	13	25
701	1	22
418	18	30
601	1	19

Modular hashing

$M - 1$. If M is not prime, it may be the case that not all of the bits of the key play a role, which amounts to missing an opportunity to disperse the values evenly. For example, if the keys are base-10 numbers and M is 10^k , then only the k least significant digits are used. As a simple example where such a choice might be problematic, suppose that the keys are telephone area codes and $M = 100$. For historical reasons, most area codes in the United States have middle digit 0 or 1, so this choice strongly favors the values less than 20, where the use of the prime value 97 better disperses them (a prime value not close to 100 would do even better). Similarly, IP addresses that are used in the internet are binary numbers that are not random for similar historical reasons as for telephone area codes, so we need to use a table size that is a prime (in particular, *not* a power of 2) if we want to use modular hashing to disperse them.

Floating-point numbers. If the keys are real numbers between 0 and 1, we might just multiply by M and round off to the nearest integer to get an index between 0 and $M - 1$. Although this approach is intuitive, it is defective because it gives more weight to the most significant bits of the keys; the least significant bits play no role. One way to address this situation is to use modular hashing on the binary representation of the key (this is what Java does).

Strings. Modular hashing works for long keys such as strings, too: we simply treat them as huge integers. For example, the code at left computes a modular hash function for a `String` `s`: recall that `charAt()` returns a `char` value in Java, which is a 16-bit nonnegative integer. If R is greater than any character value, this computation would

```
int hash = 0;
for (int i = 0; i < s.length(); i++)
    hash = (R * hash + s.charAt(i)) % M;
```

Hashing a string key

be equivalent to treating the `String` as an N -digit base- R integer, computing the remainder that results when dividing that number by M . A classic algorithm known as *Horner's method* gets the job done with N multiplications, additions, and modulus operations. If the value of R is sufficiently

small that no overflow occurs, the result is an integer between 0 and $M - 1$, as desired. The use of a small prime integer such as 31 ensures that the bits of all the characters play a role. Java's default implementation for `String` uses a method like this.

Compound keys. If the key type has multiple integer fields, we can typically mix them together in the way just described for `String` values. For example, suppose that search keys are of type `Date`, which has three integer fields: `day` (two-digit day), `month` (two-digit month), and `year` (four-digit year). We compute the number

```
int hash = (((day * R + month) % M) * R + year) % M;
```

which, if the value of R is sufficiently small that no overflow occurs, is an integer between 0 and $M-1$, as desired. In this case, we could save the cost of the inner $\% M$ operation by choosing a moderate prime value such as 31 for R . As with strings, this method generalizes to handle any number of fields.

Java conventions. Java helps us address the basic problem that every type of data needs a hash function by ensuring that every data type inherits a method called `hashCode()` that returns a 32-bit integer. The implementation of `hashCode()` for a data type must be *consistent with equals*. That is, if `a.equals(b)` is true, then `a.hashCode()` must have the same numerical value as `b.hashCode()`. Conversely, if the `hashCode()` values are different, then we know that the objects are not equal. If the `hashCode()` values are the same, the objects may or may not be equal, and we must use `equals()` to decide which condition holds. This convention is a basic requirement for clients to be able to use `hashCode()` for symbol tables. Note that it implies that you must override both `hashCode()` and `equals()` if you need to hash with a user-defined type. The default implementation returns the machine address of the key object, which is seldom what you want. Java provides `hashCode()` implementations that override the defaults for many common types (including `String`, `Integer`, `Double`, `File`, and `URL`).

Converting a `hashCode()` to an array index. Since our goal is an array index, not a 32-bit integer, we combine `hashCode()` with modular hashing in our implementations to produce integers between 0 and $M-1$, as follows:

```
private int hash(Key x)
{   return (x.hashCode() & 0x7fffffff) % M; }
```

This code masks off the sign bit (to turn the 32-bit number into a 31-bit nonnegative integer) and then computes the remainder when dividing by M , as in modular hashing. Programmers commonly use a *prime* number for the hash table size M when using code like this, to attempt to make use of all the bits of the hash code. *Note:* To avoid confusion, we omit all of these calculations in our hashing examples and use instead the hash values in the table at right.

key	S	E	A	R	C	H	X	M	P	L
hash (M = 5)	2	0	0	4	4	4	2	4	3	3
hash (M = 16)	6	10	4	14	5	4	15	1	14	6

Hash values for keys in examples

User-defined `hashCode()`. Client code expects that `hashCode()` disperses the keys uniformly among the possible 32-bit result values. That is, for any object x , you can write `x.hashCode()` and, in principle, expect to get any one of the 2^{32} possible 32-bit values with equal likelihood. Java's `hashCode()` implementations for `String`, `Integer`, `Double`, `File`, and `URL` aspire to this functionality; for your own type, you have to try to do it on your own. The `Date` example that we considered on page 460 illustrates

```

public class Transaction
{
    ...
    private final String who;
    private final Date when;
    private final double amount;

    public int hashCode()
    {
        int hash = 17;
        hash = 31 * hash + who.hashCode();
        hash = 31 * hash + when.hashCode();
        hash = 31 * hash
            + ((Double) amount).hashCode();
        return hash;
    }
    ...
}

```

Implementing hashCode() in a user-defined type

one way to proceed: make integers from the instance variables and use modular hashing. In Java, the convention that all data types inherit a hashCode() method enables an even simpler approach: use the hashCode() method for the instance variables to convert each to a 32-bit int value and then do the arithmetic, as illustrated at left for Transaction. For primitive-type instance variables, note that a cast to a wrapper type is necessary to access the hashCode() method. Again, the precise values of the multiplier (31 in our example) is not particularly important.

Software caching. If computing the hash code is expensive, it may be worthwhile to

cache the hash for each key. That is, we maintain an instance variable hash in the key type that contains the value of hashCode() for each key object (see EXERCISE 3.4.25). On the first call to hashCode(), we have to compute the full hash code (and set the value of hash), but subsequent calls on hashCode() simply return the value of hash. Java uses this technique to reduce the cost of computing hashCode() for String objects.

IN SUMMARY, WE HAVE THREE PRIMARY REQUIREMENTS in implementing a good hash function for a given data type:

- It should be *consistent*—equal keys must produce the same hash value.
- It should be *efficient to compute*.
- It should *uniformly distribute the keys*.

Satisfying these requirements simultaneously is a job for experts. As with many built-in capabilities, Java programmers who use hashing assume that hashCode() does the job, absent any evidence to the contrary.

Still, you should be vigilant whenever using hashing in situations where good performance is critical, because a bad hash function is a classic example of a *performance bug*: everything will work properly, but much more slowly than expected. Perhaps the easiest way to ensure uniformity is to make sure that all the bits of the key play an equal role in computing every hash value; perhaps the most common mistake in implementing hash functions is to ignore significant numbers of the key bits. Whatever the implementation, it is wise to test any hash function that you use, when performance is important. Which takes more time: computing a hash function or comparing two keys? Does your

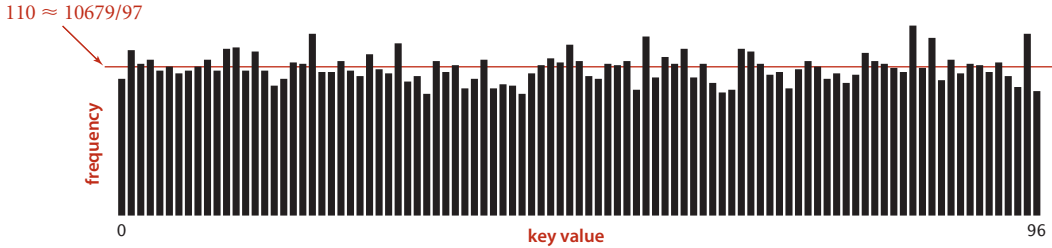

Hash value frequencies for words in *Tale of Two Cities* (10,679 keys, $M = 97$)

hash function spread a typical set of keys uniformly among the values between 0 and $M-1$? Doing simple experiments that answer these questions can protect future clients from unfortunate surprises. For example, the histogram above shows that our `hash()` implementation using the `hashCode()` from Java's `String` data type produces a reasonable dispersion of the words for our *Tale of Two Cities* example.

Underlying this discussion is a fundamental assumption that we make when using hashing, an idealized model that we do not actually expect to achieve, but that guides our thinking when implementing hashing algorithms:

Assumption J (*uniform hashing assumption*). The hash functions that we use uniformly and independently distribute keys among the integer values between 0 and $M-1$.

Discussion: With all of the arbitrary choices that we have made, we certainly do not have hash functions that uniformly and independently distribute keys in this strict mathematical sense. Indeed, the idea of implementing consistent functions that are guaranteed to uniformly and independently distribute keys leads to deep theoretical studies that tell us that computing such a function easily is likely to be a very elusive goal. In practice, as with random numbers generated by `Math.random()`, most programmers are content to have hash functions that cannot easily be distinguished from random ones. Few programmers check for independence, however, and this property is rarely satisfied.

DESPITE THE DIFFICULTY OF VALIDATING IT, ASSUMPTION J is a useful way to think about hashing for two primary reasons. First, it is a worthy goal when designing hash functions that guides us away from making arbitrary decisions that might lead to an excessive number of collisions. Second, even though we may not be able to validate the assumption itself, it does enable us to use mathematical analysis to develop hypotheses about the performance of hashing algorithms that we can check with experiments.

Hashing with separate chaining A hash function converts keys into array indices. The second component of a hashing algorithm is *collision resolution*: a strategy for handling the case when two or more keys to be inserted hash to the same index. A straightforward and general approach to collision resolution is to build, for each of the M array indices, a linked list of the key-value pairs whose keys hash to that index. This method is known as *separate chaining* because items that collide are chained together in separate linked lists. The basic idea is to choose M to be sufficiently large that the lists are sufficiently short to enable efficient search through a two-step process: hash to find the list that could contain the key, then sequentially search through that list for the key.

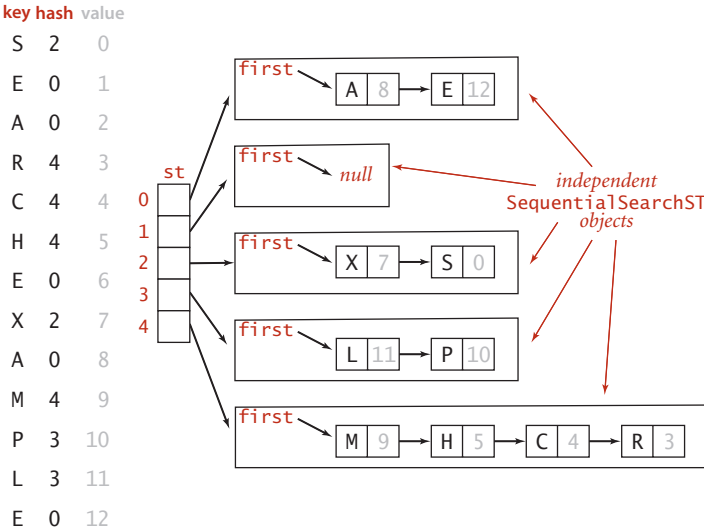

Hashing with separate chaining for standard indexing client

One way to proceed is to expand `SequentialSearchST` (ALGORITHM 3.1) to implement separate chaining using linked-list primitives (see EXERCISE 3.4.2). A simpler (though slightly less efficient) way to proceed is to adopt a more general approach: we build, for each of the M array indices, a *symbol table* of the keys that hash to that index, thus reusing code that we have already developed. The implementation `SeparateChainingHashST` in ALGORITHM 3.5 maintains an array of `SequentialSearchST` objects and implements `get()` and `put()` by computing a hash function to choose which

`SequentialSearchST` object can contain the key and then using `get()` and `put()` (respectively) from `SequentialSearchST` to complete the job.

Since we have M lists and N keys, the average length of the lists is *always* N/M , no matter how the keys are distributed among the lists. For example, suppose that all the items fall onto the first list—the average length of the lists is $(N+0+0+0+\dots+0)/M = N/M$. However the keys are distributed on the lists, the sum of the list lengths is N and the average is N/M . Separate chaining is useful in practice because *each* list is *extremely likely* to have about N/M key-value pairs. In typical situations, we can verify this consequence of ASSUMPTION J and count on fast search and insert.

ALGORITHM 3.5 Hashing with separate chaining

```

public class SeparateChainingHashST<Key, Value>
{
    private int N;                // number of key-value pairs
    private int M;                // hash table size
    private SequentialSearchST<Key, Value>[] st; // array of ST objects

    public SeparateChainingHashST()
    { this(997); }

    public SeparateChainingHashST(int M)
    { // Create M linked lists.
      this.M = M;
      st = (SequentialSearchST<Key, Value>[]) new SequentialSearchST[M];
      for (int i = 0; i < M; i++)
        st[i] = new SequentialSearchST();
    }

    private int hash(Key key)
    { return (key.hashCode() & 0x7fffffff) % M; }

    public Value get(Key key)
    { return (Value) st[hash(key)].get(key); }

    public void put(Key key, Value val)
    { st[hash(key)].put(key, val); }

    public Iterable<Key> keys()
    // See Exercise 3.4.19.
}

```

This basic symbol-table implementation maintains an array of linked lists, using a hash function to choose a list for each key. For simplicity, we use `SequentialSearchST` methods. We need a cast when creating `st[]` because Java prohibits arrays with generics. The default constructor specifies 997 lists, so that for large tables, this code is about a factor of 1,000 faster than `SequentialSearchST`. This quick solution is an easy way to get good performance when you have some idea of the number of key-value pairs to be `put()` by a client. A more robust solution is to use array resizing to make sure that the lists are short no matter how many key-value pairs are in the table (see page 474 and EXERCISE 3.4.18).

Proposition K. In a separate-chaining hash table with M lists and N keys, the probability (under ASSUMPTION J) that the number of keys in a list is within a small constant factor of N/M is extremely close to 1.

Proof sketch: ASSUMPTION J makes this an application of classical probability theory. We sketch the proof, for readers who are familiar with basic probabilistic analysis. The probability that a given list will contain exactly k keys is given by the *binomial distribution*

$$\binom{N}{k} \left(\frac{1}{M}\right)^k \left(\frac{M-1}{M}\right)^{N-k}$$

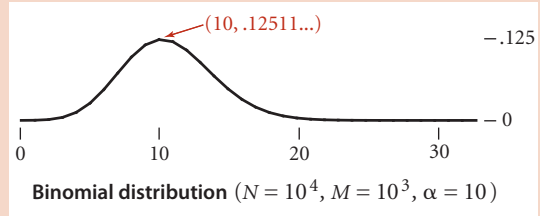

by the following argument: Choose k out of the N keys. Those k keys hash to the given list with probability $1/M$, and the other $N - k$ keys do not hash to the given list with probability $1 - (1/M)$. In terms of $\alpha = N/M$, we can rewrite this expression as

$$\binom{N}{k} \left(\frac{\alpha}{N}\right)^k \left(1 - \frac{\alpha}{N}\right)^{N-k}$$

which (for small α) is closely approximated by the classical *Poisson distribution*

$$\frac{\alpha^k e^{-\alpha}}{k!}$$

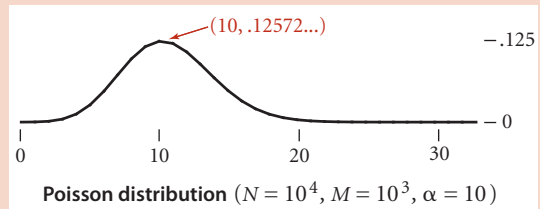

It follows that the probability that a list has more than $t\alpha$ keys on it is bounded by the quantity $(\alpha e/t)^t e^{-\alpha}$. This probability is extremely small for practical ranges of the parameters. For example, if the average length of the lists is 10, the probability that we will hash to some list with more than 20 keys on it is less than $(10 e/2)^2 e^{-10} \approx 0.0084$, and if the average length of the lists is 20, the probability that we will hash to some list with more than 40 keys on it is less than $(20 e/2)^2 e^{-20}$

0.0000016. This concentration result does not guarantee that *every* list will be short. Indeed it is known that, if α is a constant, the average length of the longest list grows with $\log N / \log \log N$.

This classical mathematical analysis is compelling, but it is important to note that it *completely depends* on ASSUMPTION J. If the hash function is not uniform and independent, the search and insert cost could be proportional to N , no better than with sequential search. ASSUMPTION J is much stronger than the corresponding assumption for other probabilistic algorithms that we have seen, and much more difficult to verify. With hashing, we are assuming that each and every key, no matter how complex, is equally likely to be hashed to one of M indices. We cannot afford to run experiments to test every possible key, so we would have to do more sophisticated experiments involving random sampling from the set of possible keys used in an application, followed by statistical analysis. Better still, we can use the algorithm itself as part of the test, to validate both ASSUMPTION J and the mathematical results that we derive from it.

Property L. In a separate-chaining hash table with M lists and N keys, the number of compares (equality tests) for search miss and insert is $\sim N/M$.

Evidence: Good performance of the algorithms in practice does not require the hash function to be fully uniform in the technical sense of ASSUMPTION J. Countless programmers since the 1950s have seen the speedups predicted by PROPOSITION K, even for hash functions that are certainly not uniform. For example, the diagram on page 468 shows that list length distribution for our `FrequencyCounter` example (using our `hash()` implementation based on the `hashCode()` from Java's `String` data type) precisely matches the theoretical model. One exception that has been documented on numerous occasions is poor performance due to hash functions not taking all of the bits of the keys into account. Otherwise, the preponderance of the evidence from the experience of practical programmers puts us on solid ground in stating that hashing with separate chaining using an array of size M speeds up search and insert in a symbol table by a factor of M .

Table size. In a separate-chaining implementation, our goal is to choose the table size M to be sufficiently small that we do not waste a huge area of contiguous memory with empty chains but sufficiently large that we do not waste time searching through long chains. One of the virtues of separate chaining is that this decision is not critical: if more keys arrive than expected, then searches will take a little longer than if we had chosen a bigger table size ahead of time; if fewer keys are in the table, then we have extra-fast search with some wasted space. When space is not a critical resource, M can be chosen sufficiently large that search time is constant; when space is a critical resource, we still can get a factor of M improvement in performance by choosing M to be as

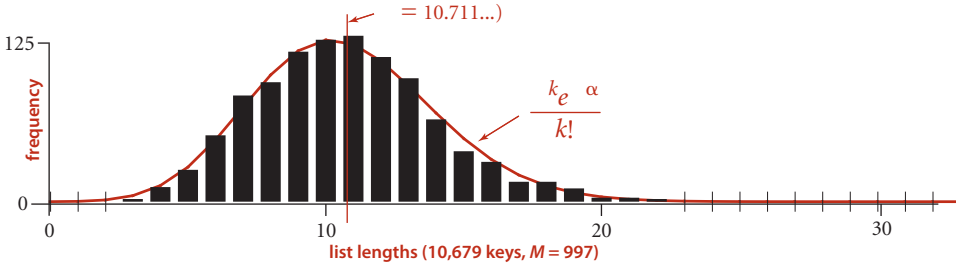

List lengths for java FrequencyCounter 8 < tale.txt using SeparateChainingHashST

large as we can afford. For our example FrequencyCounter study, we see in the figure below a reduction in the average cost from thousands of compares per operation for SequentialSearchST to a small constant for SeparateChainingHashST, as expected. Another option is to use array resizing to keep the lists short (see EXERCISE 3.4.18).

Deletion. To delete a key-value pair, simply hash to find the SequentialSearchST containing the key, then invoke the delete() method for that table (see EXERCISE 3.1.5). Reusing code in this way is preferable to reimplementing this basic operation on linked lists.

Ordered operations. The whole point of hashing is to uniformly disperse the keys, so any order in the keys is lost when hashing. If you need to quickly find the maximum or minimum key, find keys in a given range, or implement any of the other operations in the ordered symbol-table API on page 366, then hashing is *not* appropriate, since these operations will all take linear time.

HASHING WITH SEPARATE CHAINING is easy to implement and probably the fastest (and most widely used) symbol-table implementation for applications where key order is not important. When your keys are built-in Java types or your own type with well-tested implementations of hashCode(), ALGORITHM 3.5 provides a quick and easy path to fast search and insert. Next, we consider an alternative scheme for collision resolution that is also effective.

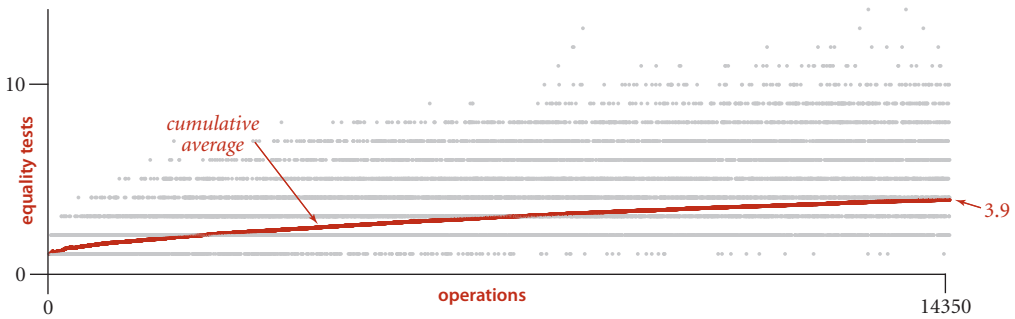

Costs for java FrequencyCounter 8 < tale.txt using SeparateChainingHashST (M = 997)

Hashing with linear probing Another approach to implementing hashing is to store N key-value pairs in a hash table of size $M > N$, relying on empty entries in the table to help with collision resolution. Such methods are called *open-addressing* hashing methods.

The simplest open-addressing method is called *linear probing*: when there is a collision (when we hash to a table index that is already occupied with a key different from the search key), then we just check the next entry in the table (by incrementing the index). Linear probing is characterized by identifying three possible outcomes:

- Key equal to search key: search hit
- Empty position (null key at indexed position): search miss
- Key not equal to search key: try next entry

We hash the key to a table index, check whether the search key matches the key there, and continue (incrementing the index, wrapping back to the beginning of the table if we reach the end) until finding either the search key or an empty table entry. It is customary to refer to the operation of determining whether or not a given table entry

key	hash	value	0	1	2	3	4	5	6	7	8	9	10	11	12	13	14	15
S	6	0							S									
E	10	1							S				E					
A	4	2					A		S				E					
R	14	3					A		S				E				R	
C	5	4					A	C	S				E				R	
H	4	5					A	C	S	H			E				R	
E	10	6					A	C	S	H			E				R	
X	15	7					A	C	S	H			E				R	X
A	4	8					A	C	S	H			E				R	X
M	1	9		M			A	C	S	H			E				R	X
P	14	10	P	M			A	C	S	H			E				R	X
L	6	11	P	M			A	C	S	H	L		E				R	X
E	10	12	P	M			A	C	S	H	L		E				R	X

entries in red are new → (A, 2) entries in gray are untouched → (E, 1)
keys in black are probes → (A, 2), (C, 5), (S, 0), (H, 5)
probe sequence wraps to 0 → (M, 9) → (P, 10) → (L, 11) → (E, 12)
keys[] → (A, C, S, H, L) vals[] → (2, 5, 0, 5, 11)

Trace of linear-probing ST implementation for standard indexing client

ALGORITHM 3.6 Hashing with linear probing

```

public class LinearProbingHashST<Key, Value>
{
    private int N;           // number of key-value pairs in the table
    private int M = 16;     // size of linear-probing table
    private Key[] keys;     // the keys
    private Value[] vals;   // the values

    public LinearProbingHashST()
    {
        keys = (Key[]) new Object[M];
        vals = (Value[]) new Object[M];
    }

    private int hash(Key key)
    { return (key.hashCode() & 0x7fffffff) % M; }

    private void resize() // See page 474.

    public void put(Key key, Value val)
    {
        if (N >= M/2) resize(2*M); // double M (see text)

        int i;
        for (i = hash(key); keys[i] != null; i = (i + 1) % M)
            if (keys[i].equals(key)) { vals[i] = val; return; }
        keys[i] = key;
        vals[i] = val;
        N++;
    }

    public Value get(Key key)
    {
        for (int i = hash(key); keys[i] != null; i = (i + 1) % M)
            if (keys[i].equals(key))
                return vals[i];
        return null;
    }
}

```

This symbol-table implementation keeps keys and values in parallel arrays (as in `BinarySearchST`) but uses empty spaces (marked by `null`) to terminate clusters of keys. If a new key hashes to an empty entry, it is stored there; if not, we scan sequentially to find an empty position. To search for a key, we scan sequentially starting at its hash index until finding `null` (search miss) or the key (search hit). Implementation of `keys()` is left as EXERCISE 3.4.19.

holds an item whose key is equal to the search key as a *probe*. We use the term interchangeably with the term *compare* that we have been using, even though some probes are tests for `null`.

The essential idea behind hashing with open addressing is this: rather than using memory space for references in linked lists, we use it for the empty entries in the hash table, which mark the ends of probe sequences. As you can see from `LinearProbingHashST` (ALGORITHM 3.6), applying this idea to implement the symbol-table API is quite straightforward. We implement the table with parallel arrays, one for the keys and one for the values, and use the hash function as an index to access the data as just discussed.

Deletion. How do we delete a key-value pair from a linear-probing table? If you think about the situation for a moment, you will see that setting the key's table position to `null` will not work, because that might prematurely terminate the search for a key that was inserted into the table later. As an example, suppose that we try to delete C in this way in our trace example, then search for H. The hash value for H is 4, but it sits at the end of the cluster, in position 7. If we set position 5 to `null`, then `get()` will not find H. As a consequence, we need to reinsert into the table all of the keys in the cluster to the right of the deleted key. This process is trickier than it might seem, so you are encouraged to trace through the code at right for an example that exercises it (see EXERCISE 3.4.17).

AS WITH SEPARATE CHAINING, the performance of hashing with open addressing depends on the ratio $= N/M$, but we interpret it differently. We refer

to α as the *load factor* of a hash table. For separate chaining, α is the average number of keys per list and is generally larger than 1; for linear probing,

is the percentage of table entries that are occupied; it cannot be greater than 1. In fact, we cannot let the load factor reach 1 (completely full table)

in `LinearProbingHashST` because a search miss would go into an infinite loop in a full table. In-

deed, for the sake of good performance, we use array resizing to guarantee that the load factor is between one-eighth and one-half. This strategy is validated by mathematical analysis, which we consider before we discuss implementation details.

```
public void delete(Key key)
{
    if (!contains(key)) return;
    int i = hash(key);
    while (!key.equals(keys[i]))
        i = (i + 1) % M;
    keys[i] = null;
    vals[i] = null;
    i = (i + 1) % M;
    while (keys[i] != null)
    {
        Key keyToRedo = keys[i];
        Value valToRedo = vals[i];
        keys[i] = null;
        vals[i] = null;
        N--;
        put(keyToRedo, valToRedo);
        i = (i + 1) % M;
    }
    N--;
    if (N > 0 && N == M/8) resize(M/2);
}
```

Deletion for linear probing

Clustering. The average cost of linear probing depends on the way in which the entries clump together into contiguous groups of occupied table entries, called *clusters*, when they are inserted.

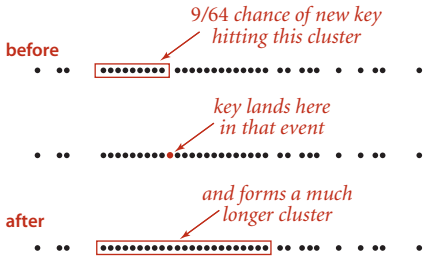

Clustering in linear probing ($M = 64$)

For example, when the key C is inserted in our example, the result is a cluster (A C S) of length 3, which means that four probes are needed to insert H because H hashes to the first position in the cluster. Short clusters are certainly a requirement for efficient performance. This requirement can be problematic as the table fills, because long clusters are common. Moreover, since all table positions are equally likely to be the hash value of the next key to be inserted (under the uniform hashing assumption), long clusters are *more likely* to increase in length than short ones, because a new key hashing to any entry in the cluster will cause the cluster to increase

in length by 1 (and possibly much more, if there is just one table entry separating the cluster from the next one). Next, we turn to the challenge of quantifying the effect of clustering to predict performance in linear probing, and using that knowledge to set design parameters in our implementations.

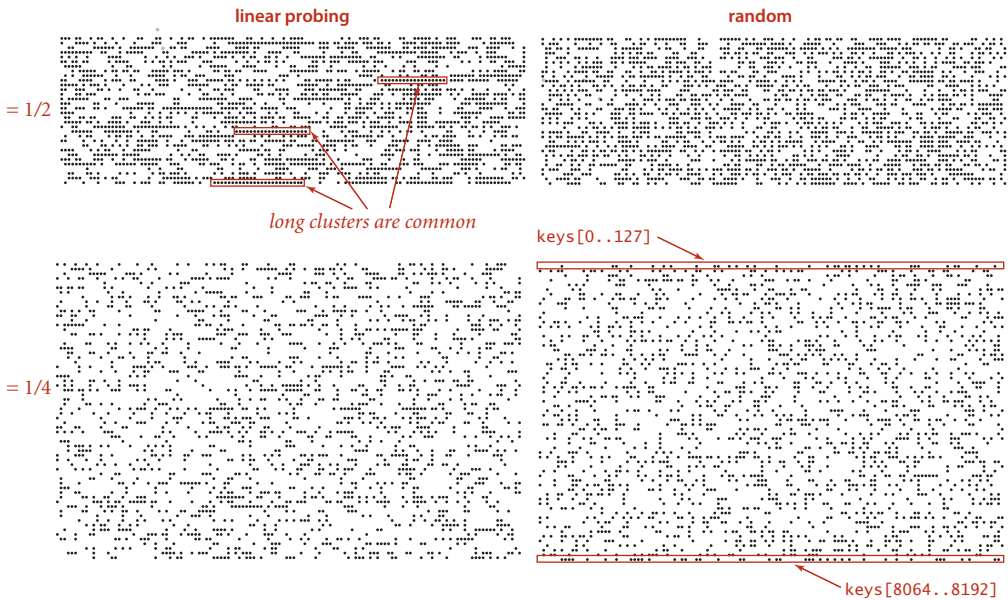

Table occupancy patterns (2,048 keys, tables laid out in 128-position rows)

Analysis of linear probing. Despite the relatively simple form of the results, precise analysis of linear probing is a very challenging task. Knuth's derivation of the following formulas in 1962 was a landmark in the analysis of algorithms:

Proposition M. In a linear-probing hash table with M lists and $N = \alpha M$ keys, the average number of probes (under ASSUMPTION J) required is

$$\sim \frac{1}{2} \left(1 + \frac{1}{1 - \alpha} \right) \quad \text{and} \quad \sim \frac{1}{2} \left(1 + \frac{1}{(1 - \alpha)^2} \right)$$

for search hits and search misses (or inserts), respectively. In particular, when α is about $1/2$, the average number of probes for a search hit is about $3/2$ and for a search miss is about $5/2$. These estimates lose a bit of precision as α approaches 1, but we do not need them for that case, because we will only use linear probing for less than one-half.

Discussion: We compute the average by computing the cost of a search miss starting at each position in the table, then dividing the total by M . All search misses take at least 1 probe, so we count the number of probes after the first. Consider the following two extremes in a linear-probing table that is half full ($M = 2N$): In the best case, table positions with even indices could be empty, and table positions with odd indices could be occupied. In the worst case, the first half of the table positions could be empty, and the second half occupied. The average length of the clusters in both cases is $N/(2N) = 1/2$, but the average number of probes for a search miss is 1 (all searches take at least 1 probe) plus $(0 + 1 + 0 + 1 + \dots)/(2N) = 1/2$ in the best case, and is 1 plus $(N + (N - 1) + \dots)/(2N) \sim N/4$ in the worst case. This argument generalizes to show that the average number of probes for a search miss is proportional to the *squares* of the lengths of the clusters: If a cluster is of length t , then the expression $(t + (t - 1) + \dots + 2 + 1) / M = t(t + 1)/(2M)$ counts the contribution of that cluster to the grand total. The sum of the cluster lengths is N , so, adding this cost for all entries in the table, we find that the total average cost for a search miss is $1 + N/(2M)$ plus the sum of the squares of the lengths of the clusters, divided by $2M$. Thus, given a table, we can quickly compute the average cost of a search miss in that table (see EXERCISE 3.4.21). In general, the clusters are formed by a complicated dynamic process (the linear-probing algorithm) that is difficult to characterize analytically, and quite beyond the scope of this book.

PROPOSITION M tells us (under our usual ASSUMPTION J) that we can expect a search to require a huge number of probes in a nearly full table (as α approaches 1 the values of the formulas describing the number of probes grow very large) but that the expected number of probes is between 1.5 and 2.5 if we can ensure that the load factor α is less than $1/2$. Next, we consider the use of array resizing for this purpose.

Array resizing We can use our standard array-resizing technique from CHAPTER 1 to ensure that the load factor never exceeds one-half. First, we need a new constructor for `LinearProbingHashST` that takes a fixed capacity as argument (add a line to

the constructor in ALGORITHM 3.6 that sets M to the given value before creating the arrays). Next, we need the `resize()` method given at left, which creates a new `LinearProbingHashST` of the given size, puts all the keys and values in the table in the new one, then rehashes all the keys into the new table. These additions allow us to implement array doubling. The call to `resize()` in the first statement in `put()` ensures that the table is at

```
private void resize(int cap)
{
    LinearProbingHashST<Key, Value> t;
    t = new LinearProbingHashST<Key, Value>(cap);
    for (int i = 0; i < M; i++)
        if (keys[i] != null)
            t.put(keys[i], vals[i]);
    keys = t.keys;
    vals = t.vals;
    M = t.M;
}
```

Resizing a linear-probing hash table

most one-half full. This code builds a hash table twice the size with the same keys, thus halving the value of α . As in other applications of array resizing, we also need to add

```
if (N > 0 && N <= M/8) resize(M/2);
```

as the last statement in `delete()` to ensure that the table is at least one-eighth full. This ensures that the amount of memory used is always within a constant factor of the number of key-value pairs in the table. With array resizing, we are assured that $\alpha \leq 1/2$.

Separate chaining. The same method works to keep lists short (of average length between 2 and 8) in separate chaining: replace `LinearProbingHashST` by `SeparateChainingHashST` in `resize()`, call `resize(2*M)` when $(N \geq M/2)$ in `put()`, and call `resize(M/2)` when $(N > 0 \ \&\& \ N \leq M/8)$ in `delete()`. For separate chaining, array resizing is *optional* and not worth your trouble if you have a decent estimate of the client's N : just pick a table size M based on the knowledge that search times are proportional to $1 + N/M$. For linear probing, array resizing is *necessary*. A client that inserts more key-value pairs than you expect will encounter not just excessively long search times, but an infinite loop when the table fills.

Amortized analysis. From a theoretical standpoint, when we use array resizing, we must settle for an amortized bound, since we know that those insertions that cause the table to double will require a large number of probes.

Proposition N. Suppose a hash table is built with array resizing, starting with an empty table. Under ASSUMPTION J, any sequence of t *search*, *insert*, and *delete* symbol-table operations is executed in expected time proportional to t and with memory usage always within a constant factor of the number of keys in the table.

Proof.: For both separate chaining and linear probing, this fact follows from a simple restatement of the amortized analysis for array growth that we first discussed in CHAPTER 1, coupled with PROPOSITION K and PROPOSITION M.

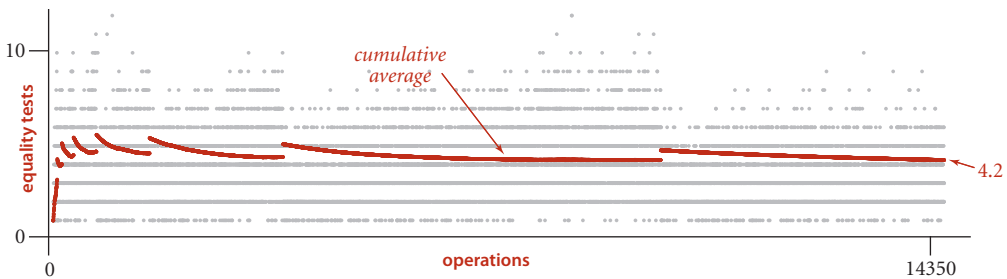

Costs for java FrequencyCounter 8 < tale.txt using SeparateChainingHashST (with doubling)

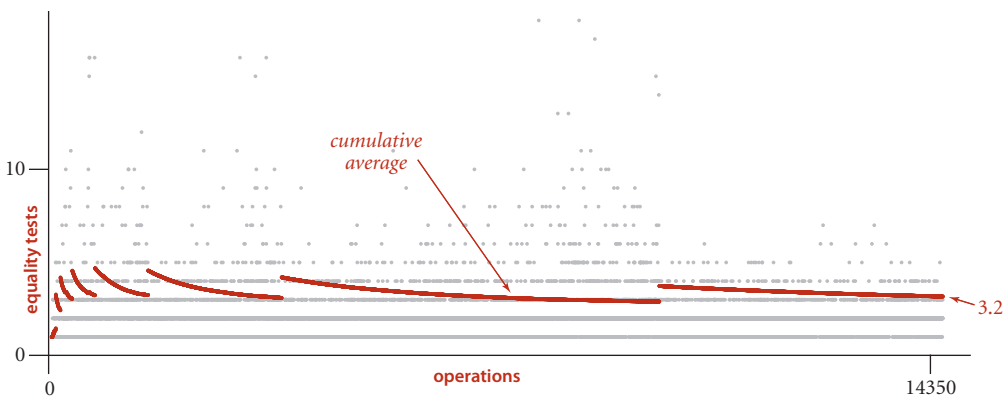

Costs for java FrequencyCounter 8 < tale.txt using LinearProbingHashST (with doubling)

The plots of the cumulative averages for our `FrequencyCounter` example (shown at the bottom of the previous page) nicely illustrate the dynamic behavior of array resizing in hashing. Each time the array doubles, the cumulative average increases by about 1, because each key in the table needs to be rehashed; then it decreases because about half as many keys hash to each table position, with the rate of decrease slowing as the table fills again.

Memory As we have indicated, understanding memory usage is an important factor if we want to tune hashing algorithms for optimum performance. While such tuning is for experts, it is a worthwhile exercise to calculate a rough estimate of the amount of memory required, by estimating the number of references used, as follows: Not counting the memory for keys and values, our implementation `SeparateChainingHashST` uses memory for M references to `SequentialSearchST` objects plus M `SequentialSearchST` objects. Each `SequentialSearchST` object has the usual 16 bytes of object overhead plus one 8-byte reference (`first`), and there are a total of N `Node` objects, each with 24 bytes of object overhead plus 3 references (`key`, `value`, and `next`). This compares with an extra reference per node for binary search trees. With array resizing to ensure that the table is between one-eighth and one-half full, linear probing uses between $4N$ and $16N$ references. Thus, choosing hashing on the basis of memory usage is not normally justified. The calculation is a bit different for primitive types (see EXERCISE 3.4.24)

method	space usage for N items (reference types)
<i>separate chaining</i>	$\sim 48N + 64M$
<i>linear probing</i>	between $\sim 32N$ and $\sim 128N$
<i>BSTs</i>	$\sim 56N$

Space usage in symbol tables

SINCE THE EARLIEST DAYS OF COMPUTING, researchers have studied (and are studying) hashing and have found many ways to improve the basic algorithms that we have discussed. You can find a huge literature on the subject. Most of the improvements push down the space-time curve: you can get the same running time for searches using less space or get faster searches using the same amount of space. Other improvements involve better guarantees, on the expected worst-case cost of a search. Others involve improved hash-function designs. Some of these methods are addressed in the exercises.

Detailed comparison of separate chaining and linear probing depends on myriad implementation details and on client space and time requirements. It is not normally justified to choose separate chaining over linear probing on the basis of performance (see EXERCISE 3.5.31). In practice, the primary performance difference between the two methods has to do with the fact that separate chaining uses a small block of memory for each key-value pair, while linear probing uses two large arrays for the whole table. For huge tables, these needs place quite different burdens on the memory management system. In modern systems, this sort of tradeoff is best addressed by experts in extreme performance-critical situations.

With hashing, under generous assumptions, it is not unreasonable to expect to support the search and insert symbol-table operations in constant time, independent of the size of the table. This expectation is the theoretical optimum performance for any symbol-table implementation. Still, hashing is not a panacea, for several reasons, including:

- A good hash function for each type of key is required.
- The performance guarantee depends on the quality of the hash function.
- Hash functions can be difficult and expensive to compute.
- Ordered symbol-table operations are not easily supported.

Beyond these basic considerations, we defer the comparison of hashing with the other symbol-table methods that we have studied to the beginning of SECTION 3.5.

Q&A

Q. How does Java implement `hashCode()` for `Integer`, `Double`, and `Long`?

A. For `Integer` it just returns the 32-bit value. For `Double` and `Long` it returns the *exclusive or* of the first 32 bits with the second 32 bits of the standard machine representation of the number. These choices may not seem to be very random, but they do serve the purpose of spreading out the values.

Q. When using array resizing, the size of the table is always a power of 2. Isn't that a potential problem, because it only uses the least significant bits of `hashCode()`?

A. Yes, particularly with the default implementations. One way to address this problem is to first distribute the key values using a prime larger than M , as in the following example:

```
private int hash(Key x)
{
    int t = x.hashCode() & 0x7fffffff;
    if (lgM < 26) t = t % primes[lgM+5];
    return t % M;
}
```

This code assumes that we maintain an instance variable `lgM` that is equal to $\lg M$ (by initializing to the appropriate value, incrementing when doubling, and decrementing when halving) and an array `primes[]` of the smallest prime greater than each power of 2 (see the table at right). The constant 5 is an arbitrary choice—we expect the first % to distribute the values equally among the values less than the prime and the second to map about five of those values to each value less than M . Note that the point is moot for large M .

k	δ_k	$\text{primes}[k]$ ($2^k - \delta_k$)
5	1	31
6	3	61
7	1	127
8	5	251
9	3	509
10	3	1021
11	9	2039
12	3	4093
13	1	8191
14	3	16381
15	19	32749
16	15	65521
17	1	131071
18	5	262139
19	1	524287
20	3	1048573
21	9	2097143
22	3	4194301
23	15	8388593
24	3	16777213
25	39	33554393
26	5	67108859
27	39	134217689
28	57	268435399
29	3	536870909
30	35	1073741789
31	1	2147483647

Primes for hash table sizes

Q. I've forgotten. Why don't we implement `hash(x)` by returning `x.hashCode() % M`?

A. We need a result between 0 and $M-1$, but in Java, the % function may be negative.

Q. So, why not implement `hash(x)` by returning `Math.abs(x.hashCode()) % M`?

A. Nice try. Unfortunately, `Math.abs()` returns a negative result for the largest negative number. For many typical calculations, this overflow presents no real problem, but for hashing it would leave you with a program that is likely to crash after a few billion inserts, an unsettling possibility. For example, `s.hashCode()` is -2^{31} for the Java `String` value "polygenelubricants". Finding other strings that hash to this value (and to 0) has turned into an amusing algorithm-puzzle pastime.

Q. Why not use `BinarySearchST` or `RedBlackBST` instead of `SequentialSearchST` in ALGORITHM 3.5?

A. Generally, we set parameters so as to make the number of keys hashing to each value small, and elementary symbol tables are generally better for the small tables. In certain situations, slight performance gains may be achieved with such hybrid methods, but such tuning is best left for experts.

Q. Is hashing faster than searching in red-black BSTs?

A. It depends on the type of the key, which determines the cost of computing `hashCode()` versus the cost of `compareTo()`. For typical key types and for Java default implementations, these costs are similar, so hashing will be significantly faster, since it uses only a constant number of operations. But it is important to remember that this question is moot if you need ordered operations, which are not efficiently supported in hash tables. See SECTION 3.5 for further discussion.

Q. Why not let the linear probing table get, say, three-quarters full?

A. No particular reason. You can choose any value of α , using PROPOSITION M to estimate search costs. For $\alpha = 3/4$, the average cost of search hits is 2.5 and search misses is 8.5, but if you let α grow to $7/8$, the average cost of a search miss is 32.5, perhaps more than you want to pay. As α gets close to 1, the estimate in PROPOSITION M becomes invalid, but you don't want your table to get that close to being full.

EXERCISES

3.4.1 Insert the keys E A S Y Q U T I O N in that order into an initially empty table of $M = 5$ lists, using separate chaining. Use the hash function $11 \cdot k \% M$ to transform the k th letter of the alphabet into a table index.

3.4.2 Develop an alternate implementation of `SeparateChainingHashST` that directly uses the linked-list code from `SequentialSearchST`.

3.4.3 Modify your implementation of the previous exercise to include an integer field for each key-value pair that is set to the number of entries in the table at the time that pair is inserted. Then implement a method that deletes all keys (and associated values) for which the field is greater than a given integer k . *Note*: This extra functionality is useful in implementing the symbol table for a compiler.

3.4.4 Write a program to find values of a and M , with M as small as possible, such that the hash function $(a \cdot k) \% M$ for transforming the k th letter of the alphabet into a table index produces distinct values (no collisions) for the keys S E A R C H X M P L. The result is known as a *perfect hash function*.

3.4.5 Is the following implementation of `hashCode()` legal?

```
public int hashCode()
{ return 17; }
```

If so, describe the effect of using it. If not, explain why.

3.4.6 Suppose that keys are t -bit integers. For a modular hash function with prime M , prove that each key bit has the property that there exist two keys differing only in that bit that have different hash values.

3.4.7 Consider the idea of implementing modular hashing for integer keys with the code $(a \cdot k) \% M$, where a is an arbitrary fixed prime. Does this change mix up the bits sufficiently well that you can use nonprime M ?

3.4.8 How many empty lists do you expect to see when you insert N keys into a hash table with `SeparateChainingHashST`, for $N=10, 10^2, 10^3, 10^4, 10^5$, and 10^6 ? *Hint*: See EXERCISE 2.5.31.

3.4.9 Implement an eager `delete()` method for `SeparateChainingHashST`.

3.4.10 Insert the keys E A S Y Q U T I O N in that order into an initially empty table

of size $M = 16$ using linear probing. Use the hash function $11 \cdot k \% M$ to transform the k th letter of the alphabet into a table index. Redo this exercise for $M = 10$.

3.4.11 Give the contents of a linear-probing hash table that results when you insert the keys E A S Y Q U T I O N in that order into an initially empty table of initial size $M = 4$ that is expanded with doubling whenever half full. Use the hash function $11 \cdot k \% M$ to transform the k th letter of the alphabet into a table index.

3.4.12 Suppose that the keys A through G, with the hash values given below, are inserted in some order into an initially empty table of size 7 using a linear-probing table (with no resizing for this problem). Which of the following could not possibly result from inserting these keys?

- a. E F G A C B D
- b. C E B G F D A
- c. B D F A C E G
- d. C G B A D E F
- e. F G B D A C E
- f. G E C A D B F

Give the minimum and the maximum number of probes that could be required to build a table of size 7 with these keys, and an insertion order that justifies your answer.

3.4.13 Which of the following scenarios leads to expected *linear* running time for a random search hit in a linear-probing hash table?

- a. All keys hash to the same index.
- b. All keys hash to different indices.
- c. All keys hash to an even-numbered index.
- d. All keys hash to different even-numbered indices.

3.4.14 Answer the previous question for search *miss*, assuming the search key is equally likely to hash to each table position.

3.4.15 How many compares could it take, in the worst case, to insert N keys into an initially empty table, using linear probing with array resizing?

3.4.16 Suppose that a linear-probing table of size 10^6 is half full, with occupied positions chosen at random. Estimate the probability that all positions with indices divisible

EXERCISES *(continued)*

by 100 are occupied.

3.4.17 Show the result of using the `delete()` method on page 471 to delete C from the table resulting from using `LinearProbingHashST` with our standard indexing client (shown on page 469).

3.4.18 Add a constructor to `SeparateChainingHashST` that gives the client the ability to specify the average number of probes to be tolerated for searches. Use array resizing to keep the average list size less than the specified value, and use the technique described on page 478 to ensure that the modulus for `hash()` is prime.

3.4.19 Implement `keys()` for `SeparateChainingHashST` and `LinearProbingHashST`.

3.4.20 Add a method to `LinearProbingHashST` that computes the average cost of a search hit in the table, assuming that each key in the table is equally likely to be sought.

3.4.21 Add a method to `LinearProbingHashST` that computes the average cost of a search *miss* in the table, assuming a random hash function. *Note:* You do not have to compute any hash functions to solve this problem.

3.4.22 Implement `hashCode()` for various types: `Point2D`, `Interval`, `Interval2D`, and `Date`.

3.4.23 Consider modular hashing for string keys with $R = 256$ and $M = 255$. Show that this is a bad choice because any permutation of letters within a string hashes to the same value.

3.4.24 Analyze the space usage of separate chaining, linear probing, and BSTs for `double` keys. Present your results in a table like the one on page 476.

CREATIVE PROBLEMS

3.4.25 *Hash cache.* Modify `Transaction` on page 462 to maintain an instance variable `hash`, so that `hashCode()` can save the hash value the first time it is called for each object and does not have to recompute it on subsequent calls. *Note:* This idea works only for immutable types.

3.4.26 *Lazy delete for linear probing.* Add to `LinearProbingHashST` a `delete()` method that deletes a key-value pair by setting the value to `null` (but not removing the key) and later removing the pair from the table in `resize()`. Your primary challenge is to decide when to call `resize()`. *Note:* You should overwrite the `null` value if a subsequent `put()` operation associates a new value with the key. Make sure that your program takes into account the number of such *tombstone* items, as well as the number of empty positions, in making the decision whether to expand or contract the table.

3.4.27 *Double probing.* Modify `SeparateChainingHashST` to use a second hash function and pick the shorter of the two lists. Give a trace of the process of inserting the keys E A S Y Q U T I O N in that order into an initially empty table of size $M=3$ using the function $11k \% M$ (for the k th letter) as the first hash function and the function $17k \% M$ (for the k th letter) as the second hash function. Give the average number of probes for random search hit and search miss in this table.

3.4.28 *Double hashing.* Modify `LinearProbingHashST` to use a second hash function to define the probe sequence. Specifically, replace $(i + 1) \% M$ (both occurrences) by $(i + k) \% M$ where k is a nonzero key-dependent integer that is relatively prime to M . *Note:* You may meet the last condition by assuming that M is prime. Give a trace of the process of inserting the keys E A S Y Q U T I O N in that order into an initially empty table of size $M=11$, using the hash functions described in the previous exercise. Give the average number of probes for random search hit and search miss in this table.

3.4.29 *Deletion.* Implement an eager `delete()` method for the methods described in each of the previous two exercises.

3.4.30 *Chi-square statistic.* Add a method to `SeparateChainingST` to compute the χ^2 statistic for the hash table. With N keys and table size M , this number is defined by the equation

$$\chi^2 = (M/N) (f_0 - N/M)^2 + (f_1 - N/M)^2 + \dots (f_{M-1} - N/M)^2)$$

CREATIVE PROBLEMS *(continued)*

where f_i is the number of keys with hash value i . This statistic is one way of checking our assumption that the hash function produces random values. If so, this statistic, for $N > cM$, should be between $M - \sqrt{M}$ and $M + \sqrt{M}$ with probability $1 - 1/c$.

3.4.31 *Cuckoo hashing.* Develop a symbol-table implementation that maintains two hash tables and two hash functions. Any given key is in one of the tables, but not both. When inserting a new key, hash to one of the tables; if the table position is occupied, replace that key with the new key and hash the old key into the other table (again kicking out a key that might reside there). If this process cycles, restart. Keep the tables less than half full. This method uses a constant number of equality tests in the worst case for search (trivial) and amortized constant time for insert.

3.4.32 *Hash attack.* Find 2^N strings, each of length 2^N , that have the same `hashCode()` value, supposing that the `hashCode()` implementation for `String` is the following:

```
public int hashCode()
{
    int hash = 0;
    for (int i = 0; i < length(); i++)
        hash = (hash * 31) + charAt(i);
    return hash;
}
```

Strong hint: Aa and BB have the same value.

3.4.33 *Bad hash function.* Consider the following `hashCode()` implementation for `String`, which was used in early versions of Java:

```
public int hashCode()
{
    int hash = 0;
    int skip = Math.max(1, length()/8);
    for (int i = 0; i < length(); i += skip)
        hash = (hash * 37) + charAt(i);
    return hash;
}
```

Explain why you think the designers chose this implementation and then why you think it was abandoned in favor of the one in the previous exercise.

EXPERIMENTS

3.4.34 *Hash cost.* Determine empirically the ratio of the time required for `hash()` to the time required for `compareTo()`, for as many commonly-used types of keys for which you can get meaningful results.

3.4.35 *Chi-square test.* Use your solution from EXERCISE 3.4.30 to check the assumption that the hash functions for commonly-used key types produce random values.

3.4.36 *List length range.* Write a program that inserts N random `int` keys into a table of size $N/100$ using separate chaining, then finds the length of the shortest and longest lists, for $N = 10^3, 10^4, 10^5, 10^6$.

3.4.37 *Hybrid.* Run experimental studies to determine the effect of using `RedBlackBST` instead of `SequentialSearchST` to handle collisions in `SeparateChainingHashST`. This solution carries the advantage of guaranteeing logarithmic performance even for a bad hash function and the disadvantage of necessitating maintenance of two different symbol-table implementations. What are the practical effects?

3.4.38 *Separate-chaining distribution.* Write a program that inserts 10^5 random non-negative integers less than 10^6 into a table of size 10^5 using linear probing, and that plots the total number of probes used for each 10^3 consecutive insertions. Discuss the extent to which your results validate PROPOSITION K.

3.4.39 *Linear-probing distribution.* Write a program that inserts $N/2$ random `int` keys into a table of size N using linear probing, then computes the average cost of a search miss in the resulting table from the cluster lengths, for $N = 10^3, 10^4, 10^5, 10^6$. Discuss the extent to which your results validate PROPOSITION M.

3.4.40 *Plots.* Instrument `LinearProbingHashST` and `SeparateChainingHashST` to produce plots like the ones shown in the text.

3.4.41 *Double probing.* Run experimental studies to evaluate the effectiveness of double probing (see EXERCISE 3.4.27).

3.4.42 *Double hashing.* Run experimental studies to evaluate the effectiveness of double hashing (see EXERCISE 3.4.28).

3.4.43 *Parking problem.* (D. Knuth) Run experimental studies to validate the hypothesis that the number of compares needed to insert M random keys into a linear-probing table of size M is $\sim cM^{3/2}$, where $c = \sqrt{\pi/2}$.



3.5 APPLICATIONS

FROM THE EARLY DAYS OF COMPUTING, when symbol tables allowed programmers to progress from using numeric addresses in machine language to using symbolic names in assembly language, to modern applications of the new millennium, when symbolic names have meaning across worldwide computer networks, fast search algorithms have played and continue to play an essential role in computation. Modern applications for symbol tables include organization of scientific data, from searching for markers or patterns in genomic data to mapping the universe; organization of knowledge on the web, from searching in online commerce to putting libraries online; and implementing the internet infrastructure, from routing packets among machines on the web to shared file systems and video streaming. Efficient search algorithms have enabled these and countless other important applications. We will consider several representative examples in this section:

- A dictionary client and an indexing client that enable fast and flexible access to information in comma-separated-value files (and similar formats), which are widely used to store data on the web
- An indexing client for building an inverted index of a set of files
- A sparse-matrix data type that uses a symbol table to address problem sizes far beyond what is possible with the standard implementation

In CHAPTER 6, we consider a symbol table that is appropriate for tables such as databases and file systems that contain a vast number of keys, as large as can be reasonably contemplated.

Symbol tables also play a critical role in algorithms that we consider throughout the rest of the book. For example, we use symbol tables to represent graphs (CHAPTER 4) and to process strings (CHAPTER 5).

As we have seen throughout this chapter, developing symbol-table implementations that can guarantee fast performance for all operations is certainly a challenging task. On the other hand, the implementations that we have considered are well-studied, widely used, and available in many software environments (including Java libraries). From this point forward, you certainly should consider the symbol-table abstraction to be a key component in your programmer's toolbox.

Which symbol-table implementation should I use? The table at the bottom of this page summarizes the performance characteristics of the algorithms that we have considered in propositions and properties in this chapter (with the exception of the worst-case results for hashing, which are from the research literature and unlikely to be experienced in practice). It is clear from the table that, for typical applications, your decision comes down to a choice between hash tables and binary search trees.

The advantages of hashing over BST implementations are that the code is simpler and search times are optimal (constant), if the keys are of a standard type or are sufficiently simple that we can be confident of developing an efficient hash function for them that (approximately) satisfies the uniform hashing assumption. The advantages of BSTs over hashing are that they are based on a simpler abstract interface (no hash function need be designed); red-black BSTs can provide guaranteed worst-case performance; and they support a wider range of operations (such as rank, select, sort, and range search). As a rule of thumb, most programmers will use hashing except when one or more of these factors is important, when red-black BSTs are called for. In CHAPTER 5, we will study one exception to this rule of thumb: when keys are long strings, we can build data structures that are even more flexible than red-black BSTs and even faster than hashing.

algorithm (data structure)	worst-case cost (after N inserts)		average-case cost (after N random inserts)		key interface	memory (bytes)
	search	insert	search hit	insert		
<i>sequential search</i> (unordered list)	N	N	$N/2$	N	<code>equals()</code>	$48 N$
<i>binary search</i> (ordered array)	$\lg N$	N	$\lg N$	$N/2$	<code>compareTo()</code>	$16 N$
<i>binary tree search</i> (BST)	N	N	$1.39 \lg N$	$1.39 \lg N$	<code>compareTo()</code>	$64 N$
<i>2-3 tree search</i> (red-black BST)	$2 \lg N$	$2 \lg N$	$1.00 \lg N$	$1.00 \lg N$	<code>compareTo()</code>	$64 N$
<i>separate chaining</i> [†] (array of lists)	$< \lg N$	$< \lg N$	$N/(2M)$	N/M	<code>equals()</code> <code>hashCode()</code>	$48 N + 64 M$
<i>linear probing</i> [†] (parallel arrays)	$c \lg N$	$c \lg N$	< 1.50	< 2.50	<code>equals()</code> <code>hashCode()</code>	between $32 N$ and $128 N$

[†] with uniform and independent hash function

Asymptotic cost summary for symbol-table implementations

Our symbol-table implementations are useful for a wide range of applications, but our algorithms are easily adapted to support several other options that are widely used and worth considering.

Primitive types. Suppose that we have a symbol table with integer keys and associated floating-point numbers. When we use our standard setup, the keys and values are stored as `Integer` and `Double` wrapper-type values, so we need two extra memory references to access each key-value pair. These references may be no problem in an application that involves thousands of searches on thousands of keys but may represent excessive cost in an application that involves billions of searches on millions of keys. Using a primitive type instead of `Key` would save one reference per key-value pair. When the associated value is also primitive, we can eliminate another reference. The situation is diagrammed at right for separate chaining; the same tradeoffs hold for other implementations. For performance-critical applications, it is worthwhile and not difficult to develop versions of our implementations along these lines (see EXERCISE 3.5.4).

Duplicate keys. The possibility of duplicate keys sometimes needs special consideration in symbol-table implementations. In many applications, it is desirable to associate multiple values with the same key. For example, in a transaction-processing system, numerous transactions may have the same customer key value. Our convention to disallow duplicate keys amounts to leaving duplicate-key management to the client. We will consider an example of such a client later in this section. In many of our implementations, we could consider the alternative of leaving key-value pairs with duplicate keys in the primary search data structure and to return *any* value with the given key for a search. We might also add methods to return *all* values with the given key. Our BST and hashing implementations are not difficult to adapt to keep duplicate keys within the data structure; doing so for red-black BSTs is just slightly more challenging (see EXERCISE 3.5.9 and EXERCISE 3.5.10). Such implementations are common in the literature (including earlier editions of this book).

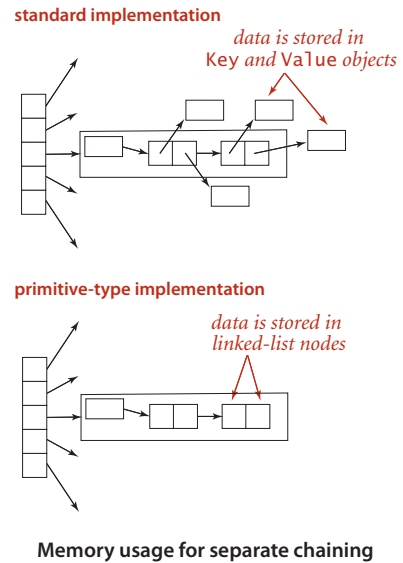

Java libraries. Java’s `java.util.TreeMap` and `java.util.HashMap` libraries are symbol-table implementations based on red-black BSTs and hashing with separate chaining respectively. `TreeMap` does not directly support `rank()`, `select()`, and other operations in our ordered symbol-table API, but it does support operations that enable efficient implementation of these. `HashMap` is roughly equivalent to our `LinearProbingST` implementation—it uses array resizing to enforce a load factor of about 75 percent.

TO BE CONSISTENT AND SPECIFIC, we use in this book the symbol-table implementation based on red-black BSTs from SECTION 3.3 or the one based on linear-probing hashing from SECTION 3.4. For economy and to emphasize client independence from specific implementations, we use the name `ST` as shorthand for `RedBlackBST` for ordered symbol tables in client code and the name `HashST` as shorthand for `LinearProbingHashST` when order is not important and hash functions are available. We adopt these conventions with full knowledge that specific applications might have demands that could call for some variation or extension of one of these algorithms and data structures. Which symbol table should you use? Whatever you decide, test your choice to be sure that it is delivering the performance that you expect.

Set APIs Some symbol-table clients do not need the values, just the ability to insert keys into a table and to test whether a key is in the table. Because we disallow duplicate keys, these operations correspond to the following API where we are just interested in the *set* of keys in the table, not any associated values:

```
public class SET<Key>

---

    SET()                create an empty set
    void add(Key key)    add key into the set
    void delete(Key key) remove key from the set
    boolean contains(Key key) is key in the set?
    boolean isEmpty()    is the set empty?
    int size()           number of keys in the set
    String toString()    string representation of the set
```

API for a basic set data type

You can turn any symbol-table implementation into a `SET` implementation by ignoring values or by using a simple wrapper class (see EXERCISES 3.5.1 through 3.5.3).

Extending SET to include *union*, *intersection*, *complement*, and other common mathematical set operations requires a more sophisticated API (for example, the *complement* operation requires some mechanism for specifying a *universe* of all possible keys) and provides a number of interesting algorithmic challenges, as discussed in EXERCISE 3.5.17.

As with ST, we have unordered and ordered versions of SET. If keys are Comparable, we can include min(), max(), floor(), ceiling(), deleteMin(), deleteMax(), rank(), select(), and the two-argument versions of size() and get() to define a full API for ordered keys. To match our ST conventions, we use the name SET in client code for ordered sets and the name HashSet when order is not important.

To illustrate uses of SET, we consider *filter* clients that read a sequence of strings from standard input and write some of them to standard output. Such clients have their origin in early systems where main memory was far too small to hold all the data, and they are still relevant today, when we write programs that take their input from the web. As example input, we use tinyTale.txt (see page 371). For readability, we preserve newlines from the input to the output in examples, even though the code does not do so.

Dedup. The prototypical filter example is a SET or HashSet client that removes duplicates in the input stream. It is customary to refer to this operation as *dedup*. We maintain a set of the string keys seen so far. If the next key is *in* the set, ignore it; if it is *not in* the set, add it to the set and print it. The keys appear on standard output in the order they appear on standard input, with duplicates removed. This process takes space proportional to the number of distinct keys in the input stream (which is typically far smaller than the total number of keys).

```
public class DeDup
{
    public static void main(String[] args)
    {
        HashSet<String> set;
        set = new HashSet<String>();
        while (!StdIn.isEmpty())
        {
            String key = StdIn.readString();
            if (!set.contains(key))
            {
                set.add(key);
                StdOut.println(key);
            }
        }
    }
}
```

Dedup filter

```
% java DeDup < tinyTale.txt
it was the best of times worst
age wisdom foolishness
epoch belief incredulity
season light darkness
spring hope winter despair
```

Whitelist and blacklist. Another classic filter uses keys in a separate file to decide which keys from the input stream are passed to the output stream. This general process has many natural applications. The simplest example is a *whitelist*, where any key that is in the file is identified as “good.” The client might choose to pass through to standard output any key that is *not in* the whitelist and to ignore any key that is *in* the whitelist (as in the example considered in our first program in CHAPTER 1); another client might choose to pass through to standard output any key that is *in* the whitelist and to ignore any key that is *not in* the whitelist (as shown in the HashSET client `WhiteFilter` at right). For example, your email application might use such a filter to allow you to specify the addresses of your friends and to direct it to consider emails from anyone else as spam. We build a HashSET of the keys in the specified list, then read the keys from standard input. If the next key is *in* the set, print it; if it is *not in* the set, ignore it. A *blacklist* is the opposite, where any key that is in the file is identified as “bad.” Again, there are two natural filters for clients using a blacklist. In our email example, you might specify the addresses of known spammers and direct the email application to let through all mail not from one of those addresses. We can implement a HashSET client `BlackFilter` that implements this filter by negating the filter test in `WhiteFilter`. Typical practical situations such as a credit card company using a blacklist to filter out stolen card numbers or an internet router using a whitelist to implement a firewall are likely to involve huge lists, unbounded input streams, and strict response requirements. The sorts of symbol-table implementations that we have considered enable such challenges to easily be met.

```
public class WhiteFilter
{
    public static void main(String[] args)
    {
        HashSET<String> set;
        set = new HashSET<String>();
        In in = new In(args[0]);
        while (!in.isEmpty())
            set.add(in.readString());
        while (!StdIn.isEmpty())
        {
            String word = StdIn.readString();
            if (set.contains(word))
                StdOut.println(word);
        }
    }
}
```

Whitelist filter

```
% more list.txt
was it the of

% java WhiteFilter list.txt < tinyTale.txt
it was the of it was the of
it was the of it was the of
it was the of it was the of
it was the of it was the of
it was the of it was the of

% java BlackFilter list.txt < tinyTale.txt
best times worst times
age wisdom age foolishness
epoch belief epoch incredulity
season light season darkness
spring hope winter despair
```

Dictionary clients The most basic kind of symbol-table client builds a symbol table with successive *put* operations in order to support *get* requests. Many applications also take advantage of the idea that a symbol table is a *dynamic* dictionary, where it is easy to look up information *and* to update the information in the table. The following list of familiar examples illustrates the utility of this approach:

- *Phone book.* When keys are people’s names and values are their phone numbers, a symbol table models a phone book. A very significant difference from a printed phone book is that we can add new names or change existing phone numbers. We could also use the phone number as the key and the name as the value—if you have never done so, try typing your phone number (with area code) into the search field in your browser.
- *Dictionary.* Associating a word with its definition is a familiar concept that gives us the name “dictionary.” For centuries people kept printed dictionaries in their homes and offices in order to check the definitions and spellings (values) of words (keys). Now, because of good symbol-table implementations, people expect built-in spell checkers and immediate access to word definitions on their computers.
- *Account information.* People who own stock now regularly check the current price on the web. Several services on the web associate a ticker symbol (key) with the current price (value), usually along with a great deal of other information. Commercial applications of this sort abound, including financial institutions associating account information with a name or account number or educational institutions associating grades with a student name or identification number.
- *Genomics.* Symbols play a central role in modern genomics. The simplest example is the use of the letters A, C, T, and G to represent the nucleotides found in the DNA of living organisms. The next simplest is the correspondence between codons (nucleotide triplets) and amino acids (TTA corresponds to leucine, TCT to serine, and so forth), then the correspondence between sequences of amino acids and proteins, and so forth. Researchers in genomics routinely use various types of symbol tables to organize this knowledge.
- *Experimental data.* From astrophysics to zoology, modern scientists are awash in experimental data, and organizing and efficiently accessing this data are vital to understanding what it means. Symbol tables are a critical starting point, and advanced data structures and algorithms that are based on symbol tables are now an important part of scientific research.
- *Compilers.* One of the earliest uses of symbol tables was to organize information for programming. At first, programs were simply sequences of numbers, but programmers very quickly found that using symbolic names for operations and

memory locations (variable names) was far more convenient. Associating the names with the numbers requires a symbol table. As the size of programs grew, the cost of the symbol-table operations became a bottleneck in program development time, which led to the development of data structures and algorithms like the ones we consider in this chapter.

- *File systems.* We use symbol tables regularly to organize data on computer systems. Perhaps the most prominent example is the *file system*, where we associate a file name (key) with the location of its contents (value). Your music player uses the same system to associate song titles (keys) with the location of the music itself (value).
- *Internet DNS.* The domain name system (DNS) that is the basis for organizing information on the internet associates URLs (keys) that humans understand (such as `www.princeton.edu` or `www.wikipedia.org`) with IP addresses (values) that computer network routers understand (such as `208.216.181.15` or `207.142.131.206`). This system is the next-generation “phone book.” Thus, humans can use names that are easy to remember and machines can efficiently process the numbers. The number of symbol-table lookups done each second for this purpose on internet routers around the world is huge, so performance is of obvious importance. Millions of new computers and other devices are put onto the internet each year, so these symbol tables on internet routers need to be dynamic.

Despite its scope, this list is still just a representative sample, intended to give you a flavor of the scope of applicability of the symbol-table abstraction. Whenever you specify something by name, there is a symbol table at work. Your computer’s file system or the web might do the work for you, but there is still a symbol table there somewhere.

As a specific example, we consider a symbol-table client that you can use to look up information that is kept in a table on a file or a web page using the *comma-separated-value* (.csv) file format. This simple format achieves the (admittedly modest) goal of keeping tabular data in a form that anyone can read (and is likely to be able to read in the future) without needing to use a particular application: the data is in text form, one row per line, with entries separated by commas. You can find on the booksite

domain	key	value
<i>phone book</i>	name	phone number
<i>dictionary</i>	word	definition
<i>account</i>	account number	balance
<i>genomics</i>	codon	amino acid
<i>data</i>	data/time	results
<i>compiler</i>	variable name	memory location
<i>file share</i>	song name	machine
	website	IP address

Typical dictionary applications

```

% more amino.csv
TTT,Phe,F,Phenylalanine
TTC,Phe,F,Phenylalanine
TTA,Leu,L,Leucine
TTG,Leu,L,Leucine
TCT,Ser,S,Serine
TCC,Ser,S,Serine
...
GAA,Gly,G,Glutamic Acid
GAG,Gly,G,Glutamic Acid
GGT,Gly,G,Glycine
GGC,Gly,G,Glycine
GGA,Gly,G,Glycine
GGG,Gly,G,Glycine

% more DJIA.csv
...
20-Oct-87,1738.74,608099968,1841.01
19-Oct-87,2164.16,604300032,1738.74
16-Oct-87,2355.09,338500000,2246.73
15-Oct-87,2412.70,263200000,2355.09
...
30-Oct-29,230.98,10730000,258.47
29-Oct-29,252.38,16410000,230.07
28-Oct-29,295.18,9210000,260.64
25-Oct-29,299.47,5920000,301.22
...

% more ip.csv
...
www.ebay.com,66.135.192.87
www.princeton.edu,128.112.128.15
www.cs.princeton.edu,128.112.136.35
www.harvard.edu,128.103.60.24
www.yale.edu,130.132.51.8
www.cnn.com,64.236.16.20
www.google.com,216.239.41.99
www.nytimes.com,199.239.136.200
www.apple.com,17.112.152.32
www.slashdot.org,66.35.250.151
www.espn.com,199.181.135.201
www.weather.com,63.111.66.11
www.yahoo.com,216.109.118.65
...

% more UPC.csv
...
0002058102040,,"1 1/4"" STANDARD STORM DOOR"
0002058102057,,"1 1/4"" STANDARD STORM DOOR"
0002058102125,,"DELUXE STORM DOOR UNIT"
0002082012728,,"100/ per box",,"12 gauge shells"
0002083110812,,"Classical CD",,"Bits and Pieces"
002083142882,CD,"Garth Brooks - Ropin' The Wind"
0002094000003,LB,"PATE PARISIEN"
0002098000009,LB,"PATE TRUFFLE COGNAC-M&H 8Z RW"
0002100001086,,"16 oz",,"Kraft Parmesan"
0002100002090,,"15 pieces",,"Wrigley's Gum"
0002100002434,,"One pint",,"Trader Joe's milk"
...

```

Typical comma-separated-value (.csv) files

numerous .csv files that are related to various applications that we have described, including amino.csv (codon-to-amino-acid encodings), DJIA.csv (opening price, volume, and closing price of the Dow Jones Industrial Average, for every day in its history), ip.csv (a selection of entries from the DNS database), and upc.csv (the Uniform Product Code bar codes that are widely used to identify consumer products). Spreadsheet and other data-processing applications programs can read and write .csv files, and our example illustrates that you can also write a Java program to process the data any way that you would like.

LookupCSV (on the facing page) builds a set of key-value pairs from a file of comma-separated values as specified on the command line and then prints out values corresponding to keys read from standard input. The command-line arguments are the file name and two integers, one specifying the field to serve as the key and the other specifying the field to serve as the value.

The purpose of this example is to illustrate the utility and flexibility of the symbol-table abstraction. What website has IP address 128.112.136.35? (www.cs.princeton.edu) What amino acid corresponds to the codon TCA? (Serine) What was the DJIA on October 29, 1929? (252.38) What product has UPC 0002100001086? (Kraft Parmesan) You can easily look up the answers to questions like these with LookupCSV and the appropriate .csv files.

Performance is not much of an issue when handling interactive queries (since your computer can look through millions

Dictionary lookup

```
public class LookupCSV
{
    public static void main(String[] args)
    {
        In in = new In(args[0]);
        int keyField = Integer.parseInt(args[1]);
        int valField = Integer.parseInt(args[2]);

        ST<String, String> st = new ST<String, String>();

        while (in.hasNextLine())
        {
            String line = in.readLine();
            String[] tokens = line.split(",");
            String key = tokens[keyField];
            String val = tokens[valField];
            st.put(key, val);
        }

        while (!StdIn.isEmpty())
        {
            String query = StdIn.readString();
            if (st.contains(query))
                StdOut.println(st.get(query));
        }
    }
}
```

This data-driven symbol-table client reads key-value pairs from a file, then prints the values corresponding to the keys found on standard input. Both keys and values are strings. The separating delimiter is taken as a command-line argument.

```
% java LookupCSV ip.csv 1 0
128.112.136.35
www.cs.princeton.edu
```

```
% java LookupCSV amino.csv 0 3
TCC
Serine
```

```
% java LookupCSV DJIA.csv 0 3
29-Oct-29
230.07
```

```
% java LookupCSV UPC.csv 0 2
0002100001086
Kraft Parmesan
```

of things in the time it takes to type a query), so fast implementations of ST are not noticeable when you use LookupCSV. However, when a *program* is doing the lookups (and a huge number of them), performance matters. For example, an internet router might need to look up millions of IP addresses per second. In this book, we have already seen the need for good performance with FrequencyCounter, and we will see several other examples in this section.

Examples of similar but more sophisticated test clients for .csv files are described in the exercises. For instance, we could make the dictionary dynamic by also allowing standard-input commands to change the value associated with a key, or we could allow range searching, or we could build multiple dictionaries for the same file.

Indexing clients Dictionaries are characterized by the idea that there is one value associated with each key, so the direct use of our ST data type, which is based on the associative-array abstraction that assigns one value to each key, is appropriate. Each account number uniquely identifies a customer, each UPC uniquely identifies a product, and so forth. In general, of course, there may be multiple values associated with a given key. For example, in our `amino.csv` example, each codon identifies one amino acid, but each amino acid is associated with a list of codons, as in the example `aminoI.csv` at right, where each line contains an amino acid and the list of codons associated with it. We use the term *index* to describe symbol tables that associate multiple values with each key. Here are some more examples:

- *Commercial transactions.* One way for a company that maintains customer accounts to keep track of a day's transactions is to keep an index of the day's transactions. The key is the account number; the value is the list of occurrences of that account number in the transaction list.
- *Web search.* When you type a keyword and get a list of websites containing that keyword, you are using an index created by your web search engine. There is one value (the set of pages) associated with each key (the query), although the reality is a bit more complicated because we often specify multiple keys.

`aminoI.txt`

```

Alanine,AAT,AAC,GCT,GCC,GCA,GCG
Arginine,CGT,CGC,CGA,CGG,AGA,AGG
Aspartic Acid,GAT,GAC
Cysteine,TGT,TGC
Glutamic Acid,GAA,GAG
Glutamine,CAA,CAG
Glycine,GGT,GGC,GGA,GGG
Histidine,CAT,CAC
Isoleucine,ATT,ATC,ATA
Leucine,TTA,TTG,CTT,CTC,CTA,CTG
Lysine,AAA,AAG
Methionine,ATG
Phenylalanine,TTT,TTC
Proline,CCT,CCC,CCA,CCG
Serine,TCT,TCA,TCG,AGT,AGC
Stop,TAA,TAG,TGA
Threonine,ACT,ACC,ACA,ACG
Tyrosine,TAT,TAC
Tryptophan,TGG
Valine,GTT,GTC,GTA,GTG

```

", " separator

key values

A small index file (20 lines)

- *Movies and performers.* The file `movies.txt` on the booksite (excerpted below) is taken from the *Internet Movie Database* (IMDB). Each line has a movie name (the key), followed by a list of performers in that movie (the value), separated by slashes.

We can easily build an index by putting the values to be associated with each key into a single data structure (a Queue, say) and then associating that key with that data structure as value. Extending LookupCSV along these lines is straightforward, but we leave that as an exercise (see EXERCISE 3.5.12) and consider instead LookupIndex on page 499, which uses a symbol table to build an index from files like `aminoI.txt` and `movies.txt` (where the separator character need not be a comma, as in a `.csv` file, but can be specified on the command line). After building the index, LookupIndex then takes key queries and prints the values associated with each key. More interesting, LookupIndex also builds an *inverted index* associated with each file, where values and keys switch roles. In the amino acid example, this gives the same functionality as Lookup (find the amino acid associated with a given codon); in the movie-performer example it adds the ability to find the movies associated with any given performer, which is implicit in the data but would be difficult to produce without a symbol table. *Study this example carefully*, as it provides good insight into the essential nature of symbol tables.

domain	key	value
<i>genomics</i>	amino acid	list of codons
<i>commercial</i>	account number	list of transactions
<i>web search</i>	search key	list of web pages
<i>IMDB</i>	movie	list of performers

Typical indexing applications

```

movies.txt
...
Tin Men (1987)/DeBoy, David/Blumenfeld, Alan/...
Tirez sur le pianiste (1960)/Heymann, Claude/...
Titanic (1997)/Mazin, Stan/...DiCaprio, Leonardo/...
Titus (1999)/Weisskopf, Hermann/Rhys, Matthew/...
To Be or Not to Be (1942)/Verebes, Ernö (I)/...
To Be or Not to Be (1983)/.../Brooks, Mel (I)/...
To Catch a Thief (1955)/Paris, Manuel/...
To Die For (1995)/Smith, Kurtwood/.../Kidman, Nicole/...
...

```

Diagram annotations: An upward arrow labeled "key" points to the first line. A downward arrow labeled "values" points to the list of performers. A red arrow labeled "separator" points to the slash character in the first line.

Small portion of a large index file (250,000+ lines)

Inverted index. The term *inverted index* is normally applied to a situation where values are used to *locate* keys. We have a large amount of data and want to know where certain keys of interest occur. This application is another prototypical example of a symbol-table client that uses an intermixed sequence of calls to `get()` and `put()`. Again, we associate each key with a SET of locations, where the occurrences of the key can be found. The nature and use of the location depend on the application: in a book, a location might be a page number; in a program, a location might be a line number; in genomics, a location might be a position in a genetic sequence; and so forth:

- *Internet Movie DataBase (IMDB)*. In the example just considered, the input is an index that associates each movie with a list of performers. The inverted index associates each performer with a list of movies.
- *Book index*. Every textbook has an index where you look up a term and get the page numbers containing that term. While creating a good index generally involves work by the book author to eliminate common and irrelevant words, a document preparation system will certainly use a symbol table to help automate the process. An interesting special case is known as a *concordance*, which associates each word in a text with the set of positions in the text where that word occurs (see EXERCISE 3.5.20).

domain	key	value
<i>IMDB</i>	performer	set of movies
<i>book</i>	term	set of pages
<i>compiler</i>	identifier	set of places used
<i>file search</i>	search term	set of files
<i>genomics</i>	subsequence	set of locations

Typical inverted indices

- *Compiler*. In a large program that uses a large number of symbols, it is useful to know where each name is used. Historically, an explicit printed symbol table was one of the most important tools used by programmers to keep track of where symbols are used in their programs. In modern systems, symbol tables are the basis of software tools that programmers use to manage names.
- *File search*. Modern operating systems provide you with the ability to type a term and to learn the names of files containing that term. The key is the term; the value is the set of files containing that term.
- *Genomics*. In a typical (if oversimplified) scenario in genomics research, a scientist wants to know the positions of a given genetic sequence in an existing genome or set of genomes. Existence or proximity of certain sequences may be of scientific significance. The starting point for such research is an index like a concordance, but modified to take into account the fact that genomes are not separated into words (see EXERCISE 3.5.15).

Index (and inverted index) lookup

```

public class LookupIndex
{
    public static void main(String[] args)
    {
        In in = new In(args[0]);    // index database
        String sp = args[1];        // separator

        ST<String, Queue<String>> st = new ST<String, Queue<String>>();
        ST<String, Queue<String>> ts = new ST<String, Queue<String>>();

        while (in.hasNextLine())
        {
            String[] a = in.readLine().split(sp);
            String key = a[0];
            for (int i = 1; i < a.length; i++)
            {
                String val = a[i];
                if (!st.contains(key)) st.put(key, new Queue<String>());
                if (!ts.contains(val)) ts.put(val, new Queue<String>());
                st.get(key).enqueue(val);
                ts.get(val).enqueue(key);
            }
        }

        while (!StdIn.isEmpty())
        {
            String query = StdIn.readLine();
            if (st.contains(query))
                for (String s : st.get(query))
                    StdOut.println(" " + s);

            if (ts.contains(query))
                for (String s : ts.get(query))
                    StdOut.println(" " + s);
        }
    }
}

```

This data-driven symbol-table client reads key-value pairs from a file, then prints the values corresponding to the keys found on standard input. Keys are strings; values are lists of strings. The separating delimiter is taken as a command-line argument.

```

% java LookupIndex aminoI.txt ","
Serine
TCT
TCA
TCG
AGT
AGC
TCG
Serine

% java LookupIndex movies.txt "/"
Bacon, Kevin
Mystic River (2003)
Friday the 13th (1980)
Flatliners (1990)
Few Good Men, A (1992)
...
Tin Men (1987)
Blumenfeld, Alan
DeBoy, David
...

```

`FileIndex` (on the facing page) takes file names from the command line and uses a symbol table to build an inverted index associating every word in any of the files with a SET of file names where the word can be found, then takes keyword queries from standard input, and produces its associated list of files. This process is similar to that used by familiar software tools for searching the web or for searching for information on your computer; you type a keyword to get a list of places where that keyword occurs. Developers of such tools typically embellish the process by paying careful attention to

- The form of the query
- The set of files/pages that are indexed
- The order in which files are listed in the response

For example, you are certainly used to typing queries that contain multiple keywords to a web search engine (which is based on indexing a large fraction of the pages on the web) that provides answers in order of relevance or importance (to you or to an advertiser). The exercises at the end of this section address some of these embellishments. We will consider various algorithmic issues related to web search later, but the symbol table is certainly at the heart of the process.

As with `LookupIndex`, you are certainly encouraged to download `FileIndex` from the booksite and use it to index some text files on your computer or some websites of interest, to gain further appreciation for the utility of symbol tables. If you do so, you will find that it can build large indices for huge files with little delay, because each *put* operation and *get* request is taken care of immediately. Providing this immediate response for huge dynamic tables is one of the classic triumphs of algorithmic technology.

File indexing

```
import java.io.File;
public class FileIndex
{
    public static void main(String[] args)
    {
        ST<String, SET<File>> st = new ST<String, SET<File>>();
        for (String filename : args)
        {
            File file = new File(filename);
            In in = new In(file);
            while (!in.isEmpty())
            {
                String word = in.readString();
                if (!st.contains(word)) st.put(word, new SET<File>());
                SET<File> set = st.get(word);
                set.add(file);
            }
        }
        while (!StdIn.isEmpty())
        {
            String query = StdIn.readString();
            if (st.contains(query))
                for (File file : st.get(query))
                    StdOut.println(" " + file.getName());
        }
    }
}
```

This symbol-table client indexes a set of files. We search for each word in each file in a symbol table, maintaining a SET of file names that contain the word. Names for In can also refer to web pages, so this code can also be used to build an inverted index of web pages.

```
% more ex1.txt
it was the best of times

% more ex2.txt
it was the worst of times

% more ex3.txt
it was the age of wisdom

% more ex4.txt
it was the age of foolishness
```

```
% java FileIndex ex*.txt
age
    ex3.txt
    ex4.txt
best
    ex1.txt
was
    ex1.txt
    ex2.txt
    ex3.txt
    ex4.txt
```

Sparse vectors Our next example illustrates the importance of symbol tables in scientific and mathematical calculations. We describe a fundamental and familiar calculation that becomes a bottleneck in typical practical applications, then show how using a symbol table can remove the bottleneck and enable solution of vastly larger problems. Indeed, this particular calculation was at the core of the PageRank algorithm that was developed by S. Brin and L. Page and led to the emergence of Google in the early 2000s (and is a well-known mathematical abstraction that is useful in many other contexts).

$$\begin{array}{c}
 \mathbf{a}[][] \\
 \begin{bmatrix} 0 & .90 & 0 & 0 & 0 \\ 0 & 0 & .36 & .36 & .18 \\ 0 & 0 & 0 & .90 & 0 \\ .90 & 0 & 0 & 0 & 0 \\ .47 & 0 & .47 & 0 & 0 \end{bmatrix}
 \end{array}
 \begin{array}{c}
 \mathbf{x}[] \\
 \begin{bmatrix} .05 \\ .04 \\ .36 \\ .37 \\ .19 \end{bmatrix}
 \end{array}
 =
 \begin{array}{c}
 \mathbf{b}[] \\
 \begin{bmatrix} .036 \\ .297 \\ .333 \\ .045 \\ .1927 \end{bmatrix}
 \end{array}$$

Matrix-vector multiplication

The basic calculation that we consider is *matrix-vector multiplication*: given a matrix and a vector, compute a result vector whose i th entry is the *dot product* of the given vector and the i th row of the matrix. For simplicity, we consider the case when the matrix is square with N rows and N columns and the vectors are of size N . This operation is elementary to code in Java, requiring time proportional to N^2 , for the N multiplications to compute each of the N entries in the

result vector, which also matches the space proportional to N^2 that is required to store the matrix.

In practice, it is very often the case that N is huge. For example, in the Google application cited above, N is the number of pages on the web. At the time PageRank was developed, that was in the tens or hundreds of billions and it has skyrocketed since, so the value of N^2 would be far more than 10^{20} . No one can afford that much time or space, so a better algorithm is needed.

Fortunately, it is also often the case that the matrix is *sparse*: a huge number of its entries are 0. Indeed, for the Google application, the average number of nonzero entries per row is a small constant: virtually all web pages have links to only a few others (not all the pages on the web). Accordingly, we can represent the matrix as an array of sparse vectors, using a `SparseVector` implementation like the `HashST` client on the facing page. Instead of using the

```

...
double[][] a = new double[N][N];
double[] x = new double[N];
double[] b = new double[N];
...
// Initialize a[][] and x[]
...
for (int i = 0; i < N; i++)
{
    sum = 0.0;
    for (int j = 0; j < N; j++)
        sum += a[i][j]*x[j];
    b[i] = sum;
}

```

Standard implementation of matrix-vector multiplication

Sparse vector with dot product

```
public class SparseVector
{
    private HashST<Integer, Double> st;
    public SparseVector()
    { st = new HashST<Integer, Double>(); }
    public int size()
    { return st.size(); }
    public void put(int i, double x)
    { st.put(i, x); }
    public double get(int i)
    {
        if (!st.contains(i)) return 0.0;
        else return st.get(i);
    }
    public double dot(double[] that)
    {
        double sum = 0.0;
        for (int i : st.keys())
            sum += that[i]*this.get(i);
        return sum;
    }
}
```

This symbol-table client is a bare-bones sparse vector implementation that illustrates an efficient dot product for sparse vectors. We multiply each entry by its counterpart in the other operand and add the result to a running sum. The number of multiplications required is equal to the number of nonzero entries in the sparse vector.

array of double[] objects

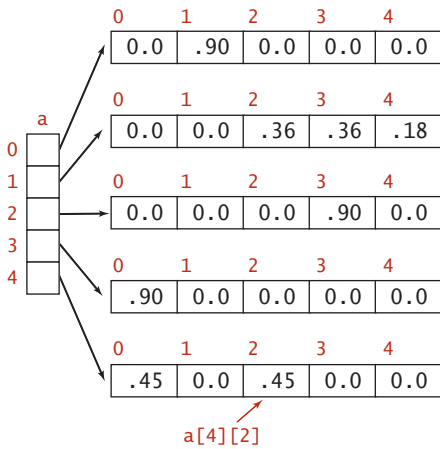

array of SparseVector objects

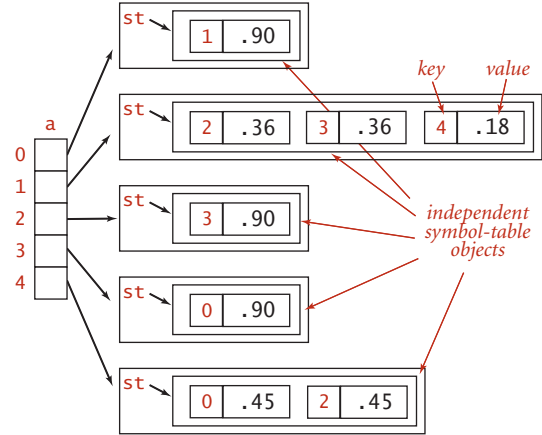

Sparse matrix representations

code `a[i][j]` to refer to the element in row `i` and column `j`, we use `a[i].put(j, val)` to set a value in the matrix and `a[i].get(j)` to retrieve a value. As you can see from the code below, matrix-vector multiplication using this class is even simpler than with the array representation (and it more clearly describes the computation). More important, it only requires time proportional to N plus the number of nonzero elements in the matrix.

For small matrices or matrices that are not sparse, the overhead for maintaining symbol tables can be substantial, but it is worth your while to be sure to understand the ramifications of using symbol tables for huge sparse matrices. To fix ideas, consider a huge application (like the one faced by Brin and Page) where N is 10 billion or 100 billion, but the average number of nonzero elements per row is less than 10. For such an application, *using symbol tables speeds up matrix-vector multiplication by a factor of a billion or more*. The elementary nature of this application should not detract from its importance: programmers who do not take advantage of the potential to save time and space in this way severely limit their potential to solve practical problems, while programmers who do take factor-

```

..
SparseVector[] a;
a = new SparseVector[N];
double[] x = new double[N];
double[] b = new double[N];
...
// Initialize a[] and x[].
...
for (int i = 0; i < N; i++)
    b[i] = a[i].dot(x);

```

Sparse matrix-vector multiplication

of-a-billion speedups when they are available are likely to be able to address problems that could not otherwise be contemplated.

Building the matrix for the Google application is a graph-processing application (and a symbol-table client!), albeit for a huge sparse matrix. Given the matrix, the Page-Rank calculation is nothing more than doing a matrix-vector multiplication, replacing the source vector with the result vector, and iterating the process until it converges (as guaranteed by fundamental theorems in probability theory). Thus, the use of a class like `SparseVector` can improve the time and space usage for this application by a factor of 10 billion or 100 billion or more.

Similar savings are possible in many scientific calculations, so sparse vectors and matrices are widely used and typically incorporated into specialized systems for scientific computing. When working with huge vectors and matrices, it is wise to run simple performance tests to be sure that the kinds of performance gains that we have illustrated here are not being missed. On the other hand, array processing for primitive types of data is built in to most programming languages, so using arrays for vectors that are not sparse, as we did in this example, may offer further speedups. Developing a good understanding of the underlying costs and making the appropriate implementation decisions is certainly worthwhile for such applications.

SYMBOL TABLES ARE A PRIMARY CONTRIBUTION OF ALGORITHMIC TECHNOLOGY to the development of our modern computational infrastructure because of their ability to deliver savings on a huge scale in a vast array of practical applications, making the difference between providing solutions to a wide range of problems and not being able to address them at all. Few fields of science or engineering involve studying the effects of an invention that improves costs by factors of 100 billion—symbol-table applications put us in just that position, as we have just seen in several examples, and these improvements have had profound effects. The data structures and algorithms that we have considered are certainly not the final word: they were all developed in just a few decades, and their properties are not fully understood. Because of their importance, symbol-table implementations continue to be studied intensely by researchers around the world, and we can look forward to new developments on many fronts as the scale and scope of the applications they address continue to expand.

Q&A

Q. Can a SET contain null?

A. No. As with symbol tables, keys are non-null objects.

Q. Can a SET be null?

A. No. A SET can be empty (contain no objects), but not null. As with any Java data type, a variable of type SET can have the value null, but that just indicates that it does not reference any SET. The result of using new to create a SET is always an object that is not null.

Q. If all my data is in memory, there is no real reason to use a filter, right?

A. Right. Filtering really shines in the case when you have no idea how much data to expect. Otherwise, it may be a useful way of thinking, but not a cure-all.

Q. I have data in a spreadsheet. Can I develop something like LookupCSV to search through it?

A. Your spreadsheet application probably has an option to export to a .csv file, so you can use LookupCSV directly.

Q. Why would I need FileIndex? Doesn't my operating system solve this problem?

A. If you are using an OS that meets your needs, continue to do so, by all means. As with many of our programs, FileIndex is intended to show you the basic underlying mechanisms of such applications and to suggest possibilities to you.

Q. Why not have the dot() method in SparseVector take a SparseVector object as argument and return a SparseVector object?

A. That is a fine alternate design and a nice programming exercise that requires code that is a bit more intricate than for our design (see EXERCISE 3.5.16). For general matrix processing, it might be worthwhile to also add a SparseMatrix type.

EXERCISES

- 3.5.1** Implement SET and HashSET as “wrapper class” clients of ST and HashST, respectively (provide dummy values and ignore them).
- 3.5.2** Develop a SET implementation `SequentialSearchSET` by starting with the code for `SequentialSearchST` and eliminating all of the code involving values.
- 3.5.3** Develop a SET implementation `BinarySearchSET` by starting with the code for `BinarySearchST` and eliminating all of the code involving values.
- 3.5.4** Develop classes `HashSTint` and `HashSTdouble` for maintaining sets of keys of primitive `int` and `double` types, respectively. (Convert generics to primitive types in the code of `LinearProbingHashST`.)
- 3.5.5** Develop classes `STint` and `STdouble` for maintaining ordered symbol tables where keys are primitive `int` and `double` types, respectively. (Convert generics to primitive types in the code of `RedBlackBST`.) Test your solution with a version of `SparseVector` as a client.
- 3.5.6** Develop classes `HashSETint` and `HashSETdouble` for maintaining sets of keys of primitive `int` and `double` types, respectively. (Eliminate code involving values in your solution to EXERCISE 3.5.4.)
- 3.5.7** Develop classes `SETint` and `SETdouble` for maintaining ordered sets of keys of primitive `int` and `double` types, respectively. (Eliminate code involving values in your solution to EXERCISE 3.5.5.)
- 3.5.8** Modify `LinearProbingHashST` to keep duplicate keys in the table. Return *any* value associated with the given key for `get()`, and remove *all* items in the table that have keys equal to the given key for `delete()`.
- 3.5.9** Modify `BST` to keep duplicate keys in the tree. Return *any* value associated with the given key for `get()`, and remove *all* nodes in the tree that have keys equal to the given key for `delete()`.
- 3.5.10** Modify `RedBlackBST` to keep duplicate keys in the tree. Return *any* value associated with the given key for `get()`, and remove *all* nodes in the tree that have keys equal to the given key for `delete()`.

EXERCISES *(continued)*

- 3.5.11** Develop a `MultiSET` class that is like `SET`, but allows equal keys and thus implements a mathematical *multiset*.
- 3.5.12** Modify `LookupCSV` to associate with each key all values that appear in a key-value pair with that key in the input (not just the most recent, as in the associative-array abstraction).
- 3.5.13** Modify `LookupCSV` to make a program `RangeLookupCSV` that takes two key values from the standard input and prints all key-value pairs in the `.csv` file such that the key falls within the range specified.
- 3.5.14** Develop and test a static method `invert()` that takes as argument an `ST<String, Bag<String>>` and produces as return value the inverse of the given symbol table (a symbol table of the same type).
- 3.5.15** Write a program that takes a string on standard input and an integer k as command-line argument and puts on standard output a sorted list of the k -grams found in the string, each followed by its index in the string.
- 3.5.16** Add a method `sum()` to `SparseVector` that takes a `SparseVector` as argument and returns a `SparseVector` that is the term-by-term sum of this vector and the argument vector. *Note:* You need `delete()` (and special attention to precision) to handle the case where an entry becomes 0.

CREATIVE PROBLEMS

3.5.17 *Mathematical sets.* Your goal is to develop an implementation of the following API `MathSET` for processing (mutable) mathematical sets:

```
public class MathSET<Key>
    MathSET(Key[] universe)           create a set
    void add(Key key)                 put key into the set
    MathSET<Key> complement()         set of keys in the universe that
                                     are not in this set
    void union(MathSET<Key> a)        put any keys from a into the
                                     set that are not already there
    void intersection(MathSET<Key> a) remove any keys from this set
                                     that are not in a
    void delete(Key key)              remove key from the set
    boolean contains(Key key)         is key in the set?
    boolean isEmpty()                 is the set empty?
    int size()                        number of keys in the set
```

API for a basic set data type

Use a symbol table. *Extra credit:* Represent sets with arrays of `boolean` values.

3.5.18 *Multisets.* After referring to EXERCISES 3.5.2 and 3.5.3 and the previous exercise, develop APIs `MultiHashSet` and `MultiSET` for multisets (sets that can have equal keys) and implementations `SeparateChainingMultiSET` and `BinarySearchMultiSET` for multisets and ordered multisets, respectively.

3.5.19 *Equal keys in symbol tables.* Consider the API `MultiST` (unordered or ordered) to be the same as our symbol-table APIs defined on page 363 and page 366, but with equal keys allowed, so that the semantics of `get()` is to return *any* value associated with the given key, and we add a new method

```
Iterable<Value> getAll(Key key)
```

CREATIVE PROBLEMS *(continued)*

that returns *all* values associated with the given key. Using our code for `SeparateChainingST` and `BinarySearchST` as a starting point, develop implementations `SeparateChainingMultiST` and `BinarySearchMultiST` for these APIs.

3.5.20 *Concordance.* Write an ST client `Concordance` that puts on standard output a concordance of the strings in the standard input stream (see page 498).

3.5.21 *Inverted concordance.* Write a program `InvertedConcordance` that takes a concordance on standard input and puts the original string on standard output stream. *Note:* This computation is associated with a famous story having to do with the Dead Sea Scrolls. The team that discovered the original tablets enforced a secrecy rule that essentially resulted in their making public only a concordance. After a while, other researchers figured out how to invert the concordance, and the full text was eventually made public.

3.5.22 *Fully indexed CSV.* Implement an ST client `FullLookupCSV` that builds an array of ST objects (one for each field), with a test client that allows the user to specify the key and value fields in each query.

3.5.23 *Sparse matrices.* Develop an API and an implementation for sparse 2D matrices. Support matrix addition and matrix multiplication. Include constructors for row and column vectors.

3.5.24 *Non-overlapping interval search.* Given a list of non-overlapping intervals of items, write a function that takes an item as argument and determines in which, if any, interval that item lies. For example, if the items are integers and the intervals are 1643–2033, 5532–7643, 8999–10332, 5666653–5669321, then the query point 9122 lies in the third interval and 8122 lies in no interval.

3.5.25 *Registrar scheduling.* The registrar at a prominent northeastern University recently scheduled an instructor to teach two different classes at the same exact time. Help the registrar prevent future mistakes by describing a method to check for such conflicts. For simplicity, assume all classes run for 50 minutes starting at 9:00, 10:00, 11:00, 1:00, 2:00, or 3:00.

3.5.26 *LRU cache.* Create a data structure that supports the following operations: access and remove. The access operation inserts the item onto the data structure if it's not already present. The remove operation deletes and returns the item that was least

recently accessed. *Hint*: Maintain the items in order of access in a doubly linked list, along with pointers to the first and last nodes. Use a symbol table with keys = items, values = location in linked list. When you access an element, delete it from the linked list and reinsert it at the beginning. When you remove an element, delete it from the end and remove it from the symbol table.

3.5.27 *List*. Develop an implementation of the following API:

```
public class List<Item> implements Iterable<Item>
```

List()	<i>create a list</i>
void addFront(Item item)	<i>add item to the front</i>
void addBack(Item item)	<i>add item to the back</i>
Item deleteFront()	<i>remove from the front</i>
Item deleteBack()	<i>remove from the back</i>
void delete(Item item)	<i>remove item from the list</i>
void add(int i, Item item)	<i>add item as the ith in the list</i>
Item delete(int i)	<i>remove the ith item from the list</i>
boolean contains(Item item)	<i>is key in the list?</i>
boolean isEmpty()	<i>is the list empty?</i>
int size()	<i>number of items in the list</i>

API for a list data type

Hint: Use two symbol tables, one to find the *i*th item in the list efficiently, and the other to efficiently search by item. (Java's `java.util.List` interface contains methods like these but does not supply any implementation that efficiently supports all operations.)

3.5.28 *UniQueue*. Create a data type that is a queue, except that an element may only be inserted the queue once. Use an existence symbol table to keep track of all elements that have ever been inserted and ignore requests to re-insert such items.

CREATIVE PROBLEMS *(continued)*

3.5.29 *Symbol table with random access.* Create a data type that supports inserting a key-value pair, searching for a key and returning the associated value, and deleting and returning a random key. *Hint:* Combine a symbol table and a randomized queue.

EXPERIMENTS

3.5.30 *Duplicates (revisited)*. Redo EXERCISE 2.5.31 using the `Dedup` filter given on page 490. Compare the running times of the two approaches. Then use `Dedup` to run the experiments for $N = 10^7$, 10^8 , and 10^9 , repeat the experiments for random long values and discuss the results.

3.5.31 *Spell checker*. With the file `dictionary.txt` from the booksite as command-line argument, the `BlackFilter` client described on page 491 prints all misspelled words in a text file taken from standard input. Compare the performance of `RedBlackBST`, `SeparateChainingHashST`, and `LinearProbingHashST` for the file `WarAndPeace.txt` (available on the booksite) with this client and discuss the results.

3.5.32 *Dictionary*. Study the performance of a client like `LookupCSV` in a scenario where performance matters. Specifically, design a query-generation scenario instead of taking commands from standard input, and run performance tests for large inputs and large numbers of queries.

3.5.33 *Indexing*. Study a client like `LookupIndex` in a scenario where performance matters. Specifically, design a query-generation scenario instead of taking commands from standard input, and run performance tests for large inputs and large numbers of queries.

3.5.34 *Sparse vector*. Run experiments to compare the performance of matrix-vector multiplication using `SparseVector` to the standard implementation using arrays.

3.5.35 *Primitive types*. Evaluate the utility of using primitive types for `Integer` and `Double` values, for `LinearProbingHashST` and `RedBlackBST`. How much space and time are saved, for large numbers of searches in large tables?

FOUR

Graphs

4.1	Undirected Graphs	518
4.2	Directed Graphs	566
4.3	Minimum Spanning Trees	604
4.4	Shortest Paths	638

Pairwise connections between items play a critical role in a vast array of computational applications. The relationships implied by these connections lead immediately to a host of natural questions: Is there a way to connect one item to another by following the connections? How many other items are connected to a given item? What is the shortest chain of connections between this item and this other item?

To model such situations, we use abstract mathematical objects called *graphs*. In this chapter, we examine basic properties of graphs in detail, setting the stage for us to study a variety of algorithms that are useful for answering questions of the type just posed. These algorithms serve as the basis for attacking problems in important applications whose solution we could not even contemplate without good algorithmic technology.

Graph theory, a major branch of mathematics, has been studied intensively for hundreds of years. Many important and useful properties of graphs have been discovered, many important algorithms have been developed, and many difficult problems are still actively being studied. In this chapter, we introduce a variety of fundamental graph algorithms that are important in diverse applications.

Like so many of the other problem domains that we have studied, the algorithmic investigation of graphs is relatively recent. Although a few of the fundamental algorithms are centuries old, the majority of the interesting ones have been discovered within the last several decades and have benefited from the emergence of the algorithmic technology that we have been studying. Even the simplest graph algorithms lead to useful computer programs, and the nontrivial algorithms that we examine are among the most elegant and interesting algorithms known.

To illustrate the diversity of applications that involve graph processing, we begin our exploration of algorithms in this fertile area by introducing several examples.

Maps. A person who is planning a trip may need to answer questions such as “What is the shortest route from Providence to Princeton?” A seasoned traveler who has experienced traffic delays on the shortest route may ask the question “What is the fastest way to get from Providence to Princeton?” To answer such questions, we process information about connections (roads) between items (intersections).

Web content. When we browse the web, we encounter pages that contain references (links) to other pages and we move from page to page by clicking on the links. The entire web is a graph, where the items are pages and the connections are links. Graph-processing algorithms are essential components of the search engines that help us locate information on the web.

Circuits. An electric circuit comprises devices such as transistors, resistors, and capacitors that are intricately wired together. We use computers to control machines that make circuits and to check that the circuits perform desired functions. We need to answer simple questions such as “Is a short-circuit present?” as well as complicated questions such as “Can we lay out this circuit on a chip without making any wires cross?” The answer to the first question depends on only the properties of the connections (wires), whereas the answer to the second question requires detailed information about the wires, the devices that those wires connect, and the physical constraints of the chip.

Schedules. A manufacturing process requires a variety of jobs to be performed, under a set of constraints that specify that certain tasks cannot be started until certain other tasks have been completed. How do we schedule the tasks such that we both respect the given constraints and complete the whole process in the least amount of time?

Commerce. Retailers and financial institutions track buy/sell orders in a market. A connection in this situation represents the transfer of cash and goods between an institution and a customer. Knowledge of the nature of the connection structure in this instance may enhance our understanding of the nature of the market.

Matching. Students apply for positions in selective institutions such as social clubs, universities, or medical schools. Items correspond to the students and the institutions; connections correspond to the applications. We want to discover methods for matching interested students with available positions.

Computer networks. A computer network consists of interconnected sites that send, forward, and receive messages of various types. We are interested in knowing about the nature of the interconnection structure because we want to lay wires and build switches that can handle the traffic efficiently.

Software. A compiler builds graphs to represent relationships among modules in a large software system. The items are the various classes or modules that comprise the system; connections are associated either with the possibility that a method in one class might call another (static analysis) or with actual calls while the system is in operation (dynamic analysis). We need to analyze the graph to determine how best to allocate resources to the program most efficiently.

Social networks. When you use a social network, you build explicit connections with your friends. Items correspond to people; connections are to friends or followers. Understanding the properties of these networks is a modern graph-processing application of intense interest not just to companies that support such networks, but also in politics, diplomacy, entertainment, education, marketing, and many other domains.

THESE EXAMPLES INDICATE THE RANGE OF APPLICATIONS for which graphs are the appropriate abstraction and also the range of computational problems that we might encounter when we work with graphs. Thousands of such problems have been studied, but many problems can be addressed in the context of one of several basic graph models—we will study the most important ones in this chapter. In practical applications, it is common for the volume of data involved to be truly huge, so that efficient algorithms make the difference between whether or not a solution is at all feasible.

To organize the presentation, we progress through the four most important types of graph models: *undirected graphs* (with simple connections), *digraphs* (where the direction of each connection is significant), *edge-weighted graphs* (where each connection has an associated weight), and *edge-weighted digraphs* (where each connection has both a direction and a weight).

application	item	connection
<i>map</i>	intersection	road
<i>web content</i>	page	link
<i>circuit</i>	device	wire
<i>schedule</i>	job	constraint
<i>commerce</i>	customer	transaction
<i>matching</i>	student	application
<i>computer network</i>	site	connection
<i>software</i>	method	call
<i>social network</i>	person	friendship

Typical graph applications

4.1 UNDIRECTED GRAPHS

OUR STARTING POINT is the study of graph models where *edges* are nothing more than connections between *vertices*. We use the term *undirected graph* in contexts where we need to distinguish this model from other models (such as the title of this section), but, since this is the simplest model, we start with the following definition:

Definition. A *graph* is a set of *vertices* and a collection of *edges* that each connect a pair of vertices.

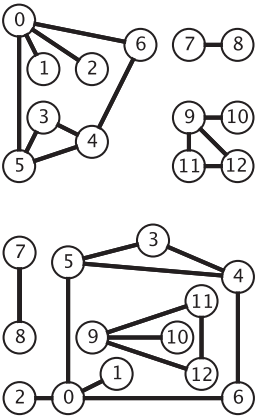

Two drawings of the same graph

Vertex names are not important to the definition, but we need a way to refer to vertices. By convention, we use the names 0 through $V-1$ for the vertices in a V -vertex graph. The main reason that we choose this system is to make it easy to write code that efficiently accesses information corresponding to each vertex, using array indexing. It is not difficult to use a symbol table to establish a 1-1 mapping to associate V arbitrary vertex names with the V integers between 0 and $V-1$ (see page 548), so the convenience of using indices as vertex names comes without loss of generality (and without much loss of efficiency). We use the notation $v-w$ to refer to an edge that connects v and w ; the notation $w-v$ is an alternate way to refer to the same edge.

We draw a graph with circles for the vertices and lines connecting them for the edges. A drawing gives us intuition about the structure of the graph; but this intuition can be misleading, because the graph is defined independently of the drawing. For example, the two drawings at left represent the same graph, because the graph is nothing more than its (unordered) set of vertices and its (unordered) collection of edges (vertex pairs).

Anomalies. Our definition allows two simple anomalies:

- A *self-loop* is an edge that connects a vertex to itself.
- Two edges that connect the same pair of vertices are *parallel*.

Mathematicians sometimes refer to graphs with parallel edges as *multigraphs* and graphs with no parallel edges or self-loops as *simple graphs*. Typically, our implementations allow self-loops and parallel edges (because they arise in applications), but we do not include them in examples. Thus, we can refer to every edge just by naming the two vertices it connects.

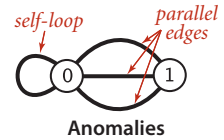

Glossary A substantial amount of nomenclature is associated with graphs. Most of the terms have straightforward definitions, and, for reference, we consider them in one place: here.

When there is an edge connecting two vertices, we say that the vertices are *adjacent* to one another and that the edge is *incident* to both vertices. The *degree* of a vertex is the number of edges incident to it. A *subgraph* is a subset of a graph's edges (and associated vertices) that constitutes a graph. Many computational tasks involve identifying subgraphs of various types. Of particular interest are edges that take us through a *sequence* of vertices in a graph.

Definition. A *path* in a graph is a sequence of vertices connected by edges. A *simple path* is one with no repeated vertices. A *cycle* is a path with at least one edge whose first and last vertices are the same. A *simple cycle* is a cycle with no repeated edges or vertices (except the requisite repetition of the first and last vertices). The *length* of a path or a cycle is its number of edges.

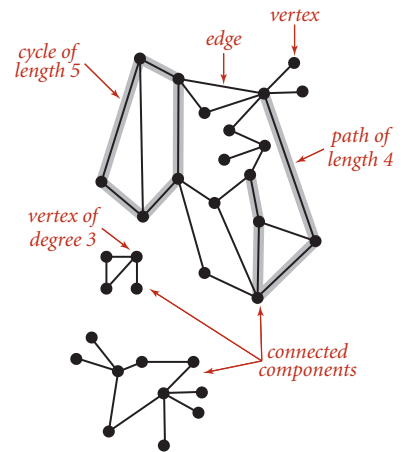

Anatomy of a graph

Most often, we work with simple cycles and simple paths and drop the *simple* modifier; when we want to allow repeated vertices, we refer to *general* paths and cycles. We say that one vertex is *connected* to another if there exists a path that contains both of them. We use notation like $u-v-w-x$ to represent a path from u to x and $u-v-w-x-u$ to represent a cycle from u to v to w to x and back to u again. Several of the algorithms that we consider find paths and cycles. Moreover, paths and cycles lead us to consider the structural properties of a graph as a whole:

Definition. A graph is *connected* if there is a path from every vertex to every other vertex in the graph. A graph that is *not connected* consists of a set of *connected components*, which are maximal connected subgraphs.

Intuitively, if the vertices were physical objects, such as knots or beads, and the edges were physical connections, such as strings or wires, a connected graph would stay in one piece if picked up by any vertex, and a graph that is not connected comprises two or more such pieces. Generally, processing a graph necessitates processing the connected components one at a time.

An *acyclic* graph is a graph with no cycles. Several of the algorithms that we consider are concerned with finding acyclic subgraphs of a given graph that satisfy certain properties. We need additional terminology to refer to these structures:

Definition. A *tree* is an acyclic connected graph. A disjoint set of trees is called a *forest*. A *spanning tree* of a connected graph is a subgraph that contains all of that graph's vertices and is a single tree. A *spanning forest* of a graph is the union of spanning trees of its connected components.

This definition of tree is quite general: with suitable refinements it embraces the trees that we typically use to model program behavior (function-call hierarchies) and data structures (BSTs, 2-3 trees, and so forth). Mathematical properties of trees are well-studied and intuitive, so we state them without proof. For example, a graph G with V vertices is a tree if and only if it satisfies any of the following five conditions:

- G has $V-1$ edges and no cycles.
- G has $V-1$ edges and is connected.
- G is connected, but removing any edge disconnects it.
- G is acyclic, but adding any edge creates a cycle.
- Exactly one simple path connects each pair of vertices in G .

Several of the algorithms that we consider find spanning trees and forests, and these properties play an important role in their analysis and implementation.

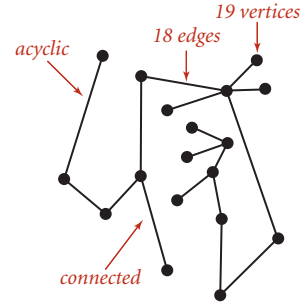

A tree

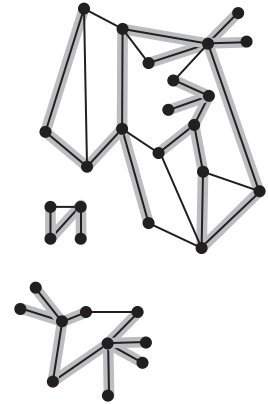

A spanning forest

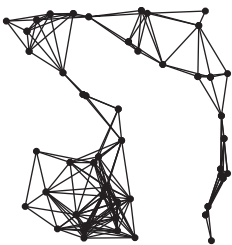
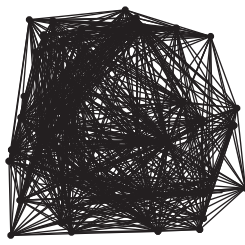
sparse ($E = 200$)dense ($E = 1000$)Two graphs ($V = 50$)

The *density* of a graph is the proportion of possible pairs of vertices that are connected by edges. A *sparse* graph has relatively few of the possible edges present; a *dense* graph has relatively few of the possible edges missing. Generally, we think of a graph as being sparse if its number of different edges is within a small constant factor of V and as being dense otherwise. This rule of thumb

leaves a gray area (when the number of edges is, say, $\sim cV^{3/2}$) but the distinction between sparse and dense is typically very clear in applications. The applications that we consider nearly always involve sparse graphs.

A *bipartite graph* is a graph whose vertices we can divide into two sets such that all edges connect a vertex in one set with a vertex in the other set. The figure at right gives an example of a bipartite graph, where one set of vertices is colored red and the other set of vertices is colored black. Bipartite graphs arise in a natural way in many situations, one of which we will consider in detail at the end of this section.

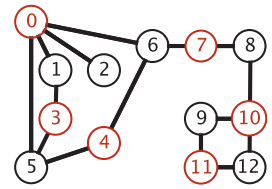

A bipartite graph

WITH THESE PREPARATIONS, we are ready to move on to consider graph-processing algorithms. We begin by considering an API and implementation for a graph data type, then we consider classic algorithms for searching graphs and for identifying connected components. To conclude the section, we consider real-world applications where vertex names need not be integers and graphs may have huge numbers of vertices and edges.

Undirected graph data type Our starting point for developing graph-processing algorithms is an API that defines the fundamental graph operations. This scheme allows us to address graph-processing tasks ranging from elementary maintenance operations to sophisticated solutions of difficult problems.

```
public class Graph
    Graph(int V)           create a V-vertex graph with no edges
    Graph(In in)          read a graph from input stream in
    int V()               number of vertices
    int E()               number of edges
    void addEdge(int v, int w) add edge v-w to this graph
    Iterable<Integer> adj(int v) vertices adjacent to v
    String toString()     string representation
```

API for an undirected graph

This API contains two constructors, methods to return the number of vertices and edges, a method to add an edge, a `toString()` method, and a method `adj()` that allows client code to iterate through the vertices adjacent to a given vertex (the order of iteration is not specified). Remarkably, we can build all of the algorithms that we consider in this section on the basic abstraction embodied in `adj()`.

The second constructor assumes an input format consisting of $2E+2$ integer values: V , then E , then E pairs of values between 0 and $V-1$, each pair denoting an edge. As examples, we use the two graphs `tinyG.txt` and `mediumG.txt` that are depicted below.

Several examples of `Graph` client code are shown in the table on the facing page.

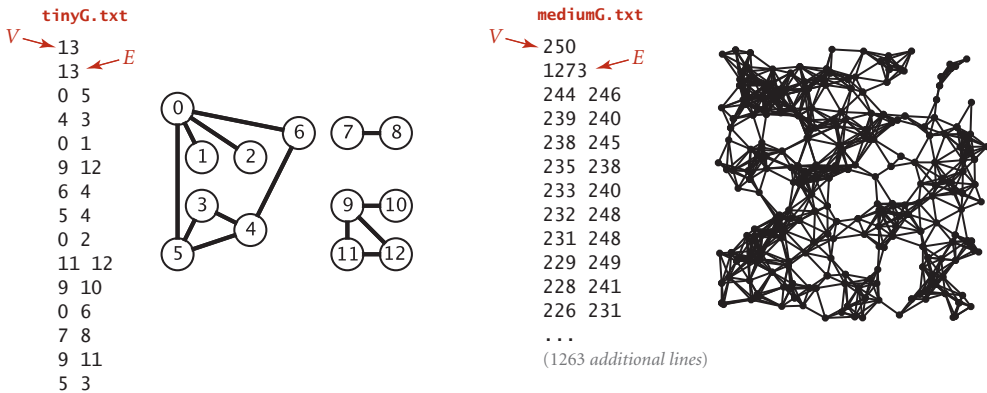

Input format for `Graph` constructor (two examples)

task	implementation
<i>compute the degree of v</i>	<pre>public static int degree(Graph G, int v) { int degree = 0; for (int w : G.adj(v)) degree++; return degree; }</pre>
<i>compute maximum degree</i>	<pre>public static int maxDegree(Graph G) { int max = 0; for (int v = 0; v < G.V(); v++) if (degree(G, v) > max) max = degree(G, v); return max; }</pre>
<i>compute average degree</i>	<pre>public static int avgDegree(Graph G) { return 2 * G.E() / G.V(); }</pre>
<i>count self-loops</i>	<pre>public static int numberOfSelfLoops(Graph G) { int count = 0; for (int v = 0; v < G.V(); v++) for (int w : G.adj(v)) if (v == w) count++; return count/2; // each edge counted twice }</pre>
<i>string representation of the graph's adjacency lists (instance method in Graph)</i>	<pre>public String toString() { String s = V + " vertices, " + E + " edges\n"; for (int v = 0; v < V; v++) { s += v + ": "; for (int w : this.adj(v)) s += w + " "; s += "\n"; } return s; }</pre>

Typical graph-processing code

Representation alternatives. The next decision that we face in graph processing is which graph representation (data structure) to use to implement this API. We have two basic requirements:

- We must have the *space* to accommodate the types of graphs that we are likely to encounter in applications.
- We want to develop *time*-efficient implementations of Graph instance methods—the basic methods that we need to develop graph-processing clients.

These requirements are a bit vague, but they are still helpful in choosing among the three data structures that immediately suggest themselves for representing graphs:

- An *adjacency matrix*, where we maintain a V -by- V boolean array, with the entry in row v and column w defined to be `true` if there is an edge adjacent to both vertex v and vertex w in the graph, and to be `false` otherwise. This representation fails on the first count—graphs with millions of vertices are common and the space cost for the V^2 boolean values needed is prohibitive.
- An *array of edges*, using an `Edge` class with two instance variables of type `int`. This direct representation is simple, but it fails on the second count—implementing `adj()` would involve examining all the edges in the graph.
- An *array of adjacency lists*, where we maintain a vertex-indexed array of lists of the vertices adjacent to each vertex. This data structure satisfies both requirements for typical applications and is the one that we will use throughout this chapter.

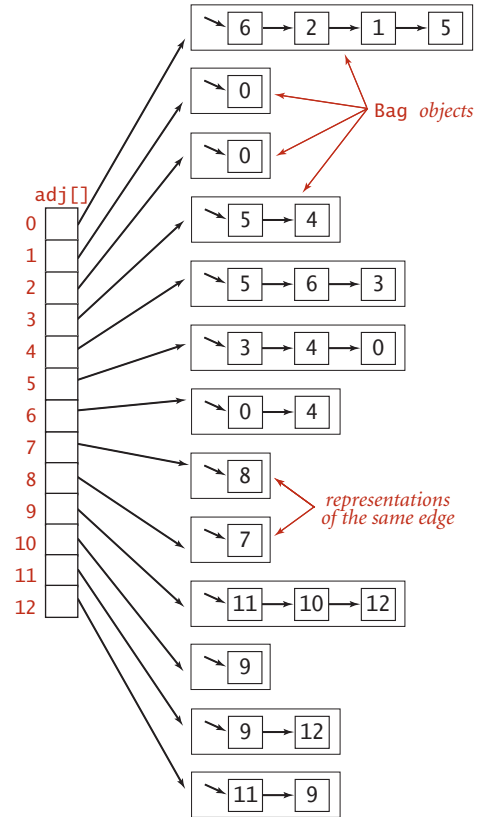

Adjacency-lists representation (undirected graph)

Beyond these performance objectives, a detailed examination reveals other considerations that can be important in some applications. For example, allowing parallel edges precludes the use of an adjacency matrix, since the adjacency matrix has no way to represent them.

Adjacency-lists data structure. The standard graph representation for graphs that are not dense is called the *adjacency-lists data structure*, where we keep track of all the vertices adjacent to each vertex on a linked list that is associated with that vertex. We maintain an array of lists so that, given a vertex, we can immediately access its list. To implement lists, we use our Bag ADT from SECTION 1.3 with a linked-list implementation, so that we can add new edges in constant time and iterate through adjacent vertices in constant time per adjacent vertex. The Graph implementation on page 526 is based on this approach, and the figure on the facing page depicts the data structures built by this code for `tinyG.txt`. To add an edge connecting v and w , we add w to v 's adjacency list and v to w 's adjacency list. Thus, each edge appears *twice* in the data structure. This Graph implementation achieves the following performance characteristics:

- Space usage proportional to $V + E$
- Constant time to add an edge
- Time proportional to the degree of v to iterate through vertices adjacent to v (constant time per adjacent vertex processed)

These characteristics are optimal for this set of operations, which suffice for the graph-processing applications that we consider. Parallel edges and self-loops are allowed (we do not check for them). *Note:* It is important to realize that the order in which edges are added to the graph determines the order in which vertices appear in the array of adjacency lists built by Graph. Many different arrays of adjacency lists can represent the same graph.

When using the constructor that reads edges from an input stream, this means that the input format and the order in which edges are specified in the file determine the order in which vertices appear in the array of adjacency lists built by Graph. Since our algorithms use `adj()` and process all adjacent vertices without regard to the order in which they appear in the lists, this difference does not affect their correctness, but it is important to bear it in mind when debugging or following traces. To facilitate these activities, we assume that Graph has a test client that reads a graph from the input stream named as command-line argument and then prints it (relying on the `toString()` implementation on page 523) to show the order in which vertices appear in adjacency lists, which is the order in which algorithms process them (see EXERCISE 4.1.7).

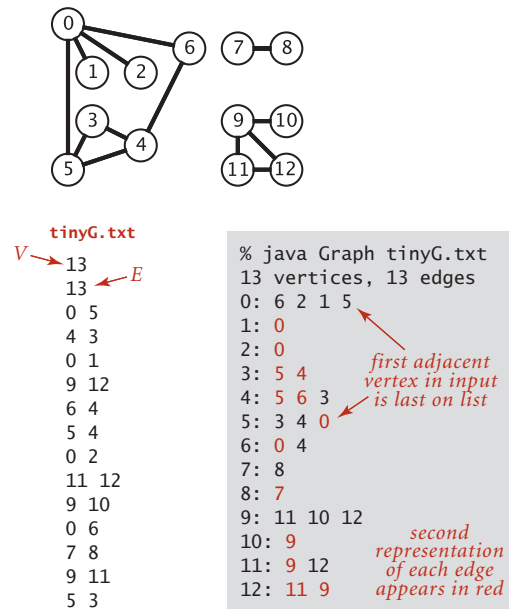

Output for list-of-edges input

Graph data type

```

public class Graph
{
    private final int V;           // number of vertices
    private int E;                // number of edges
    private Bag<Integer>[] adj;   // adjacency lists

    public Graph(int V)
    {
        this.V = V; this.E = 0;
        adj = (Bag<Integer>[]) new Bag[V]; // Create array of lists.
        for (int v = 0; v < V; v++)      // Initialize all lists
            adj[v] = new Bag<Integer>(); // to empty.
    }

    public Graph(In in)
    {
        this(in.readInt()); // Read V and construct this graph.
        int E = in.readInt(); // Read E.
        for (int i = 0; i < E; i++)
        { // Add an edge.
            int v = in.readInt(); // Read a vertex,
            int w = in.readInt(); // read another vertex,
            addEdge(v, w);        // and add edge connecting them.
        }
    }

    public int V() { return V; }
    public int E() { return E; }

    public void addEdge(int v, int w)
    {
        adj[v].add(w); // Add w to v's list.
        adj[w].add(v); // Add v to w's list.
        E++;
    }

    public Iterable<Integer> adj(int v)
    { return adj[v]; }
}

```

This Graph implementation maintains a vertex-indexed array of lists of integers. Every edge appears twice: if an edge connects v and w , then w appears in v 's list and v appears in w 's list. The second constructor reads a graph from an input stream, in the format V followed by E followed by a list of pairs of `int` values between 0 and $V-1$. See page 523 for `toString()`.

IT IS CERTAINLY REASONABLE to contemplate other operations that might be useful in applications, and to consider methods for

- Adding a vertex
- Deleting a vertex

One way to handle such operations is to expand the API to use a symbol table (ST) instead of a vertex-indexed array (with this change we also do not need our convention that vertex names be integer indices). We might also consider methods for

- Deleting an edge
- Checking whether the graph contains the edge $v-w$

To implement these methods (and disallow parallel edges) we might use a SET instead of a Bag for adjacency lists. We refer to this alternative as an *adjacency set* representation. We do not use these alternatives in this book for several reasons:

- Our clients do not need to add vertices, delete vertices and edges, or check whether an edge exists.
- When clients do need these operations, they typically are invoked infrequently or for short adjacency lists, so an easy option is to use a brute-force implementation that iterates through an adjacency list.
- The SET and ST representations slightly complicate algorithm implementation code, diverting attention from the algorithms themselves.
- A performance penalty of $\log V$ may be involved in some situations.

It is not difficult to adapt our algorithms to accommodate other designs (for example disallowing parallel edges or self-loops) without undue performance penalties. The table below summarizes performance characteristics of the alternatives that we have mentioned. Typical applications process huge sparse graphs, so we use the adjacency-lists representation throughout.

underlying data structure	space	add edge $v-w$	check whether w is adjacent to v	iterate through vertices adjacent to v
<i>list of edges</i>	E	1	E	E
<i>adjacency matrix</i>	V^2	1	1	V
<i>adjacency lists</i>	$E + V$	1	$degree(v)$	$degree(v)$
<i>adjacency sets</i>	$E + V$	$\log V$	$\log V$	$\log V + degree(v)$

Order-of-growth performance for typical Graph implementations

Design pattern for graph processing. Since we consider a large number of graph-processing algorithms, our initial design goal is to decouple our implementations from the graph representation. To do so, we develop, for each given task, a task-specific class so that clients can create objects to perform the task. Generally, the constructor does some preprocessing to build data structures so as to efficiently respond to client queries. A typical client program builds a graph, passes that graph to an algorithm implementation class (as argument to a constructor), and then calls client query methods to learn various properties of the graph. As a warmup, consider this API:

```
public class Search
```

```
    Search(Graph G, int s) find vertices connected to a source vertex s  
    boolean marked(int v) is v connected to s?  
    int count() how many vertices are connected to s?
```

Graph-processing API (warmup)

We use the term *source* to distinguish the vertex provided as argument to the constructor from the other vertices in the graph. In this API, the job of the constructor is to find the vertices in the graph that are connected to the source. Then client code calls the instance methods `marked()` and `count()` to learn characteristics of the graph. The name `marked()` refers to an approach used by the basic algorithms that we consider throughout this chapter: they follow paths from the source to other vertices in the graph, marking each vertex encountered. The example client `TestSearch` shown on the facing page takes an input stream name and a source vertex number from the command line, reads a graph from the input stream (using the second `Graph` constructor), builds a `Search` object for the given graph and source, and uses `marked()` to print the vertices in that graph that are connected to the source. It also calls `count()` and prints whether or not the graph is connected (the graph is connected if and only if the search marked all of its vertices).

WE HAVE ALREADY SEEN one way to implement the Search API: the union-find algorithms of CHAPTER 1. The constructor can build a UF object, do a `union()` operation for each of the graph's edges, and implement `marked(v)` by calling `connected(s, v)`. Implementing `count()` requires using a weighted UF implementation and extending its API to use a `count()` method that returns `wt[find(v)]` (see EXERCISE 4.1.8). This implementation is simple and efficient, but the implementation that we consider next is even simpler and more efficient. It is based on *depth-first search*, a fundamental recursive method that follows the graph's edges to find the vertices connected to the source. Depth-first search is the basis for several of the graph-processing algorithms that we consider throughout this chapter.

```
public class TestSearch
{
    public static void main(String[] args)
    {
        Graph G = new Graph(new In(args[0]));
        int s = Integer.parseInt(args[1]);
        Search search = new Search(G, s);

        for (int v = 0; v < G.V(); v++)
            if (search.marked(v))
                StdOut.print(v + " ");
            StdOut.println();

        if (search.count() != G.V())
            StdOut.print("NOT ");
        StdOut.println("connected");
    }
}
```

Sample graph-processing client (warmup)

```
% java TestSearch tinyG.txt 0
0 1 2 3 4 5 6
NOT connected

% java TestSearch tinyG.txt 9
9 10 11 12
NOT connected
```

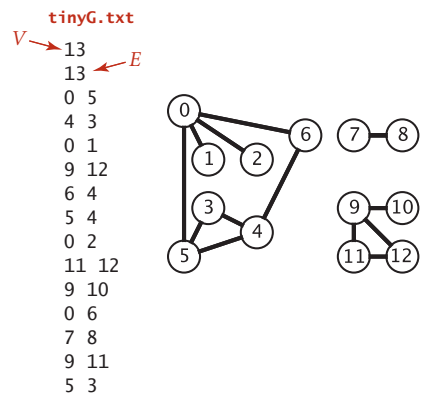

Depth-first search We often learn properties of a graph by systematically examining each of its vertices and each of its edges. Determining some simple graph properties—for example, computing the degrees of all the vertices—is easy if we just examine each edge (in any order whatever). But many other graph properties are related to paths, so a natural way to learn them is to move from vertex to vertex along the graph’s

edges. Nearly all of the graph-processing algorithms that we consider use this same basic abstract model, albeit with various different strategies. The simplest is a classic method that we now consider.

Searching in a maze. It is instructive to think about the process of searching through a graph in terms of an equivalent problem that has a long and distinguished history—finding our way through a maze that consists of passages connected by intersections. Some mazes can be handled with a simple rule, but most mazes require a more sophisticated strategy. Using the terminology *maze* instead of *graph*, *passage* instead of *edge*, and *intersection* instead of *vertex* is making mere semantic distinctions, but, for the moment, doing so will help to

give us an intuitive feel for the problem. One trick for exploring a maze without getting lost that has been known since antiquity (dating back at least to the legend of Theseus and the Minotaur) is known as *Tremaux exploration*. To explore all passages in a maze:

- Take any unmarked passage, unrolling a string behind you.
- Mark all intersections and passages when you first visit them.
- Retrace steps (using the string) when approaching a marked intersection.
- Retrace steps when no unvisited options remain at an intersection encountered while retracing steps.

The string guarantees that you can always find a way out and the marks guarantee that you avoid visiting any passage or intersection twice. Knowing that you have explored the whole maze demands a more complicated argument that is better approached in the context of graph search. Tremaux exploration is an intuitive starting point, but it differs in subtle ways from exploring a graph, so we now move on to searching in graphs.

maze

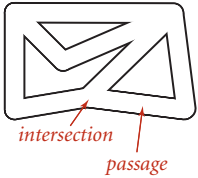

graph

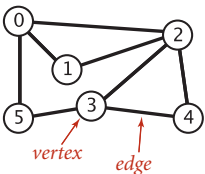

Equivalent models of a maze

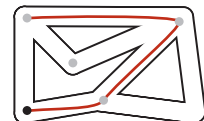
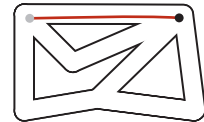

Tremaux exploration

Warmup. The classic recursive method for searching in a connected graph (visiting all of its vertices and edges) mimics Tremaux maze exploration but is even simpler to describe. To search a graph, invoke a recursive method that visits vertices. To visit a vertex:

- Mark it as having been visited.
- Visit (recursively) all the vertices that are adjacent to it and that have not yet been marked.

This method is called *depth-first search* (DFS). An implementation of our Search API using this method is shown at right. It maintains an array of `boolean` values to mark all of the vertices that are connected to the source. The recursive method marks the given vertex and calls itself for any unmarked vertices on its adjacency list. If the graph is connected, every adjacency-list entry is checked.

```
public class DepthFirstSearch
{
    private boolean[] marked;
    private int count;

    public DepthFirstSearch(Graph G, int s)
    {
        marked = new boolean[G.V()];
        dfs(G, s);
    }

    private void dfs(Graph G, int v)
    {
        marked[v] = true;
        count++;
        for (int w : G.adj(v))
            if (!marked[w]) dfs(G, w);
    }

    public boolean marked(int w)
    { return marked[w]; }

    public int count()
    { return count; }
}
```

Depth-first search

Proposition A. DFS marks all the vertices connected to a given source in time proportional to the sum of their degrees.

Proof: First, we prove that the algorithm marks all the vertices connected to the source s (and no others). Every marked vertex is connected to s , since the algorithm finds vertices only by following edges. Now, suppose that some unmarked vertex w is connected to s . Since s itself is marked, any path from s to w must have at least one edge from the set of marked vertices to the set of unmarked vertices, say v - x . But the algorithm would have discovered x after marking v , so no such edge can exist, a contradiction. The time bound follows because marking ensures that each vertex is visited once (taking time proportional to its degree to check marks).

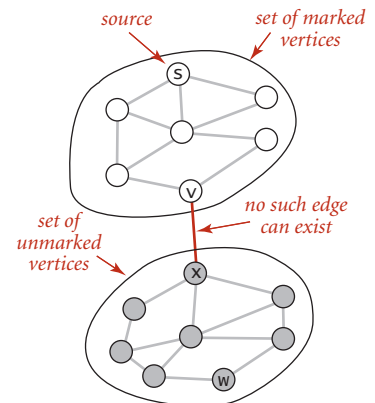

One-way passages. The method call–return mechanism in the program corresponds to the string in the maze: when we have processed all the edges incident to a vertex (explored all the passages leaving an intersection), we “return” (in both senses of the word). To draw a proper correspondence with Tremaux exploration of a maze, we need to imagine a maze constructed entirely of one-way passages (one in each direction).

tinyCG.txt

```

V → 6
      8 ← E
0 5
2 4
2 3
1 2
0 1
3 4
3 5
0 2

```

standard drawing

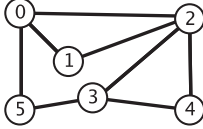

drawing with both edges

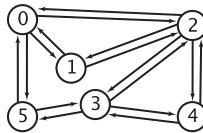

adjacency lists

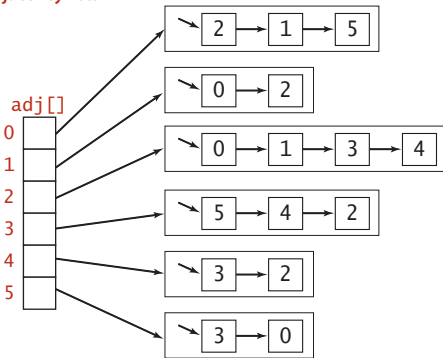

A connected undirected graph

after 0 because it happens to be first on 0’s adjacency list. The second thing to bear in mind when doing a trace is that, as mentioned above, DFS traverses each edge in the graph twice, always finding a marked vertex the second time. One effect of this observation is that tracing a DFS takes twice as long as you might think! Our example graph has only eight edges, but we need to trace the action of the algorithm on the 16 entries on the adjacency lists.

In the same way that we encounter each passage in the maze twice (once in each direction), we encounter each edge in the graph *twice* (once at each of its vertices). In Tremaux exploration, we either explore a passage for the first time or return along it from a marked vertex; in DFS of an undirected graph, we either do a recursive call when we encounter an edge $v-w$ (if w is not marked) or skip the edge (if w is marked). The second time that we encounter the edge, in the opposite orientation $w-v$, we always ignore it, because the destination vertex v has certainly already been visited (the first time that we encountered the edge).

Tracing DFS. As usual, one good way to understand an algorithm is to trace its behavior on a small example. This is particularly true of depth-first search. The first thing to bear in mind when doing a trace is that the order in which edges are examined and vertices visited depends upon the *representation*, not just the graph or the algorithm. Since DFS only examines vertices connected to the source, we use the small connected graph depicted at left as an example for traces. In this example, vertex 2 is the first vertex visited

Detailed trace of depth-first search. The figure at right shows the contents of the data structures just after each vertex is marked for our small example, with source 0. The search begins when the constructor calls the recursive `dfs()` to mark and visit vertex 0 and proceeds as follows:

- Since 2 is first on 0's adjacency list and is unmarked, `dfs()` recursively calls itself to mark and visit 2 (in effect, the system puts 0 and the current position on 0's adjacency list on a stack).
- Now, 0 is first on 2's adjacency list and is marked, so `dfs()` skips it. Then, since 1 is next on 2's adjacency list and is unmarked, `dfs()` recursively calls itself to mark and visit 1.
- Visiting 1 is different: since both vertices on its list (0 and 2) are already marked, no recursive calls are needed, and `dfs()` returns from the recursive call `dfs(1)`. The next edge examined is 2-3 (since 3 is the vertex after 1 on 2's adjacency list), so `dfs()` recursively calls itself to mark and visit 3.
- Vertex 5 is first on 3's adjacency list and is unmarked, so `dfs()` recursively calls itself to mark and visit 5.
- Both vertices on 5's list (3 and 0) are already marked, so no recursive calls are needed,
- Vertex 4 is next on 3's adjacency list and is unmarked, so `dfs()` recursively calls itself to mark and visit 4, the last vertex to be marked.
- After 4 is marked, `dfs()` needs to check the vertices on its list, then the remaining vertices on 3's list, then 2's list, then 0's list, but no more recursive calls happen because all vertices are marked.

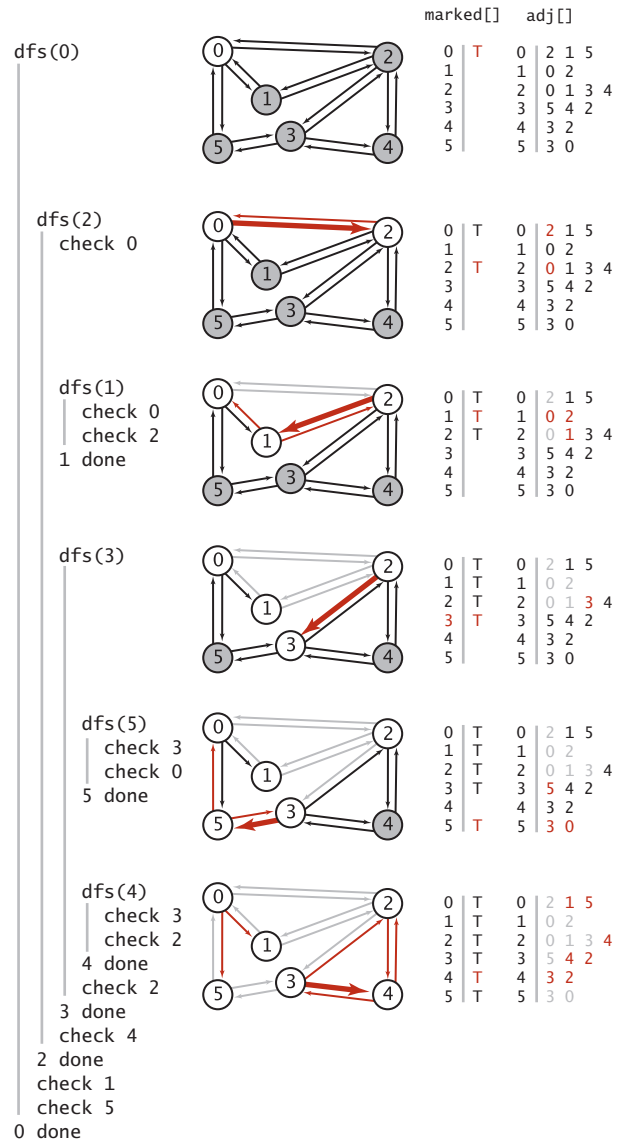

Trace of depth-first search to find vertices connected to 0

THIS BASIC RECURSIVE SCHEME IS JUST A START—depth-first search is effective for many graph-processing tasks. For example, in this section, we consider the use of depth-first search to address a problem that we first posed in CHAPTER 1:

Connectivity. Given a graph, support queries of the form *Are two given vertices connected?* and *How many connected components does the graph have?*

This problem is easily solved within our standard graph-processing design pattern, and we will compare and contrast this solution with the union-find algorithms that we considered in SECTION 1.5.

The question “Are two given vertices connected?” is equivalent to the question “Is there a path connecting two given vertices?” and might be named the *path detection* problem. However, the union-find data structures that we considered in SECTION 1.5 do not address the problems of *finding* such a path. Depth-first search is the first of several approaches that we consider to solve this problem, as well:

Single-source paths. Given a graph and a source vertex s , support queries of the form *Is there a path from s to a given target vertex v ? If so, find such a path.*

DFS is deceptively simple because it is based on a familiar concept and is so easy to implement; in fact, it is a subtle and powerful algorithm that researchers have learned to put to use to solve numerous difficult problems. These two are the first of several that we will consider.

Finding paths The single-source paths problem is fundamental to graph processing. In accordance with our standard design pattern, we use the following API:

```
public class Paths
    Paths(Graph G, int s) find paths in G from source s
    boolean hasPathTo(int v) is there a path from s to v?
    Iterable<Integer> pathTo(int v) path from s to v; null if no such path
```

API for paths implementations

The constructor takes a source vertex s as argument and computes paths from s to each vertex connected to s . After creating a `Paths` object for a source s , the client can use the instance method `pathTo()` to iterate through the vertices on a path from s to any vertex connected to s . For the moment, we accept any path; later, we shall develop implementations that find paths having certain properties. The test client at right takes a graph from the input stream and a source from the command line and prints a path from the source to each vertex connected to it.

```
public static void main(String[] args)
{
    Graph G = new Graph(new In(args[0]));
    int s = Integer.parseInt(args[1]);
    Paths search = new Paths(G, s);
    for (int v = 0; v < G.V(); v++)
    {
        StdOut.print(s + " to " + v + ": ");
        if (search.hasPathTo(v))
            for (int x : search.pathTo(v))
                if (x == s) StdOut.print(x);
                else StdOut.print("-" + x);
        StdOut.println();
    }
}
```

Test client for paths implementations

Implementation. ALGORITHM 4.1 on page 536 is a DFS-based implementation of `Paths` that extends the `DepthFirstSearch` warmup on page 531 by adding as an instance variable an array `edgeTo[]` of `int` values that serves the purpose of the ball of string in Tremaux exploration: it gives a way to find a path back to s for every vertex connected to s . Instead of just keeping track of the path from the current vertex back to the start,

```
% java Paths tinyCG.txt 0
0 to 0: 0
0 to 1: 0-2-1
0 to 2: 0-2
0 to 3: 0-2-3
0 to 4: 0-2-3-4
0 to 5: 0-2-3-5
```

we remember a path from *each* vertex to the start. To accomplish this, we remember the edge $v-w$ that takes us to each vertex w for the first time, by setting `edgeTo[w]` to v . In other words, $v-w$ is the last edge on the known path from s to w . The result of the search is a tree rooted at the source; `edgeTo[]` is a parent-link representation of that tree. A small example is drawn to

ALGORITHM 4.1 Depth-first search to find paths in a graph

```

public class DepthFirstPaths
{
    private boolean[] marked; // Has dfs() been called for this vertex?
    private int[] edgeTo;    // last vertex on known path to this vertex
    private final int s;    // source

    public DepthFirstPaths(Graph G, int s)
    {
        marked = new boolean[G.V()];
        edgeTo = new int[G.V()];
        this.s = s;
        dfs(G, s);
    }

    private void dfs(Graph G, int v)
    {
        marked[v] = true;
        for (int w : G.adj(v))
            if (!marked[w])
            {
                edgeTo[w] = v;
                dfs(G, w);
            }
    }

    public boolean hasPathTo(int v)
    { return marked[v]; }

    public Iterable<Integer> pathTo(int v)
    {
        if (!hasPathTo(v)) return null;
        Stack<Integer> path = new Stack<Integer>();
        for (int x = v; x != s; x = edgeTo[x])
            path.push(x);
        path.push(s);
        return path;
    }
}

```

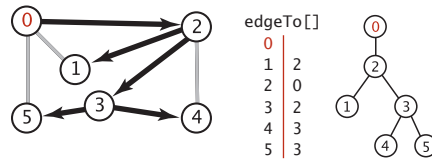

x	path
5	5
3	3 5
2	2 3 5
0	0 2 3 5

Trace of pathTo(5) computation

This Graph client uses depth-first search to find paths to all the vertices in a graph that are connected to a given start vertex s . Code from `DepthFirstSearch` (page 531) is printed in gray. To save known paths to each vertex, this code maintains a vertex-indexed array `edgeTo[]` such that `edgeTo[w] = v` means that $v-w$ was the edge used to access w for the first time. The `edgeTo[]` array is a parent-link representation of a tree rooted at s that contains all the vertices connected to s .

the right of the code in ALGORITHM 4.1. To recover the path from s to any vertex v , the `pathTo()` method in ALGORITHM 4.1 uses a variable x to travel up the tree, setting x to `edgeTo[x]`, just as we did for `union-find` in SECTION 1.5, putting each vertex encountered onto a stack until reaching s . Returning the stack to the client as an `Iterable` enables the client to follow the path from s to v .

Detailed trace. The figure at right shows the contents of `edgeTo[]` just after each vertex is marked for our example, with source 0. The contents of `marked[]` and `adj[]` are the same as in the trace of `DepthFirstSearch` on page 533, as is the detailed description of the recursive calls and the edges checked, so these aspects of the trace are omitted. The depth-first search adds the edges 0-2, 2-1, 2-3, 3-5, and 3-4 to `edgeTo[]`, in that order. These edges form a tree rooted at the source and provide the information needed for `pathTo()` to provide for the client the path from 0 to 1, 2, 3, 4, or 5, as just described.

THE CONSTRUCTOR in `DepthFirstPaths` differs only in a few assignment statements from the constructor in `DepthFirstSearch`, so PROPOSITION A on page 531 applies. In addition, we have:

Proposition A (continued). DFS allows us to provide clients with a path from a given source to any marked vertex in time proportional its length.

Proof: By induction on the number of vertices visited, it follows that the `edgeTo[]` array in `DepthFirstPaths` represents a tree rooted at the source. The `pathTo()` method builds the path in time proportional to its length.

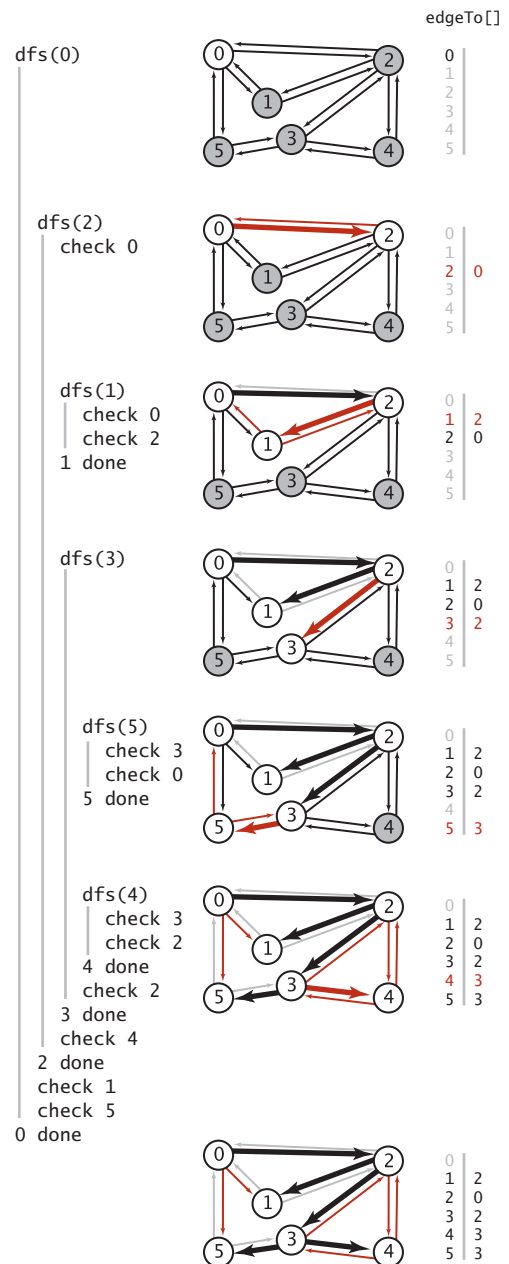

Trace of depth-first search to find all paths from 0

Breadth-first search The paths discovered by depth-first search depend not just on the graph, but also on the representation and the nature of the recursion. Naturally, we are often interested in solving the following problem:

Single-source shortest paths. Given a graph and a source vertex s , support queries of the form *Is there a path from s to a given target vertex v ?* If so, find a *shortest* such path (one with a minimal number of edges).

The classical method for accomplishing this task, called *breadth-first search* (BFS), is also the basis of numerous algorithms for processing graphs, so we consider it in detail in this section. DFS offers us little assistance in solving this problem, because the order in which it takes us through the graph has no relationship to the goal of finding shortest paths. In contrast, BFS is based on this goal. To find a shortest path from s to v , we start at s and check for v among all the vertices that we can reach by following one edge, then we check for v among all the vertices that we can reach from s by following two edges, and so forth. DFS is analogous to one person exploring a maze. BFS is analogous to a group of searchers exploring by fanning out in all directions, each unrolling his or her own ball of string. When more than one passage needs to be explored, we imagine that the searchers split up to explore all of them; when two groups of searchers meet up, they join forces (using the ball of string held by the one getting there first).

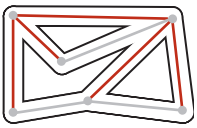
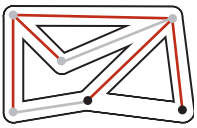
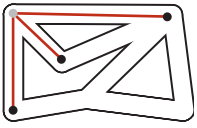

Breadth-first
maze exploration

In a program, when we come to a point during a graph search where we have more than one edge to traverse, we choose one and save the others to be explored later. In DFS, we use a pushdown stack (that is managed by the system to support the recursive search method) for this purpose. Using the LIFO rule that characterizes the pushdown stack corresponds to exploring passages that are close by in a maze. We choose, of the passages yet to be explored, the one that was most recently encountered. In BFS, we want to explore the vertices in order of their distance from the source. It turns out that this order is easily arranged: use a (FIFO) queue instead of a (LIFO) stack. We choose, of the passages yet to be explored, the one that was least recently encountered.

Implementation. ALGORITHM 4.2 on page 540 is an implementation of BFS. It is based on maintaining a queue of all vertices that have been marked but whose adjacency lists have not been checked. We put the source vertex on the queue, then perform the following steps until the queue is empty:

- Take the next vertex v from the queue and mark it.
- Put onto the queue all unmarked vertices that are adjacent to v .

The `bfs()` method in ALGORITHM 4.2 is *not* recursive. Instead of the implicit stack provided by recursion, it uses an explicit queue. The product of the search, as for DFS, is an array `edgeTo[]`, a parent-link representation of a tree rooted at `s`, which defines the shortest paths from `s` to every vertex that is connected to `s`. The paths can be constructed for the client using the same `pathTo()` implementation that we used for DFS in ALGORITHM 4.1.

The figure at right shows the step-by-step development of BFS on our sample graph, showing the contents of the data structures at the beginning of each iteration of the loop. Vertex 0 is put on the queue, then the loop completes the search as follows:

- Removes 0 from the queue and puts its adjacent vertices 2, 1, and 5 on the queue, marking each and setting the `edgeTo[]` entry for each to 0.
- Removes 2 from the queue, checks its adjacent vertices 0 and 1, which are marked, and puts its adjacent vertices 3 and 4 on the queue, marking each and setting the `edgeTo[]` entry for each to 2.
- Removes 1 from the queue and checks its adjacent vertices 0 and 2, which are marked.
- Removes 5 from the queue and checks its adjacent vertices 3 and 0, which are marked.
- Removes 3 from the queue and checks its adjacent vertices 5, 4, and 2, which are marked.
- Removes 4 from the queue and checks its adjacent vertices 3 and 2, which are marked.

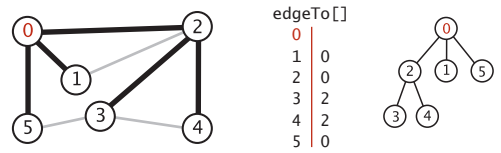

Outcome of breadth-first search to find all paths from 0

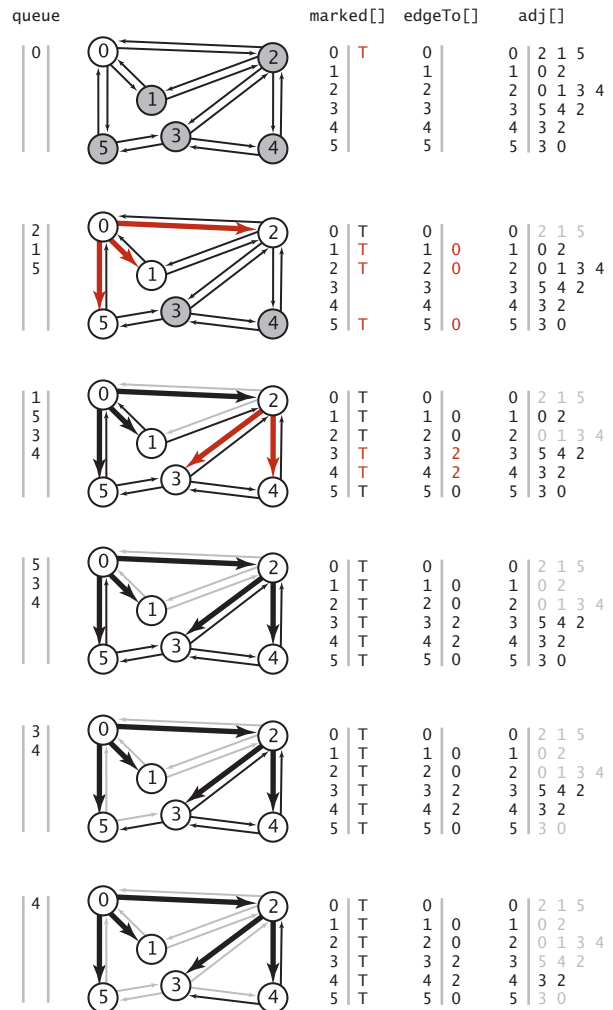

Trace of breadth-first search to find all paths from 0

ALGORITHM 4.2 Breadth-first search to find paths in a graph

```

public class BreadthFirstPaths
{
    private boolean[] marked; // Is a shortest path to this vertex known?
    private int[] edgeTo;    // last vertex on known path to this vertex
    private final int s;    // source

    public BreadthFirstPaths(Graph G, int s)
    {
        marked = new boolean[G.V()];
        edgeTo = new int[G.V()];
        this.s = s;
        bfs(G, s);
    }

    private void bfs(Graph G, int s)
    {
        Queue<Integer> queue = new Queue<Integer>();
        marked[s] = true;    // Mark the source
        queue.enqueue(s);    // and put it on the queue.
        while (!q.isEmpty())
        {
            int v = queue.dequeue(); // Remove next vertex from the queue.
            for (int w : G.adj(v))
                if (!marked[w])    // For every unmarked adjacent vertex,
                {
                    edgeTo[w] = v;    // save last edge on a shortest path,
                    marked[w] = true; // mark it because path is known,
                    queue.enqueue(w); // and add it to the queue.
                }
        }
    }

    public boolean hasPathTo(int v)
    { return marked[v]; }

    public Iterable<Integer> pathTo(int v)
    // Same as for DFS (see page 536).
}

```

This Graph client uses breadth-first search to find paths in a graph with the fewest number of edges from the source s given in the constructor. The `bfs()` method marks all vertices connected to s , so clients can use `hasPathTo()` to determine whether a given vertex v is connected to s and `pathTo()` to get a path from s to v with the property that no other such path from s to v has fewer edges.

For this example, the `edgeTo[]` array is complete after the second step. As with DFS, once all vertices have been marked, the rest of the computation is just checking edges to vertices that have already been marked.

Proposition B. For any vertex v reachable from s , BFS computes a shortest path from s to v (no path from s to v has fewer edges).

Proof: It is easy to prove by induction that the queue always consists of zero or more vertices of distance k from the source, followed by zero or more vertices of distance $k+1$ from the source, for some integer k , starting with k equal to 0. This property implies, in particular, that vertices enter and leave the queue in order of their distance from s . When a vertex v enters the queue, no shorter path to v will be found before it comes off the queue, and no path to v that is discovered after it comes off the queue can be shorter than v 's tree path length.

Proposition B (continued). BFS takes time proportional to $V+E$ in the worst case.

Proof: As for PROPOSITION A (page 531), BFS marks all the vertices connected to s in time proportional to the sum of their degrees. If the graph is connected, this sum is the sum of the degrees of all the vertices, or $2E$.

Note that we can also use BFS to implement the Search API that we implemented with DFS, since the solution depends on only the ability of the search to examine every vertex and edge connected to the source.

As implied at the outset, DFS and BFS are the first of several instances that we will examine of a general approach to searching graphs. We put the source vertex on the data structure, then perform the following steps until the data structure is empty:

- Take the next vertex v from the data structure and mark it.
- Put onto the data structure all unmarked vertices that are adjacent to v .

The algorithms differ only in the rule used to take the next vertex from the data structure (least recently added for BFS, most recently added for DFS). This difference leads to completely different views of the graph, even though all the vertices and edges connected to the source are examined no matter what rule is used.

```
% java BreadthFirstPaths tinyCG.txt 0
0 to 0: 0
0 to 1: 0-1
0 to 2: 0-2
0 to 3: 0-2-3
0 to 4: 0-2-4
0 to 5: 0-5
```

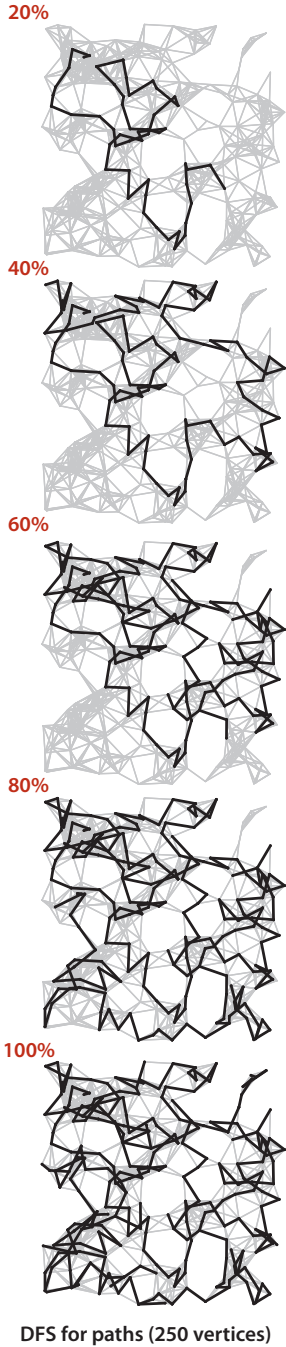

THE DIAGRAMS ON EITHER SIDE of this page, which show the progress of DFS and BFS for our sample graph `mediumG.txt`, make plain the differences between the paths that are discovered by the two approaches. DFS wends its way through the graph, storing on the stack the points where other paths branch off; BFS sweeps through the graph, using a queue to remember the frontier of visited places. DFS explores the graph by looking for new vertices far away from the start point, taking closer vertices only when dead ends are encountered; BFS completely covers the area close to the starting point, moving farther away only when everything nearby has been examined. DFS paths tend to be long and winding; BFS paths are short and direct. Depending upon the application, one property or the other may be desirable (or properties of paths may be immaterial). In SECTION 4.4, we will be considering other implementations of the Paths API that find paths having other specified properties.

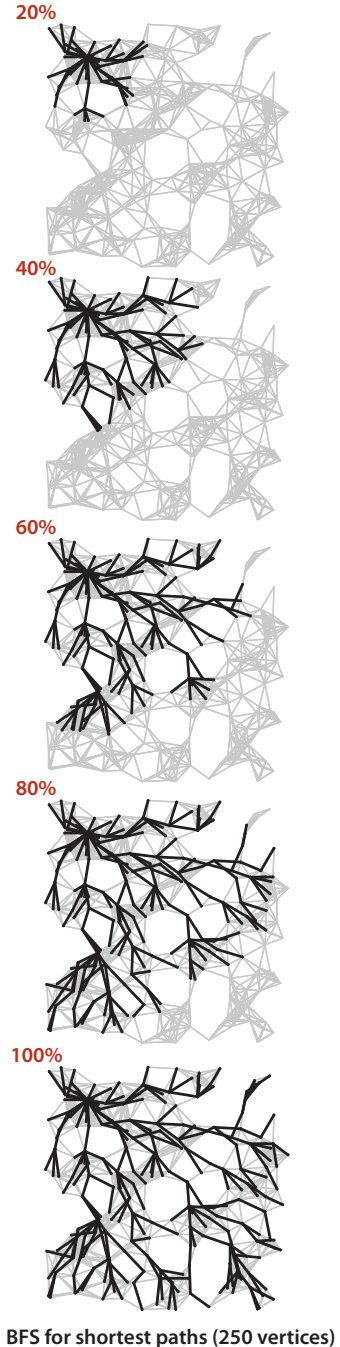

Connected components Our next direct application of depth-first search is to find the connected components of a graph. Recall from SECTION 1.5 (see page 216) that “is connected to” is an *equivalence relation* that divides the vertices into *equivalence classes* (the connected components). For this common graph-processing task, we define the following API:

```
public class CC
    CC(Graph G)                preprocessing constructor
    boolean connected(int v, int w) are v and w connected?
    int count()                number of connected components
    int id(int v)              component identifier for v
                              (between 0 and count()-1)
```

API for connected components

The `id()` method is for client use in indexing an array by component, as in the test client below, which reads a graph and then prints its number of connected components and then the vertices in each component, one component per line. To do so, it builds an array of `Bag` objects, then uses each vertex’s component identifier as an index into this array, to add the vertex to the appropriate `Bag`. This client is a model for the typical situation where we want to independently process connected components.

Implementation. The implementation `CC` (ALGORITHM 4.3 on the next page) uses our `marked[]` array to find a vertex to serve as the starting point for a depth-first search in each component. The first call to the recursive DFS is for vertex 0—it marks all vertices connected to 0. Then the `for` loop in the constructor looks for an unmarked vertex and calls the recursive `dfs()` to mark all vertices connected to that vertex. Moreover, it maintains a vertex-indexed array `id[]` that associates the same `int` value to every vertex in each component. This array makes the implementation of `connected()` simple, in precisely the same manner as

```
public static void main(String[] args)
{
    Graph G = new Graph(new In(args[0]));
    CC cc = new CC(G);

    int M = cc.count();
    StdOut.println(M + " components");

    Bag<Integer>[] components;
    components = (Bag<Integer>[]) new Bag[M];
    for (int i = 0; i < M; i++)
        components[i] = new Bag<Integer>();
    for (int v = 0; v < G.V(); v++)
        components[cc.id(v)].add(v);
    for (int i = 0; i < M; i++)
    {
        for (int v: components[i])
            StdOut.print(v + " ");
        StdOut.println();
    }
}
```

Test client for connected components API

ALGORITHM 4.3 Depth-first search to find connected components in a graph

```

public class CC
{
    private boolean[] marked;
    private int[] id;
    private int count;

    public CC(Graph G)
    {
        marked = new boolean[G.V()];
        id = new int[G.V()];
        for (int s = 0; s < G.V(); s++)
            if (!marked[s])
            {
                dfs(G, s);
                count++;
            }
    }

    private void dfs(Graph G, int v)
    {
        marked[v] = true;
        id[v] = count;
        for (int w : G.adj(v))
            if (!marked[w])
                dfs(G, w);
    }

    public boolean connected(int v, int w)
    { return id[v] == id[w]; }

    public int id(int v)
    { return id[v]; }

    public int count()
    { return count; }
}

```

```

% more tinyG.txt
13 vertices, 13 edges
0: 6 2 1 5
1: 0
2: 0
3: 5 4
4: 5 6 3
5: 3 4 0
6: 0 4
7: 8
8: 7
9: 11 10 12
10: 9
11: 9 12
12: 11 9

% java CC tinyG.txt
3 components
6 5 4 3 2 1 0
8 7
12 11 10 9

```

This Graph client provides its clients with the ability to independently process a graph's connected components. Code from `DepthFirstSearch` (page 531) is left in gray. The computation is based on a vertex-indexed array `id[]` such that `id[v]` is set to `i` if `v` is in the `i`th connected component processed. The constructor finds an unmarked vertex and calls the recursive `dfs()` to mark and identify all the vertices connected to it, continuing until all vertices have been marked and identified. Implementations of the instance methods `connected()`, `id()`, and `count()` are immediate.

tinyG.txt

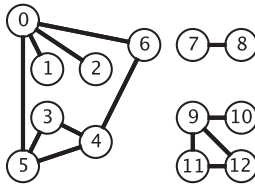

	count	marked[]	id[]
	0 1 2 3 4 5 6 7 8 9 10 11 12	0 1 2 3 4 5 6 7 8 9 10 11 12	0 1 2 3 4 5 6 7 8 9 10 11 12
dfs(0)	0	T	0
dfs(6)	0	T	0
check 0			
dfs(4)	0	T	0
dfs(5)	0	T	0
dfs(3)	0	T	0
check 5			
check 4			
3 done			
check 4			
check 0			
5 done			
check 6			
check 3			
4 done			
6 done			
dfs(2)	0	T	0
check 0			
2 done			
dfs(1)	0	T	0
check 0			
1 done			
check 5			
0 done			
dfs(7)	1	T	1
dfs(8)	1	T	1
check 7			
8 done			
7 done			
dfs(9)	2	T	2
dfs(11)	2	T	2
check 9			
dfs(12)	2	T	2
check 11			
check 9			
12 done			
11 done			
dfs(10)	2	T	2
check 9			
10 done			
check 12			
9 done			

Trace of depth-first search to find connected components

`connected()` in SECTION 1.5 (just check if identifiers are equal). In this case, the identifier 0 is assigned to all the vertices in the first component processed, 1 is assigned to all the vertices in the second component processed, and so forth, so that the identifiers are all between 0 and `count()-1`, as specified in the API. This convention enables the use of component-indexed arrays, as in the test client on page 543.

Proposition C. DFS uses preprocessing time and space proportional to $V+E$ to support constant-time connectivity queries in a graph.

Proof: Immediate from the code. Each adjacency-list entry is examined exactly once, and there are $2E$ such entries (two for each edge). Instance methods examine or return one or two instance variables.

Union-find. How does the DFS-based solution for graph connectivity in CC compare with the union-find approach of CHAPTER 1? In theory, DFS is faster than union-find because it provides a constant-time guarantee, which union-find does not; in practice, this difference is negligible, and union-find is faster because it does not have to build a full representation of the graph. More important, union-find is an online algorithm (we can check whether two vertices are connected in near-constant time at any point, even while adding edges), whereas the DFS solution must first preprocess the graph. Therefore, for example, we prefer union-find when determining connectivity is our only task or when we have a large number of queries intermixed with edge insertions but may find the DFS solution more appropriate for use in a graph ADT because it makes efficient use of existing infrastructure.

THE PROBLEMS THAT WE HAVE SOLVED with DFS are fundamental. It is a simple approach, and recursion provides us a way to reason about the computation and develop compact solutions to graph-processing problems. Two additional examples, for solving the following problems, are given in the table on the facing page.

Cycle detection. Support this query: *Is a given graph acyclic?*

Two-colorability. Support this query: *Can the vertices of a given graph be assigned one of two colors in such a way that no edge connects vertices of the same color?* which is equivalent to this question: *Is the graph bipartite?*

As usual with DFS, the simple code masks a more sophisticated computation, so studying these examples, tracing their behavior on small sample graphs, and extending them to provide a cycle or a coloring, respectively, are worthwhile (and left for exercises).

task	implementation
-------------	-----------------------

*is G acyclic?
(assumes
no self-loops or
parallel edges)*

```
public class Cycle
{
    private boolean[] marked;
    private boolean hasCycle;

    public Cycle(Graph G)
    {
        marked = new boolean[G.V()];
        for (int s = 0; s < G.V(); s++)
            if (!marked[s])
                dfs(G, s, s);
    }

    private void dfs(Graph G, int v, int u)
    {
        marked[v] = true;
        for (int w : G.adj(v))
            if (!marked[w])
                dfs(G, w, v);
            else if (w != u) hasCycle = true;
    }

    public boolean hasCycle()
    { return hasCycle; }
}
```

*is G bipartite?
(two-colorable)*

```
public class TwoColor
{
    private boolean[] marked;
    private boolean[] color;
    private boolean isTwoColorable = true;

    public TwoColor(Graph G)
    {
        marked = new boolean[G.V()];
        color = new boolean[G.V()];
        for (int s = 0; s < G.V(); s++)
            if (!marked[s])
                dfs(G, s);
    }

    private void dfs(Graph G, int v)
    {
        marked[v] = true;
        for (int w : G.adj(v))
            if (!marked[w])
            {
                color[w] = !color[v];
                dfs(G, w);
            }
            else if (color[w] == color[v]) isTwoColorable = false;
    }

    public boolean isBipartite()
    { return isTwoColorable; }
}
```

More examples of graph processing with DFS

Symbol graphs Typical applications involve processing graphs defined in files or on web pages, using strings, not integer indices, to define and refer to vertices. To accommodate such applications, we define an input format with the following properties:

- Vertex names are strings.
- A specified delimiter separates vertex names (to allow for the possibility of spaces in names).
- Each line represents a set of edges, connecting the first vertex name on the line to each of the other vertices named on the line.
- The number of vertices V and the number of edges E are both implicitly defined.

Shown below is a small example, the file `routes.txt`, which represents a model for a small transportation system where vertices are U.S. airport codes and edges connecting them are airline routes between the vertices. The file is simply a list of edges. Shown

`routes.txt`

```
JFK MCO
ORD DEN
ORD HOU
DFW PHX
JFK ATL
ORD DFW
ORD PHX
ATL HOU
DEN PHX
PHX LAX
JFK ORD
DEN LAS
DFW HOU
ORD ATL
LAS LAX
ATL MCO
HOU MCO
LAS PHX
```

*V and E
not explicitly
specified*

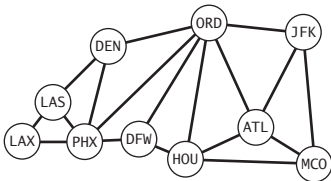

" " delimiter

Symbol graph example (list of edges)

on the facing page is a larger example, taken from the file `movies.txt`, from the *Internet Movie Database* (IMDB), that we introduced in SECTION 3.5. Recall that this file consists of lines listing a movie name followed by a list of the performers in the movie. In the context of graph processing, we can view it as defining a graph with movies and performers as vertices and each line defining the adjacency list of edges connecting each movie to its performers. Note that the graph is a *bipartite* graph—there are no edges connecting performers to performers or movies to movies.

API. The following API defines a Graph client that allows us to immediately use our graph-processing routines for graphs defined by such files:

```
public class SymbolGraph
```

```
    SymbolGraph(String filename,  
                String delim)
```

```
    boolean contains(String key)
```

```
    int index(String key)
```

```
    String name(int v)
```

```
    Graph G()
```

*build graph specified in
filename using delim to
separate vertex names*

is key a vertex?

index associated with key

key associated with index v

underlying Graph

API for graphs with symbolic vertex names

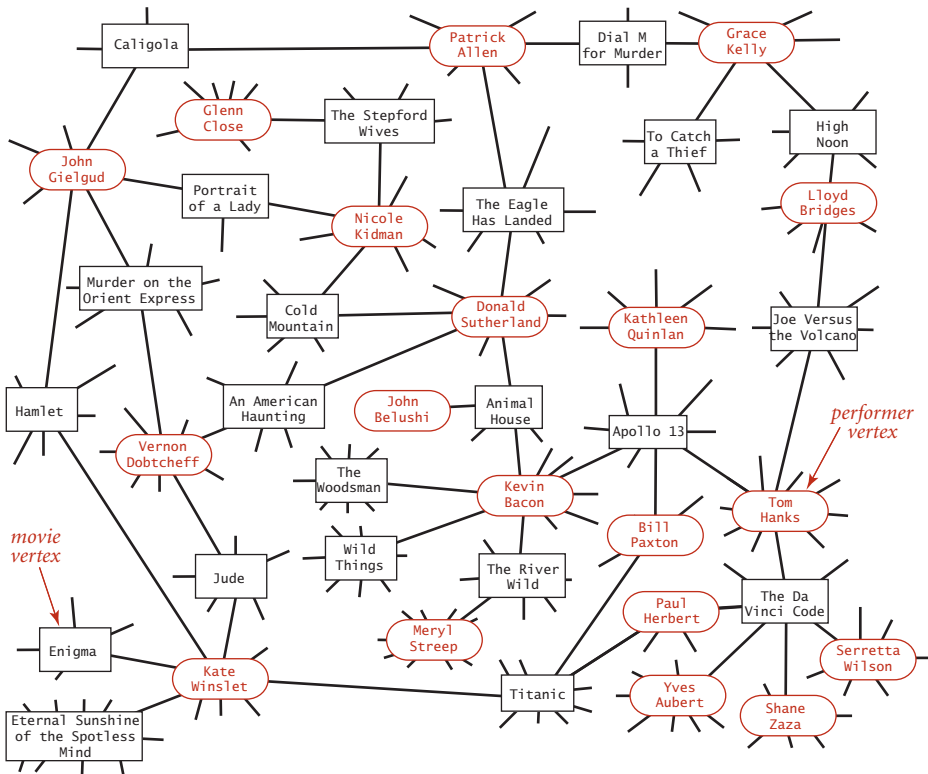

V and E not explicitly specified

movies.txt

...

Tin Men (1987)/DeBoy, David/Blumenfeld, Alan/... /Geppi, Cindy/Hershey, Barbara...

Tirez sur le pianiste (1960)/Heymann, Claude/.../Berger, Nicole (I)...

Titanic (1997)/Mazin, Stan/...DiCaprio, Leonardo/.../Winslet, Kate/...

Titus (1999)/Weisskopf, Hermann/Rhys, Matthew/.../McEwan, Geraldine

To Be or Not to Be (1942)/Verebes, Ernö (I)/.../Lombard, Carole (I)...

To Be or Not to Be (1983)/.../Brooks, Mel (I)/.../Bancroft, Anne/...

To Catch a Thief (1955)/Paris, Manuel/.../Grant, Cary/.../Kelly, Grace/...

To Die For (1995)/Smith, Kurtwood/.../Kidman, Nicole/.../ Tucci, Maria...

...

"/" delimiter

movie

performers

Symbol graph example (adjacency lists)

```

public static void main(String[] args)
{
    String filename = args[0];
    String delim = args[1];
    SymbolGraph sg = new SymbolGraph(filename, delim);

    Graph G = sg.G();

    while (StdIn.hasNextLine())
    {
        String source = StdIn.readLine();
        for (int w : G.adj(sg.index(source)))
            StdOut.println("    " + sg.name(w));
    }
}

```

Test client for symbol graph API

```

% java SymbolGraph routes.txt " "
JFK
    ORD
    ATL
    MCO
LAX
    LAS
    PHX

```

```

% java SymbolGraph movies.txt "/"
Tin Men (1987)
    DeBoy, David
    Blumenfeld, Alan
    ...
    Geppi, Cindy
    Hershey, Barbara
    ...
Bacon, Kevin
    Mystic River (2003)
    Friday the 13th (1980)
    Flatliners (1990)
    Few Good Men, A (1992)
    ...

```

This API provides a constructor to read and build the graph and client methods `name()` and `index()` for translating vertex names between the strings on the input stream and the integer indices used by our graph-processing methods.

Test client. The test client at left builds a graph from the file named as the first command-line argument (using the delimiter as specified by the second command-line argument)

and then takes queries from standard input. The user specifies a vertex name and gets the list of vertices adjacent to that vertex. This client immediately provides the useful inverted index functionality that we considered in SECTION 3.5. In the case of `routes.txt`, you can type an airport code to find the direct flights from that airport, information that is not directly available in the data file. In the case of `movies.txt`, you can type the name of a performer to see the list of the movies in the database in which that performer appeared, or you can type the name of a movie to see the list of performers that appear in that movie. Typing a movie name and getting its cast is not much more than regurgitating the corresponding line in the input file, but typing the name of a performer and getting the list of movies in which that performer has appeared is inverting the index. Even though the database is built around connecting movies to performers, the bipartite graph model embraces the idea that it also connects performers to movies. The bipartite graph model automatically serves as an inverted index and also provides the basis for more sophisticated processing, as we will see.

THIS APPROACH IS CLEARLY EFFECTIVE for any of the graph-processing methods that we consider: any client can use `index()` when it wants to convert a vertex name to an index for use in graph processing and `name()` when it wants to convert an index from graph processing into a name for use in the context of the application.

Implementation. A full `SymbolGraph` implementation is given on page 552. It builds three data structures:

- A symbol table `st` with `String` keys (vertex names) and `int` values (indices)
- An array `keys[]` that serves as an inverted index, giving the vertex name associated with each integer index
- A Graph `G` built using the indices to refer to vertices

`SymbolGraph` uses two passes through the data to build these data structures, primarily because the number of vertices V is needed to build the Graph. In typical real-world applications, keeping the value of V and E in the graph definition file (as in our Graph constructor at the beginning of this section) is somewhat inconvenient—with `SymbolGraph`, we can maintain files such as `routes.txt` or `movies.txt` by adding or deleting entries without regard to the number of different names involved.

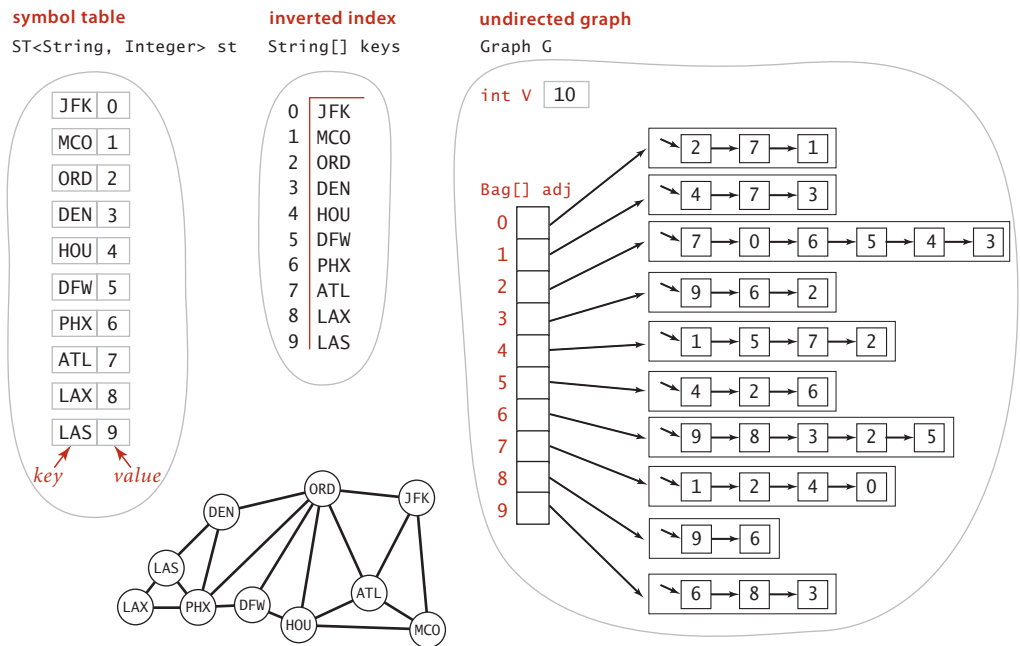

Symbol graph data structures

Symbol graph data type

```

public class SymbolGraph
{
    private ST<String, Integer> st;           // String -> index
    private String[] keys;                  // index -> String
    private Graph G;                       // the graph

    public SymbolGraph(String stream, String sp)
    {
        st = new ST<String, Integer>();
        In in = new In(stream);            // First pass
        while (in.hasNextLine())           // builds the index
        {
            String[] a = in.readLine().split(sp); // by reading strings
            for (int i = 0; i < a.length; i++) // to associate each
                if (!st.contains(a[i])) // distinct string
                    st.put(a[i], st.size()); // with an index.
        }
        keys = new String[st.size()];       // Inverted index
        for (String name : st.keys()) // to get string keys
            keys[st.get(name)] = name; // is an array.

        G = new Graph(st.size());
        in = new In(stream);                // Second pass
        while (in.hasNextLine())           // builds the graph
        {
            String[] a = in.readLine().split(sp); // by connecting the
            int v = st.get(a[0]); // first vertex
            for (int i = 1; i < a.length; i++) // on each line
                G.addEdge(v, st.get(a[i])); // to all the others.
        }
    }

    public boolean contains(String s) { return st.contains(s); }
    public int index(String s) { return st.get(s); }
    public String name(int v) { return keys[v]; }
    public Graph G() { return G; }
}

```

This Graph client allows clients to define graphs with String vertex names instead of integer indices. It maintains instance variables `st` (a symbol table that maps names to indices), `keys` (an array that maps indices to names), and `G` (a graph, with integer vertex names). To build these data structures, it makes two passes through the graph definition (each line has a string and a list of adjacent strings, separated by the delimiter `sp`).

Degrees of separation. One of the classic applications of graph processing is to find the degree of separation between two individuals in a social network. To fix ideas, we discuss this application in terms of a recently popularized pastime known as the *Kevin Bacon game*, which uses the movie-performer graph that we just considered. Kevin Bacon is a prolific actor who has appeared in many movies. We assign every performer a *Kevin Bacon number* as follows: Bacon himself is 0, any performer who has been in the same cast as Bacon has a Kevin Bacon number of 1, any other performer (except Bacon) who has been in the same cast as a performer whose number is 1 has a Kevin Bacon number of 2, and so forth. For example, Meryl Streep has a Kevin Bacon number of 1 because she appeared in *The River Wild* with Kevin Bacon. Nicole Kidman’s number is 2: although she did not appear in any movie with Kevin Bacon, she was in *Days of Thunder* with Tom Cruise, and Cruise appeared in *A Few Good Men* with Kevin Bacon. Given the name of a performer, the simplest version of the game is to find some alternating sequence of movies and performers that leads back to Kevin Bacon. For example, a movie buff might know that Tom Hanks was in *Joe Versus the Volcano* with Lloyd Bridges, who was in *High Noon* with Grace Kelly, who was in *Dial M for Murder* with Patrick Allen, who was in *The Eagle Has Landed* with Donald Sutherland, who was in *Animal House* with Kevin Bacon. But this knowledge does not suffice to establish Tom Hanks’s Bacon number (it is actually 1 because he was in *Apollo 13* with Kevin Bacon). You can see that the Kevin Bacon number has to

```
% java DegreesOfSeparation movies.txt "/" "Bacon, Kevin"
Kidman, Nicole
  Bacon, Kevin
  Few Good Men, A (1992)
  Cruise, Tom
  Days of Thunder (1990)
  Kidman, Nicole
Grant, Cary
  Bacon, Kevin
  Mystic River (2003)
  Willis, Susan
  Majestic, The (2001)
  Landau, Martin
  North by Northwest (1959)
  Grant, Cary
```

be defined by counting the movies in the *shortest* such sequence, so it is hard to be sure whether someone wins the game without using a computer. Of course, as illustrated in the `SymbolGraph` client `DegreesOfSeparation` on page 555, `BreadthFirstPaths` is the program we need to find a shortest path that establishes the Kevin Bacon number of any performer in `movies.txt`. This program takes a source vertex from the command line, then takes queries from standard input and prints a shortest path from the source to the query vertex. Since the graph associated with `movies.txt` is bipartite, all paths alternate between movies and performers, and the printed path is a “proof” that the path is valid (but not a proof that it is the shortest such path—you need to educate your

friends about PROPOSITION B for that). `DegreesOfSeparation` also finds shortest paths in graphs that are not bipartite: for example, it finds a way to get from one airport to another in `routes.txt` using the fewest connections.

YOU MIGHT ENJOY USING `DegreesOfSeparation` to answer some entertaining questions about the movie business. For example, you can find separations between movies, not just performers. More important, the concept of separation has been widely studied in many other contexts. For example, mathematicians play this same game with the graph defined by paper co-authorship and their connection to P. Erdős, a prolific 20th-century mathematician. Similarly, everyone in New Jersey seems to have a Bruce Springsteen number of 2, because everyone in the state seems to know someone who claims to know Bruce. To play the Erdős game, you would need a database of all mathematical papers; playing the Springsteen game is a bit more challenging. On a more serious note, degrees of separation play a crucial role in the design of computer and communications networks, and in our understanding of natural networks in all fields of science.

```
% java DegreesOfSeparation movies.txt "/" "Animal House (1978)"
Titanic (1997)
  Animal House (1978)
  Allen, Karen (I)
  Raiders of the Lost Ark (1981)
  Taylor, Rocky (I)
  Titanic (1997)
To Catch a Thief (1955)
  Animal House (1978)
  Vernon, John (I)
  Topaz (1969)
  Hitchcock, Alfred (I)
  To Catch a Thief (1955)
```

Degrees of separation

```

public class DegreesOfSeparation
{
    public static void main(String[] args)
    {
        SymbolGraph sg = new SymbolGraph(args[0], args[1]);
        Graph G = sg.G();
        String source = args[2];
        if (!sg.contains(source))
        { StdOut.println(source + " not in database."); return; }
        int s = sg.index(source);
        BreadthFirstPaths bfs = new BreadthFirstPaths(G, s);
        while (!StdIn.isEmpty())
        {
            String sink = StdIn.readLine();
            if (sg.contains(sink))
            {
                int t = sg.index(sink);
                if (bfs.hasPathTo(t))
                    for (int v : bfs.pathTo(t))
                        StdOut.println("  " + sg.name(v));
                else StdOut.println("Not connected");
            }
            else StdOut.println("Not in database.");
        }
    }
}

```

This `SymbolGraph` and `BreadthFirstPaths` client finds shortest paths in graphs. For `movies.txt`, it plays the Kevin Bacon game.

```

% java DegreesOfSeparation routes.txt " " JFK
LAS
  JFK
  ORD
  PHX
  LAS
DFW
  JFK
  ORD
  DFW

```

Summary In this section, we have introduced several basic concepts that we will expand upon and further develop throughout the rest of this chapter:

- Graph nomenclature
- A graph representation that enables processing of huge sparse graphs
- A design pattern for graph processing, where we implement algorithms by developing clients that preprocess the graph in the constructor, building data structures that can efficiently support client queries about the graph
- Depth-first search and breadth-first search
- A class providing the capability to use symbolic vertex names

The table below summarizes the implementations of graph algorithms that we have considered. These algorithms are a proper introduction to graph processing, since variants on their code will resurface as we consider more complicated types of graphs and applications, and (consequently) more difficult graph-processing problems. The same questions involving connections and paths among vertices become much more difficult when we add direction and then weights to graph edges, but the same approaches are effective in addressing them and serve as a starting point for addressing more difficult problems.

problem	solution	reference
<i>single-source connectivity</i>	DepthFirstSearch	page 531
<i>single-source paths</i>	DepthFirstPaths	page 536
<i>single-source shortest paths</i>	BreadthFirstPaths	page 540
<i>connectivity</i>	CC	page 544
<i>cycle detection</i>	Cycle	page 547
<i>two-colorability (bipartiteness)</i>	TwoColor	page 547

(Undirected) graph-processing problems addressed in this section

Q&A

Q. Why not jam all of the algorithms into `Graph.java`?

A. Yes, we might just add query methods (and whatever private fields and methods each might need) to the basic `Graph` ADT definition. While this approach has some of the virtues of data abstraction that we have embraced, it also has some serious drawbacks, because the world of graph processing is significantly more expansive than the kinds of basic data structures treated in SECTION 1.3. Chief among these drawbacks are the following:

- There are many more graph-processing operations to implement than we can accurately define in a single API.
- Simple graph-processing tasks have to use the same API needed by complicated tasks.
- One method can access a field intended for use by another method, contrary to encapsulation principles that we would like to follow.

This situation is not unusual: APIs of this kind have come to be known as *wide* interfaces (see page 97). In a chapter filled with graph-processing algorithms, an API of this sort would be wide indeed.

Q. Does `SymbolGraph` really need two passes?

A. No. You could pay an extra $\lg N$ factor and support `adj(C)` directly as an `ST` instead of a `Bag`. We have an implementation along these lines in our book *An Introduction to Programming in Java: An Interdisciplinary Approach*.

EXERCISES

4.1.1 What is the maximum number of edges in a graph with V vertices and no parallel edges? What is the minimum number of edges in a graph with V vertices, none of which are isolated?

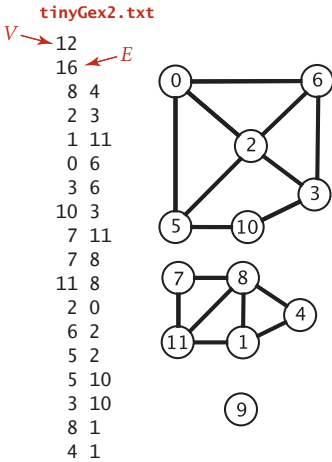

4.1.2 Draw, in the style of the figure in the text (page 524), the adjacency lists built by Graph's input stream constructor for the file `tinyGex2.txt` depicted at left.

4.1.3 Create a copy constructor for Graph that takes as input a graph G and creates and initializes a new copy of the graph. Any changes a client makes to G should not affect the newly created graph.

4.1.4 Add a method `hasEdge()` to Graph which takes two `int` arguments v and w and returns `true` if the graph has an edge $v-w$, `false` otherwise.

4.1.5 Modify Graph to disallow parallel edges and self-loops.

4.1.6 Consider the four-vertex graph with edges $0-1$, $1-2$, $2-3$, and $3-0$. Draw an array of adjacency-lists that could *not* have been built calling `addEdge()` for these edges *no matter what order*.

4.1.7 Develop a test client for Graph that reads a graph from the input stream named as command-line argument and then prints it, relying on `toString()`.

4.1.8 Develop an implementation for the Search API on page 528 that uses UF, as described in the text.

4.1.9 Show, in the style of the figure on page 533, a detailed trace of the call `dfs(0)` for the graph built by Graph's input stream constructor for the file `tinyGex2.txt` (see EXERCISE 4.1.2). Also, draw the tree represented by `edgeTo[]`.

4.1.10 Prove that every connected graph has a vertex whose removal (including all adjacent edges) will not disconnect the graph, and write a DFS method that finds such a vertex. *Hint*: Consider a vertex whose adjacent vertices are all marked.

4.1.11 Draw the tree represented by `edgeTo[]` after the call `bfs(G, 0)` in ALGORITHM 4.2 for the graph built by Graph's input stream constructor for the file `tinyGex2.txt` (see EXERCISE 4.1.2).

4.1.12 What does the BFS tree tell us about the distance from v to w when neither is at the root?

4.1.13 Add a `distTo()` method to the `BreadthFirstPaths` API and implementation, which returns the number of edges on the shortest path from the source to a given vertex. A `distTo()` query should run in constant time.

4.1.14 Suppose you use a stack instead of a queue when running breadth-first search. Does it still compute shortest paths?

4.1.15 Modify the input stream constructor for `Graph` to also allow adjacency lists from standard input (in a manner similar to `SymbolGraph`), as in the example `tinyGadj.txt` shown at right. After the number of vertices and edges, each line contains a vertex and its list of adjacent vertices.

4.1.16 The *eccentricity* of a vertex v is the length of the shortest path from that vertex to the furthest vertex from v . The *diameter* of a graph is the maximum eccentricity of any vertex. The *radius* of a graph is the smallest eccentricity of any vertex. A *center* is a vertex whose eccentricity is the radius. Implement the following API:

```
public class GraphProperties
```

```

    GraphProperties(Graph G)  constructor (exception if G not connected)
    int eccentricity(int v)   eccentricity of v
    int diameter()           diameter of G
    int radius()             radius of G
    int center()             a center of G

```

4.1.18 The *girth* of a graph is the length of its shortest cycle. If a graph is acyclic, then its girth is infinite. Add a method `girth()` to `GraphProperties` that returns the girth of the graph. *Hint*: Run BFS from each vertex. The shortest cycle containing s is a shortest path from s to some vertex v , plus the edge from v back to s .

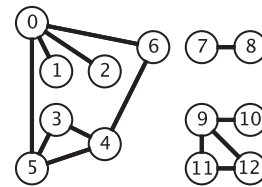

`tinyGadj.txt`

```

V → 13
    13 ← E
    0 1 2 5 6
    3 4 5
    4 5 6
    7 8
    9 10 11 12
    11 12

```

```

% java Graph tinyGadj.txt
13 vertices, 13 edges
0: 6 5 2 1
1: 0
2: 0
3: 5 4
4: 6 5 3
5: 4 3 0
6: 4 0
7: 8
8: 7
9: 12 11 10
10: 9
11: 12 9
12: 11 9

```

same lists as for list-of-edges input but order within lists is different

list order is reversed from input

second representation of each edge appears in red

EXERCISES *(continued)*

4.1.19 Show, in the style of the figure on page 545, a detailed trace of `CC` for finding the connected components in the graph built by `Graph`'s input stream constructor for the file `tinyGex2.txt` (see EXERCISE 4.1.2).

4.1.20 Show, in the style of the figures in this section, a detailed trace of `Cycle` for finding a cycle in the graph built by `Graph`'s input stream constructor for the file `tinyGex2.txt` (see EXERCISE 4.1.2). What is the order of growth of the running time of the `Cycle` constructor, in the worst case?

4.1.21 Show, in the style of the figures in this section, a detailed trace of `TwoColor` for finding a two-coloring of the graph built by `Graph`'s input stream constructor for the file `tinyGex2.txt` (see EXERCISE 4.1.2). What is the order of growth of the running time of the `TwoColor` constructor, in the worst case?

4.1.22 Run `SymbolGraph` with `movies.txt` to find the Kevin Bacon number of this year's Oscar nominees.

4.1.23 Write a program `BaconHistogram` that prints a histogram of Kevin Bacon numbers, indicating how many performers from `movies.txt` have a Bacon number of 0, 1, 2, 3, Include a category for those who have an infinite number (not connected to Kevin Bacon).

4.1.24 Compute the number of connected components in `movies.txt`, the size of the largest component, and the number of components of size less than 10. Find the eccentricity, diameter, radius, a center, and the girth of the largest component in the graph. Does it contain Kevin Bacon?

4.1.25 Modify `DegreesOfSeparation` to take an `int` value `y` as a command-line argument and ignore movies that are more than `y` years old.

4.1.26 Write a `SymbolGraph` client like `DegreesOfSeparation` that uses *depth-first* search instead of *breadth-first* search to find paths connecting two performers, producing output like that shown on the facing page.

4.1.27 Determine the amount of memory used by Graph to represent a graph with V vertices and E edges, using the memory-cost model of SECTION 1.4.

4.1.28 Two graphs are *isomorphic* if there is a way to rename the vertices of one to make it identical to the other. Draw all the nonisomorphic graphs with two, three, four, and five vertices.

4.1.29 Modify Cycle so that it works even if the graph contains self-loops and parallel edges.

```
% java DegreesOfSeparationDFS movies.txt
Source: Bacon, Kevin
Query: Kidman, Nicole
  Bacon, Kevin
  Mystic River (2003)
  O'Hara, Jenny
  Matchstick Men (2003)
  Grant, Beth
... [123 movies] (!)
  Law, Jude
  Sky Captain... (2004)
  Jolie, Angelina
  Playing by Heart (1998)
  Anderson, Gillian (I)
  Cock and Bull Story, A (2005)
  Henderson, Shirley (I)
  24 Hour Party People (2002)
  Eccleston, Christopher
  Gone in Sixty Seconds (2000)
  Balahoutis, Alexandra
  Days of Thunder (1990)
  Kidman, Nicole
```

CREATIVE PROBLEMS

4.1.30 *Eulerian and Hamiltonian cycles.* Consider the graphs defined by the following four sets of edges:

```

0-1 0-2 0-3 1-3 1-4 2-5 2-9 3-6 4-7 4-8 5-8 5-9 6-7 6-9 7-8
0-1 0-2 0-3 1-3 0-3 2-5 5-6 3-6 4-7 4-8 5-8 5-9 6-7 6-9 8-8
0-1 1-2 1-3 0-3 0-4 2-5 2-9 3-6 4-7 4-8 5-8 5-9 6-7 6-9 7-8
4-1 7-9 6-2 7-3 5-0 0-2 0-8 1-6 3-9 6-3 2-8 1-5 9-8 4-5 4-7

```

Which of these graphs have Euler cycles (cycles that visit each edge exactly once)? Which of them have Hamilton cycles (cycles that visit each vertex exactly once)?

4.1.31 *Graph enumeration.* How many different undirected graphs are there with V vertices and E edges (and no parallel edges)?

4.1.32 *Parallel edge detection.* Devise a linear-time algorithm to count the parallel edges in a graph.

4.1.33 *Odd cycles.* Prove that a graph is two-colorable (bipartite) if and only if it contains no odd-length cycle.

4.1.34 *Symbol graph.* Implement a one-pass `SymbolGraph` (it need not be a `Graph` client). Your implementation may pay an extra $\log V$ factor for graph operations, for symbol-table lookups.

4.1.35 *Biconnectedness.* A graph is *biconnected* if every pair of vertices is connected by two disjoint paths. An *articulation point* in a connected graph is a vertex that would disconnect the graph if it (and its adjacent edges) were removed. Prove that any graph with no articulation points is biconnected. *Hint:* Given a pair of vertices s and t and a path connecting them, use the fact that none of the vertices on the path are articulation points to construct two disjoint paths connecting s and t .

4.1.36 *Edge connectivity.* A *bridge* in a graph is an edge that, if removed, would separate a connected graph into two disjoint subgraphs. A graph that has no bridges is said to be *edge connected*. Develop a DFS-based data type for determining whether a given graph is edge connected.

4.1.37 *Euclidean graphs.* Design and implement an API `EuclideanGraph` for graphs whose vertices are points in the plane that include coordinates. Include a method `show()` that uses `StdDraw` to draw the graph.

4.1.38 *Image processing.* Implement the *flood fill* operation on the implicit graph defined by connecting adjacent points that have the same color in an image.

EXPERIMENTS

4.1.39 *Random graphs.* Write a program `ErdosRenyiGraph` that takes integer values V and E from the command line and builds a graph by generating E random pairs of integers between 0 and $V-1$. *Note:* This generator produces self-loops and parallel edges.

4.1.40 *Random simple graphs.* Write a program `RandomSimpleGraph` that takes integer values V and E from the command line and produces, with equal likelihood, each of the possible *simple* graphs with V vertices and E edges.

4.1.41 *Random sparse graphs.* Write a program `RandomSparseGraph` to generate random sparse graphs for a well-chosen set of values of V and E such that you can use it to run meaningful empirical tests on graphs drawn from the Erdős-Renyi model.

4.1.42 *Random Euclidean graphs.* Write a `EuclideanGraph` client (see EXERCISE 4.1.37) `RandomEuclideanGraph` that produces random graphs by generating V random points in the plane, then connecting each point with all points that are within a circle of radius d centered at that point. *Note:* The graph will almost certainly be connected if d is larger than the threshold value $\sqrt{\lg V/\pi V}$ and almost certainly disconnected if d is smaller than that value.

4.1.43 *Random grid graphs.* Write a `EuclideanGraph` client `RandomGridGraph` that generates random graphs by connecting vertices arranged in a \sqrt{V} -by- \sqrt{V} grid to their neighbors (see EXERCISE 1.5.15). Augment your program to add R extra random edges. For large R , shrink the grid so that the total number of edges remains about V . Add an option such that an extra edge goes from a vertex s to a vertex t with probability inversely proportional to the Euclidean distance between s and t .

4.1.44 *Real-world graphs.* Find a large weighted graph on the web—perhaps a map with distances, telephone connections with costs, or an airline rate schedule. Write a program `RandomRealGraph` that builds a graph by choosing V vertices at random and E edges at random from the subgraph induced by those vertices.

4.1.45 *Random interval graphs.* Consider a collection of V intervals on the real line (pairs of real numbers). Such a collection defines an *interval graph* with one vertex corresponding to each interval, with edges between vertices if the corresponding intervals intersect (have any points in common). Write a program that generates V random intervals in the unit interval, all of length d , then builds the corresponding interval graph. *Hint:* Use a BST.

4.1.46 *Random transportation graphs.* One way to define a transportation system is with a set of sequences of vertices, each sequence defining a path connecting the vertices. For example, the sequence 0-9-3-2 defines the edges 0-9, 9-3, and 3-2. Write a `EuclideanGraph` client `RandomTransportation` that builds a graph from an input file consisting of one sequence per line, using symbolic names. Develop input suitable to allow you to use your program to build a graph corresponding to the Paris Métro system.

Testing all algorithms and studying all parameters against all graph models is unrealistic. For each problem listed below, write a client that addresses the problem for any given input graph, then choose among the generators above to run experiments for that graph model. Use your judgment in selecting experiments, perhaps in response to results of previous experiments. Write a narrative explaining your results and any conclusions that might be drawn.

4.1.47 *Path lengths in DFS.* Run experiments to determine empirically the probability that `DepthFirstPaths` finds a path between two randomly chosen vertices and to calculate the average length of the paths found, for various graph models.

4.1.48 *Path lengths in BFS.* Run experiments to determine empirically the probability that `BreadthFirstPaths` finds a path between two randomly chosen vertices and to calculate the average length of the paths found, for various graph models.

4.1.49 *Connected components.* Run experiments to determine empirically the distribution of the number of components in random graphs of various types, by generating large numbers of graphs and drawing a histogram.

4.1.50 *Two-colorable.* Most graphs are not two-colorable, and DFS tends to discover that fact quickly. Run empirical tests to study the number of edges examined by `TwoColor`, for various graph models.

4.2 DIRECTED GRAPHS

In *directed graphs*, edges are one-way: the pair of vertices that defines each edge is an ordered pair that specifies a one-way adjacency. Many applications (for example, graphs that represent the web, scheduling constraints, or telephone calls) are naturally

expressed in terms of directed graphs. The one-way restriction is natural, easy to enforce in our implementations, and seems innocuous; but it implies added combinatorial structure that has profound implications for our algorithms and makes working with directed graphs quite different from working with undirected graphs. In this section, we consider classic algorithms for exploring and processing directed graphs.

application	vertex	edge
<i>food web</i>	species	predator-prey
<i>internet content</i>	page	hyperlink
<i>program</i>	module	external reference
<i>cellphone</i>	phone	call
<i>scholarship</i>	paper	citation
<i>financial</i>	stock	transaction
<i>internet</i>	machine	connection

Typical digraph applications

are worth restating. The slight differences in the wording to account for edge directions imply structural properties that will be the focus of this section.

Glossary Our definitions for directed graphs are nearly identical to those for undirected graphs (as are some of the algorithms and programs that we use), but they

Definition. A *directed graph* (or *digraph*) is a set of *vertices* and a collection of *directed edges*. Each directed edge connects an ordered pair of vertices.

We say that a directed edge *points from* the first vertex in the pair and *points to* the second vertex in the pair. The *outdegree* of a vertex in a digraph is the number of edges going *from* it; the *indegree* of a vertex is the number of edges going *to* it. We drop the modifier *directed* when referring to edges in digraphs when the distinction is obvious in context. The first vertex in a directed edge is called its *head*; the second vertex is called its *tail*. We draw directed edges as arrows pointing from head to tail. We use the notation $v \rightarrow w$ to refer to an edge that points from v to w in a digraph. As with undirected graphs, our code handles parallel edges and self-loops, but they are not present in examples and we generally ignore them in the text. Ignoring anomalies, there are four

different ways in which two vertices might be related in a digraph: no edge; an edge $v \rightarrow w$ from v to w ; an edge $w \rightarrow v$ from w to v ; or two edges $v \rightarrow w$ and $w \rightarrow v$, which indicate connections in both directions.

Definition. A *directed path* in a digraph is a sequence of vertices in which there is a (directed) edge pointing from each vertex in the sequence to its successor in the sequence. A *directed cycle* is a directed path with at least one edge whose first and last vertices are the same. A *simple cycle* is a cycle with no repeated edges or vertices (except the requisite repetition of the first and last vertices). The *length* of a path or a cycle is its number of edges.

As for undirected graphs, we assume that directed paths are simple unless we specifically relax this assumption by referring to specific repeated vertices (as in our definition of directed cycle) or to *general* directed paths. We say that a vertex w is *reachable* from a vertex v if there is a directed path from v to w . Also, we adopt the convention that each vertex is reachable from itself. Except for this case, the fact that w is reachable from v in a digraph indicates nothing about whether v is reachable from w . This distinction is obvious, but critical, as we shall see.

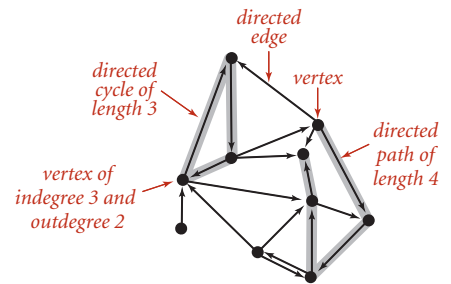

Anatomy of a digraph

UNDERSTANDING THE ALGORITHMS in this section requires an appreciation of the distinction between reachability in digraphs and connectivity in undirected graphs. Developing such an appreciation is more complicated than you might think. For example,

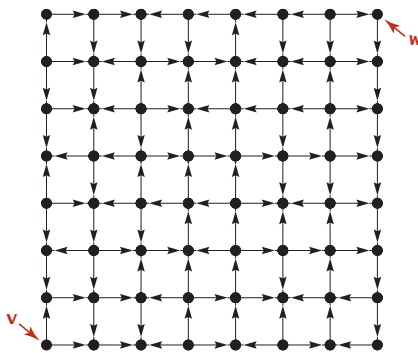

Is w reachable from v in this digraph?

although you are likely to be able to tell at a glance whether two vertices in a small undirected graph are connected, a directed path in a digraph is not so easy to spot, as indicated in the example at left. Processing digraphs is akin to traveling around in a city where all the streets are one-way, with the directions not necessarily assigned in any uniform pattern. Getting from one point to another in such a situation could be a challenge indeed. Counter to this intuition is the fact that the standard data structure that we use for representing digraphs is *simpler* than the corresponding representation for undirected graphs!

Digraph data type The API below and the class `Digraph` shown on the facing page are virtually identical to those for `Graph` (page 526).

<code>public class Digraph</code>		
<code>Digraph(int V)</code>		<i>create a V-vertex digraph with no edges</i>
<code>Digraph(In in)</code>		<i>read a digraph from input stream in</i>
<code>int V()</code>		<i>number of vertices</i>
<code>int E()</code>		<i>number of edges</i>
<code>void addEdge(int v, int w)</code>		<i>add edge v->w to this digraph</i>
<code>Iterable<Integer> adj(int v)</code>		<i>vertices connected to v by edges pointing from v</i>
<code>Digraph reverse()</code>		<i>reverse of this digraph</i>
<code>String toString()</code>		<i>string representation</i>

API for a digraph

Representation. We use the adjacency-lists representation, where an edge $v \rightarrow w$ is represented as a list node containing w in the linked list corresponding to v . This representation is essentially the same as for undirected graphs but is even more straightforward because each edge occurs just once, as shown on the facing page.

Input format. The code for the constructor that takes a digraph from an input stream is identical to the corresponding constructor in `Graph`—the input format is the same, but all edges are interpreted to be directed edges. In the list-of-edges format, a pair $v w$ is interpreted as an edge $v \rightarrow w$.

Reversing a digraph. `Digraph` also adds to the API a method `reverse()` which returns a copy of the digraph, with all edges reversed. This method is sometimes needed in digraph processing because it allows clients to find the edges that point *to* each vertex, while `adj()` gives just vertices connected by edges that point *from* each vertex.

Symbolic names. It is also a simple matter to allow clients to use symbolic names in digraph applications. To implement a class `SymbolDigraph` like `SymbolGraph` on page 552, replace `Graph` by `Digraph` everywhere.

IT IS WORTHWHILE to take the time to consider carefully the difference, by comparing code and the figure at right with their counterparts for undirected graphs on page 524 and page 526. In the adjacency-lists representation of an undirected graph, we know that if v is on w 's list, then w will be on v 's list; the adjacency-lists representation of a digraph has no such symmetry. This difference has profound implications in processing digraphs.

Directed graph (digraph) data type

```

public class Digraph
{
    private final int V;
    private int E;
    private Bag<Integer>[] adj;

    public Digraph(int V)
    {
        this.V = V;
        this.E = 0;
        adj = (Bag<Integer>[]) new Bag[V];
        for (int v = 0; v < V; v++)
            adj[v] = new Bag<Integer>();
    }

    public int V() { return V; }
    public int E() { return E; }

    public void addEdge(int v, int w)
    {
        adj[v].add(w);
        E++;
    }

    public Iterable<Integer> adj(int v)
    { return adj[v]; }

    public Digraph reverse()
    {
        Digraph R = new Digraph(V);
        for (int v = 0; v < V; v++)
            for (int w : adj(v))
                R.addEdge(w, v);
        return R;
    }
}

```

This Digraph data type is identical to Graph (page 526) except that `addEdge()` only calls `add()` once, and it has an instance method `reverse()` that returns a copy with all its edges reversed. Since the code is easily derived from the corresponding code for Graph, we omit the `toString()` method (see the table on page 523) and the input stream constructor from (see page 526).

tinyDG.txt

```

V → 13
22 ← E
4 2
2 3
3 2
6 0
0 1
2 0
11 12
12 9
9 10
9 11
8 9
10 12
11 4
4 3
3 5
7 8
8 7
5 4
0 5
6 4
6 9
7 6

```

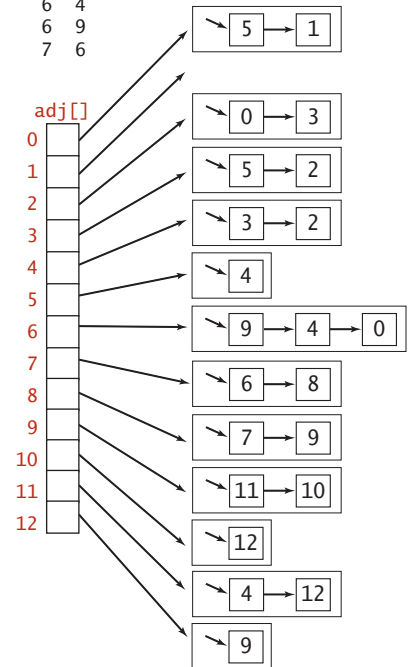
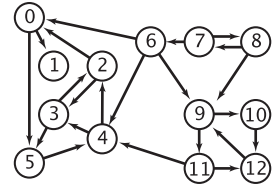

Digraph input format and adjacency-lists representation

Reachability in digraphs Our first graph-processing algorithm for undirected graphs was `DepthFirstSearch` on page 531, which solves the single-source connectivity problem, allowing clients to determine which vertices are connected to a given source. The *identical code* with `Graph` changed to `Digraph` solves the analogous problem for digraphs:

Single-source reachability. Given a digraph and a source vertex s , support queries of the form *Is there a directed path from s to a given target vertex v ?*

`DirectedDFS` on the facing page is a slight embellishment of `DepthFirstSearch` that implements the following API:

```
public class DirectedDFS
    DirectedDFS(Digraph G, int s)           find vertices in G that are
                                           reachable from s
    DirectedDFS(Digraph G,
                Iterable<Integer> sources) find vertices in G that are
                                           reachable from sources
    boolean marked(int v)                 is v reachable?
```

API for reachability in digraphs

By adding a second constructor that takes a list of vertices, this API supports for clients the following generalization of the problem:

Multiple-source reachability. Given a digraph and a *set* of source vertices, support queries of the form *Is there a directed path from any vertex in the set to a given target vertex v ?*

This problem arises in the solution of a classic string-processing problem that we consider in SECTION 5.4.

`DirectedDFS` uses our standard graph-processing paradigm and a standard recursive depth-first search to solve these problems. It calls the recursive `dfs()` for each source, which marks every vertex encountered.

Proposition D. DFS marks all the vertices in a digraph reachable from a given set of sources in time proportional to the sum of the outdegrees of the vertices marked.

Proof: Same as PROPOSITION A on page 531.

A trace of the operation of this algorithm for our sample digraph appears on page 572. This trace is somewhat simpler than the corresponding trace for undirected graphs,

ALGORITHM 4.4 Reachability in digraphs

```

public class DirectedDFS
{
    private boolean[] marked;

    public DirectedDFS(Digraph G, int s)
    {
        marked = new boolean[G.V()];
        dfs(G, s);
    }

    public DirectedDFS(Digraph G, Iterable<Integer> sources)
    {
        marked = new boolean[G.V()];
        for (int s : sources)
            if (!marked[s]) dfs(G, s);
    }

    private void dfs(Digraph G, int v)
    {
        marked[v] = true;
        for (int w : G.adj(v))
            if (!marked[w]) dfs(G, w);
    }

    public boolean marked(int v)
    { return marked[v]; }

    public static void main(String[] args)
    {
        Digraph G = new Digraph(new In(args[0]));
        Bag<Integer> sources = new Bag<Integer>();
        for (int i = 1; i < args.length; i++)
            sources.add(Integer.parseInt(args[i]));

        DirectedDFS reachable = new DirectedDFS(G, sources);

        for (int v = 0; v < G.V(); v++)
            if (reachable.marked(v)) StdOut.print(v + " ");
            StdOut.println();
    }
}

```

```
% java DirectedDFS tinyDG.txt 1
1
```

```
% java DirectedDFS tinyDG.txt 2
0 1 2 3 4 5
```

```
% java DirectedDFS tinyDG.txt 1 2 6
0 1 2 3 4 5 6 9 10 11 12
```

This implementation of depth-first search provides clients the ability to test which vertices are reachable from a given vertex or a given set of vertices.

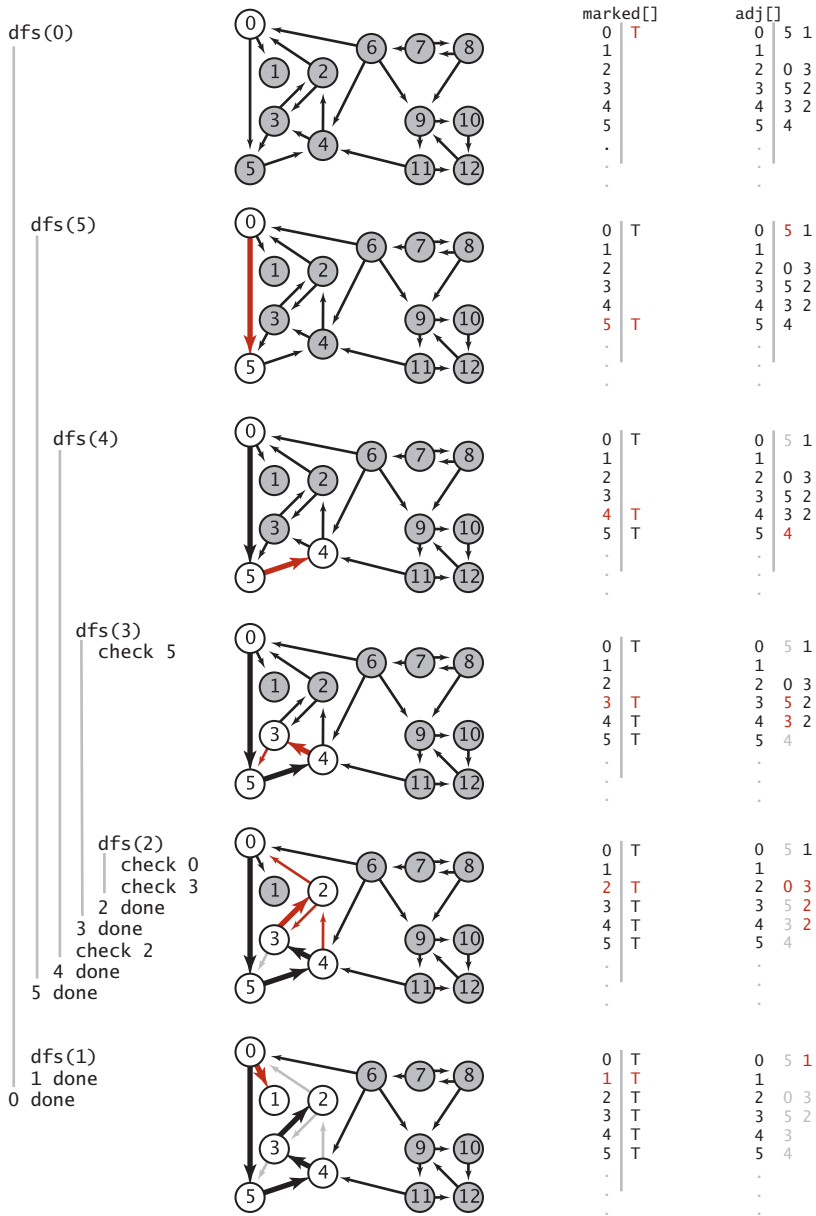

Trace of depth-first search to find vertices reachable from vertex 0 in a digraph

because DFS is fundamentally a digraph-processing algorithm, with one representation of each edge. Following this trace is a worthwhile way to help cement your understanding of depth-first search in digraphs.

Mark-and-sweep garbage collection. An important application of multiple-source reachability is found in typical memory-management systems, including many implementations of Java. A digraph where each vertex represents an object and each edge represents a reference to an object is an appropriate model for the memory usage of a running Java program. At any point in the execution of a program, certain objects are known to be directly accessible, and any object not reachable from that set of objects can be returned to available memory. A mark-and-sweep garbage collection strategy reserves one bit per object for the purpose of garbage collection, then periodically *marks* the set of potentially accessible objects by running a digraph reachability algorithm like `DirectedDFS` and *sweeps* through all objects, collecting the unmarked ones for use for new objects.

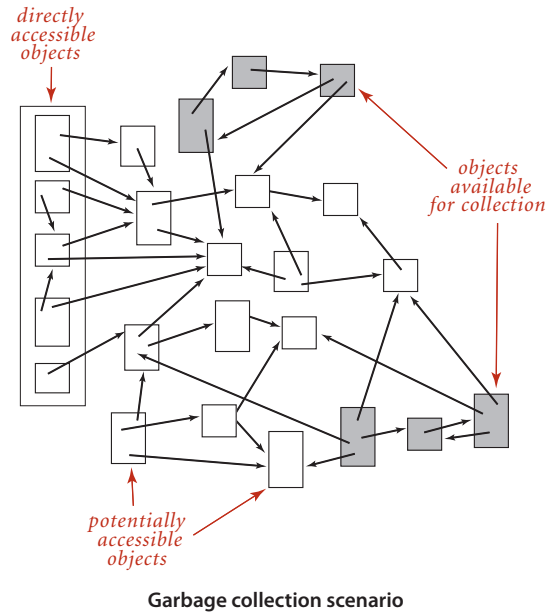

Finding paths in digraphs. `DepthFirstPaths` (ALGORITHM 4.1 on page 536) and `BreadthFirstPaths` (ALGORITHM 4.2 on page 540) are also fundamentally digraph-processing algorithms. Again, the identical APIs and code (with `Graph` changed to `Digraph`) effectively solve the following problems:

Single-source directed paths. Given a digraph and a source vertex s , support queries of the form *Is there a directed path from s to a given target vertex v ?* If so, find such a path.

Single-source shortest directed paths. Given a digraph and a source vertex s , support queries of the form *Is there a directed path from s to a given target vertex v ?* If so, find a *shortest* such path (one with a minimal number of edges).

On the booksite and in the exercises at the end of this section, we refer to these solutions as `DepthFirstDirectedPaths` and `BreadthFirstDirectedPaths`, respectively.

Cycles and DAGs Directed cycles are of particular importance in applications that involve processing digraphs. Identifying directed cycles in a typical digraph can be a challenge without the help of a computer, as shown at right. In principle, a digraph might have a huge number of cycles; in practice, we typically focus on a small number of them, or simply are interested in knowing that none are present.

To motivate the study of the role of directed cycles in digraph processing we consider, as a running example, the following prototypical application where digraph models arise directly:

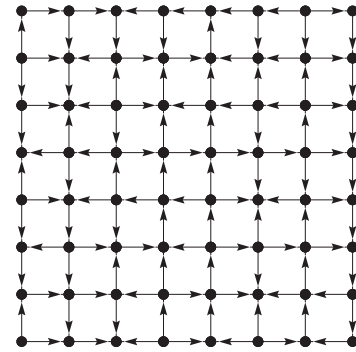

Does this digraph have a directed cycle?

Scheduling problems. A widely applicable problem-solving model has to do with arranging for the completion of a set of jobs, under a set of constraints, by specifying when and how the jobs are to be performed. Constraints might involve functions of the time taken or other resources consumed by the jobs. The most important type of constraints is *precedence constraints*, which specify that certain tasks must be performed before certain others. Different types of additional constraints lead to many different types of scheduling problems, of varying difficulty. Literally thousands of different problems have been studied, and researchers still seek better algorithms for many of them. As an example, consider a college student planning a course schedule, under the constraint that certain courses are prerequisite for certain other courses, as in the example below.

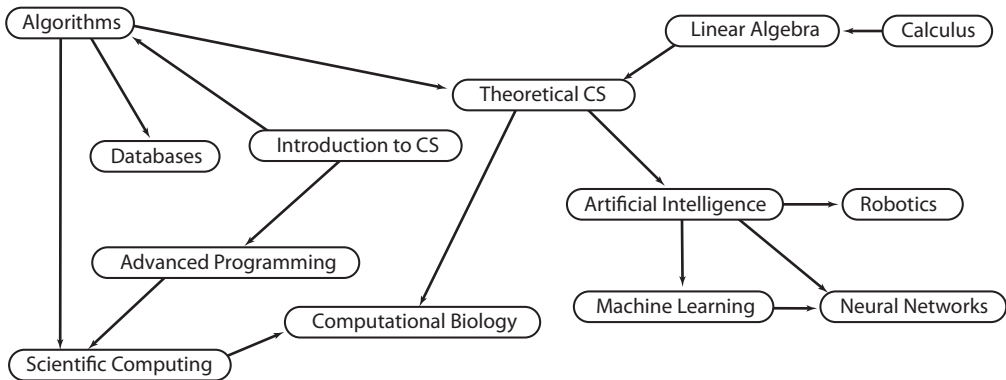

A precedence-constrained scheduling problem

If we further assume that the student can take only one course at a time, we have an instance of the following problem:

Precedence-constrained scheduling. Given a set of jobs to be completed, with precedence constraints that specify that certain jobs have to be completed before certain other jobs are begun, how can we schedule the jobs such that they are all completed while still respecting the constraints?

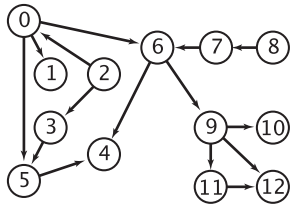

Standard digraph model

For any such problem, a digraph model is immediate, with vertices corresponding to jobs and directed edges corresponding to precedence constraints. For economy, we switch the example to our standard model with vertices labeled as integers, as shown at left. In digraphs, precedence-constrained scheduling amounts to the following fundamental problem:

Topological sort. Given a digraph, put the vertices in order such that all its directed edges point from a vertex earlier in the order to a vertex later in the order (or report that doing so is not possible).

A topological order for our example model is shown at right. All edges point down, so it clearly represents a solution to the precedence-constrained scheduling problem that this digraph models: the student can satisfy all course prerequisites by taking the courses in this order. This application is typical—some other representative applications are listed in the table below.

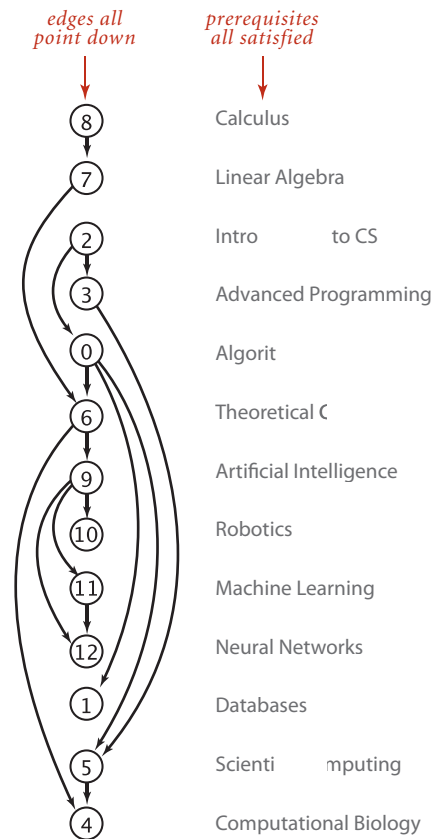

Topological sort

application	vertex	edge
<i>job schedule</i>	job	precedence constraint
<i>course schedule</i>	course	prerequisite
<i>inheritance</i>	Java class	extends
<i>spreadsheet</i>	cell	formula
<i>symbolic links</i>	file name	link

Typical topological-sort applications

Cycles in digraphs. If job x must be completed before job y , job y before job z , and job z before job x , then someone has made a mistake, because those three constraints cannot all be satisfied. In general, if a precedence-constrained scheduling problem has a directed cycle, then there is no feasible solution. To check for such errors, we need to be able to solve the following problem:

Directed cycle detection. Does a given digraph have a directed cycle? If so, find the vertices on some such cycle, in order from some vertex back to itself.

A graph may have an exponential number of cycles (see EXERCISE 4.2.11) so we only ask for one cycle, not all of them. For job scheduling and many other applications it is *required* that no directed cycle exists, so digraphs where they are absent play a special role:

Definition. A *directed acyclic graph* (DAG) is a digraph with no directed cycles.

Solving the directed cycle detection problem thus answers the following question: *Is a given digraph a DAG?* Developing a depth-first-search-based solution to this problem is not difficult, based on the fact that the recursive call stack maintained by the system represents the “current” directed path under consideration (like the string back to the entrance in Tremaux maze exploration). If we ever find a directed edge $v \rightarrow w$ to a vertex w that is on that stack, we have found a cycle, since the stack is evidence of a directed path from w to v , and the edge $v \rightarrow w$ completes the cycle. Moreover, the absence of any such *back edges* implies that the graph is acyclic. DirectedCycle on the facing page uses this idea to implement the following API:

```
public class DirectedCycle
    DirectedCycle(Digraph G)    cycle-finding constructor
    boolean hasCycle()         does G have a directed cycle?
    Iterable<Integer> cycle()  vertices on a cycle (if one exists)
```

API for reachability in digraphs

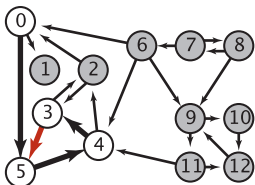

	marked[]	edgeTo[]	onStack[]
	0 1 2 3 4 5 ...	0 1 2 3 4 5 ...	0 1 2 3 4 5 ...
dfs(0)	0 0 0 0 0 0	- - - - -	0 0 0 0 0 0
dfs(5)	1 0 0 0 0 0	- - - - -	1 0 0 0 0 0
dfs(4)	1 0 0 0 0 1	- - - - 5	1 0 0 0 0 1
dfs(3)	1 0 0 0 1 1	- - - 4 5 0	1 0 0 0 1 1
check 5	1 0 0 1 1 1	- - - 4 5 0	1 0 0 1 1 1

Finding a directed cycle in a digraph

Finding a directed cycle

```

public class DirectedCycle
{
    private boolean[] marked;
    private int[] edgeTo;
    private Stack<Integer> cycle; // vertices on a cycle (if one exists)
    private boolean[] onStack; // vertices on recursive call stack

    public DirectedCycle(Digraph G)
    {
        onStack = new boolean[G.V()];
        edgeTo = new int[G.V()];
        marked = new boolean[G.V()];
        for (int v = 0; v < G.V(); v++)
            if (!marked[v]) dfs(G, v);
    }

    private void dfs(Digraph G, int v)
    {
        onStack[v] = true;
        marked[v] = true;
        for (int w : G.adj(v))
            if (this.hasCycle()) return;
            else if (!marked[w])
                { edgeTo[w] = v; dfs(G, w); }
            else if (onStack[w])
                {
                    cycle = new Stack<Integer>();
                    for (int x = v; x != w; x = edgeTo[x])
                        cycle.push(x);
                    cycle.push(w);
                    cycle.push(v);
                }
        onStack[v] = false;
    }

    public boolean hasCycle()
    { return cycle != null; }

    public Iterable<Integer> cycle()
    { return cycle; }
}

```

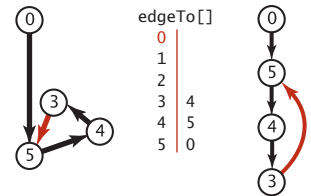

v	w	x	cycle
3	5	3	3
3	5	4	4 3
3	5	4	5 4 3
3	5	4	3 5 4 3

Trace of cycle computation

This class adds to our standard recursive `dfs()` a boolean array `onStack[]` to keep track of the vertices for which the recursive call has not completed. When it finds an edge $v \rightarrow w$ to a vertex w that is on the stack, it has discovered a directed cycle, which it can recover by following `edgeTo[]` links.

When executing `dfs(G, v)`, we have followed a directed path from the source to `v`. To keep track of this path, `DirectedCycle` maintains a vertex-indexed array `onStack[]` that marks the vertices on the recursive call stack (by setting `onStack[v]` to `true` on entry to `dfs(G, v)` and to `false` on exit). `DirectedCycle` also maintains an `edgeTo[]` array so that it can return the cycle when it is detected, in the same way as `DepthFirstPaths` (page 536) and `BreadthFirstPaths` (page 540) return paths.

Depth-first orders and topological sort. Precedence-constrained scheduling amounts to computing a topological order for the vertices of a DAG, as in this API:

```
public class Topological
    Topological(Digraph G)           topological-sorting constructor
    boolean isDAG()                 is G a DAG?
    Iterable<Integer> order()        vertices in topological order
```

API for topological sorting

Proposition E. A digraph has a topological order if and only if it is a DAG.

Proof: If the digraph has a directed cycle, it has no topological order. Conversely, the algorithm that we are about to examine computes a topological order for any given DAG.

Remarkably, it turns out that we have already seen an algorithm for topological sort: a one-line addition to our standard recursive DFS does the job! To convince you of this fact, we begin with the class `DepthFirstOrder` on page 580. It is based on the idea that depth-first search visits each vertex exactly once. If we save the vertex given as argument to the recursive `dfs()` in a data structure, then iterate through that data structure, we see all the graph vertices, in order determined by the nature of the data structure and by whether we do the save before or after the recursive calls. Three vertex orderings are of interest in typical applications:

- *Preorder*: Put the vertex on a queue before the recursive calls.
- *Postorder*: Put the vertex on a queue after the recursive calls.
- *Reverse postorder*: Put the vertex on a stack after the recursive calls.

A trace of `DepthFirstOrder` for our sample DAG is given on the facing page. It is simple to implement and supports `pre()`, `post()`, and `reversePost()` methods that are useful for advanced graph-processing algorithms. For example, `order()` in `Topological` consists of a call on `reversePost()`.

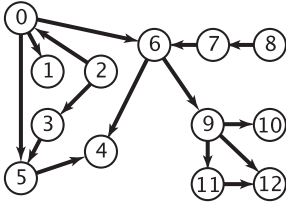

*preorder
is order of
dfs() calls*

*postorder
is order
in which
vertices
are done*

	<u>pre</u>		<u>post</u>		<u>reversePost</u>
dfs(0)	0				
dfs(5)	0 5				
dfs(4)	0 5 4	<i>queue</i>			
4 done			4	<i>queue</i>	4
5 done			4 5		5 4
dfs(1)	0 5 4 1				
1 done			4 5 1		1 5 4
dfs(6)	0 5 4 1 6				
dfs(9)	0 5 4 1 6 9				
dfs(11)	0 5 4 1 6 9 11				
dfs(12)	0 5 4 1 6 9 11 12				
12 done			4 5 1 12		12 1 5 4
11 done			4 5 1 12 11		11 12 1 5 4
dfs(10)	0 5 4 1 6 9 11 12 10				
10 done			4 5 1 12 11 10		10 11 12 1 5 4
check 12			4 5 1 12 11 10 9		9 10 11 12 1 5 4
9 done			4 5 1 12 11 10 9 6		6 9 10 11 12 1 5 4
check 4			4 5 1 12 11 10 9 6 0		0 6 9 10 11 12 1 5 4
6 done					
0 done					
check 1	0 5 4 1 6 9 11 12 10 2				
dfs(2)					
check 0	0 5 4 1 6 9 11 12 10 2 3				
dfs(3)					
check 5			4 5 1 12 11 10 9 6 0 3		3 0 6 9 10 11 12 1 5 4
3 done			4 5 1 12 11 10 9 6 0 3 2		2 3 0 6 9 10 11 12 1 5 4
2 done					
check 3					
check 4					
check 5					
check 6	0 5 4 1 6 9 11 12 10 2 3 7				
dfs(7)					
check 6			4 5 1 12 11 10 9 6 0 3 2 7		7 2 3 0 6 9 10 11 12 1 5 4
7 done					
dfs(8)	0 5 4 1 6 9 11 12 10 2 3 7 8				
check 7			4 5 1 12 11 10 9 6 0 3 2 7 8		8 7 2 3 0 6 9 10 11 12 1 5 4
8 done					
check 9					
check 10					
check 11					
check 12					

*reverse
postorder*

Computing depth-first orders in a digraph (preorder, postorder, and reverse postorder)

Depth-first search vertex ordering in a digraph

```

public class DepthFirstOrder
{
    private boolean[] marked;

    private Queue<Integer> pre;           // vertices in preorder
    private Queue<Integer> post;         // vertices in postorder
    private Stack<Integer> reversePost; // vertices in reverse postorder

    public DepthFirstOrder(Digraph G)
    {
        pre = new Queue<Integer>();
        post = new Queue<Integer>();
        reversePost = new Stack<Integer>();
        marked = new boolean[G.V()];

        for (int v = 0; v < G.V(); v++)
            if (!marked[v]) dfs(G, v);
    }

    private void dfs(Digraph G, int v)
    {
        pre.enqueue(v);
        marked[v] = true;
        for (int w : G.adj(v))
            if (!marked[w])
                dfs(G, w);

        post.enqueue(v);
        reversePost.push(v);
    }

    public Iterable<Integer> pre()
    { return pre; }
    public Iterable<Integer> post()
    { return post; }
    public Iterable<Integer> reversePost()
    { return reversePost; }
}

```

This class enables clients to iterate through the vertices in various orders defined by depth-first search. This ability is very useful in the development of advanced digraph-processing algorithms, because the recursive nature of the search enables us to prove properties of the computation (see, for example, PROPOSITION F).

ALGORITHM 4.5 Topological sort

```

public class Topological
{
    private Iterable<Integer> order;           // topological order
    public Topological(Digraph G)
    {
        DirectedCycle cyclefinder = new DirectedCycle(G);
        if (!cyclefinder.hasCycle())
        {
            DepthFirstOrder dfs = new DepthFirstOrder(G);
            order = dfs.reversePost();
        }
    }
    public Iterable<Integer> order()
    { return order; }
    public boolean isDAG()
    { return order == null; }
    public static void main(String[] args)
    {
        String filename = args[0];
        String separator = args[1];
        SymbolDigraph sg = new SymbolDigraph(filename, separator);

        Topological top = new Topological(sg.G());
        for (int v : top.order())
            StdOut.println(sg.name(v));
    }
}

```

This `DepthFirstOrder` and `DirectedCycle` client returns a topological order for a DAG. The test client solves the precedence-constrained scheduling problem for a `SymbolDigraph`. The instance method `order()` returns `null` if the given digraph is not a DAG and an iterator giving the vertices in topological order otherwise. The code for `SymbolDigraph` is omitted because it is precisely the same as for `SymbolGraph` (page 552), with `Digraph` replacing `Graph` everywhere.

Proposition F. Reverse postorder in a DAG is a topological sort.

Proof: Consider any edge $v \rightarrow w$. One of the following three cases must hold when $\text{dfs}(v)$ is called (see the diagram on page 583):

- $\text{dfs}(w)$ has already been called and has returned (w is marked).
- $\text{dfs}(w)$ has not yet been called (w is unmarked), so $v \rightarrow w$ will cause $\text{dfs}(w)$ to be called (and return), either directly or indirectly, before $\text{dfs}(v)$ returns.
- $\text{dfs}(w)$ has been called and has not yet returned when $\text{dfs}(v)$ is called. The key to the proof is that this case is impossible in a DAG, because the recursive call chain implies a path from w to v and $v \rightarrow w$ would complete a directed cycle.

In the two possible cases, $\text{dfs}(w)$ is done before $\text{dfs}(v)$, so w appears *before* v in postorder and *after* v in reverse postorder. Thus, each edge $v \rightarrow w$ points from a vertex earlier in the order to a vertex later in the order, as desired.

```
% more jobs.txt
Algorithms/Theoretical CS/Databases/Scientific Computing
Introduction to CS/Advanced Programming/Algorithms
Advanced Programming/Scientific Computing
Scientific Computing/Computational Biology
Theoretical CS/Computational Biology/Artificial Intelligence
Linear Algebra/Theoretical CS
Calculus/Linear Algebra
Artificial Intelligence/Neural Networks/Robotics/Machine Learning
Machine Learning/Neural Networks

% java Topological jobs.txt "/"
Calculus
Linear Algebra
Introduction to CS
Advanced Programming
Algorithms
Theoretical CS
Artificial Intelligence
Robotics
Machine Learning
Neural Networks
Databases
Scientific Computing
Computational Biology
```

Topological (ALGORITHM 4.5 on page 581) is an implementation that uses depth-first search to topologically sort a DAG. A trace is given at right.

Proposition G. With DFS, we can topologically sort a DAG in time proportional to $V+E$.

Proof: Immediate from the code. It uses one depth-first search to ensure that the graph has no directed cycles, and another to do the reverse postorder ordering. Both involve examining all the edges and all the vertices, and thus take time proportional to $V+E$.

Despite the simplicity of this algorithm, it escaped attention for many years, in favor of a more intuitive algorithm based on maintaining a queue of sources (see EXERCISE 4.2.30).

IN PRACTICE, topological sorting and cycle detection go hand in hand, with cycle detection playing the role of a debugging tool. For example, in a job-scheduling application, a directed cycle in the underlying digraph represents a mistake that must be corrected, no matter how the schedule was formulated. Thus, a job-scheduling application is typically a three-step process:

- Specify the tasks and precedence constraints.
- Make sure that a feasible solution exists, by detecting and removing cycles in the underlying digraph until none exist.
- Solve the scheduling problem, using topological sort.

Similarly, any changes in the schedule can be checked for cycles (using `DirectedCycle`), then a new schedule computed (using `Topological`).

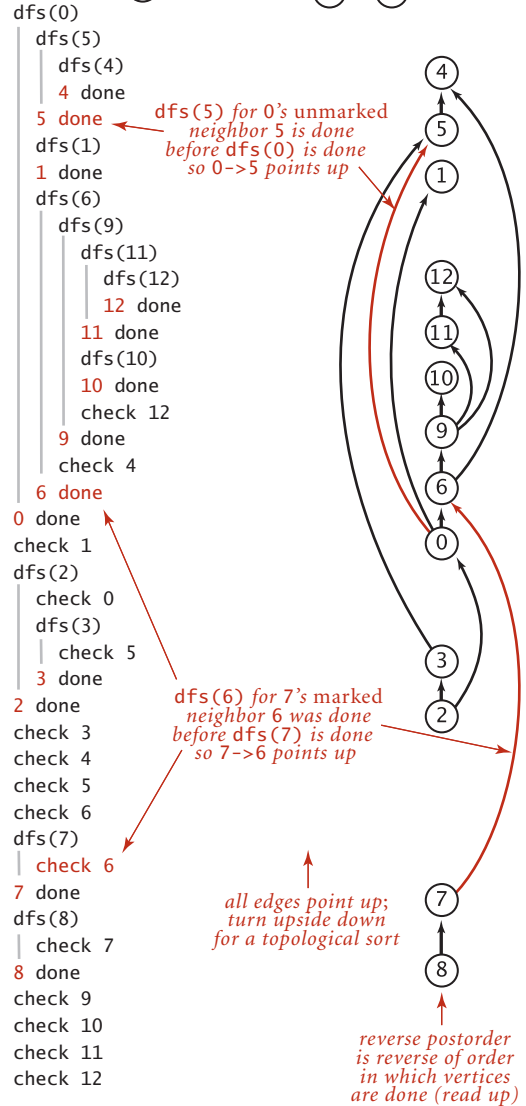
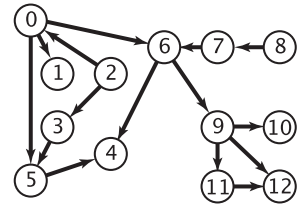

Reverse postorder in a DAG is a topological sort

Strong connectivity in digraphs We have been careful to maintain a distinction between reachability in digraphs and connectivity in undirected graphs. In an undirected graph, two vertices v and w are connected if there is a path connecting them—we can use that path to get from v to w or to get from w to v . In a digraph, by contrast, a vertex w is reachable from a vertex v if there is a directed path from v to w , but there may or may not be a directed path back to v from w . To complete our study of digraphs, we consider the natural analog of connectivity in undirected graphs.

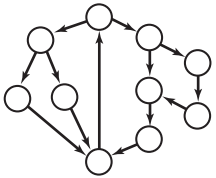
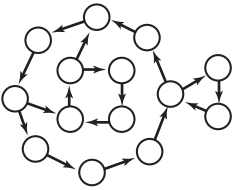

Strongly connected digraphs

Definition. Two vertices v and w are *strongly connected* if they are mutually reachable: that is, if there is a directed path from v to w and a directed path from w to v . A digraph is *strongly connected* if all its vertices are strongly connected to one another.

Several examples of strongly connected graphs are given in the figure at left. As you can see from the examples, cycles play an important role in understanding strong connectivity. Indeed, recalling that a general directed cycle is a directed cycle that may have repeated vertices, it is easy to see that *two vertices are strongly connected if and only if there exists a general directed cycle that contains them both*. (Proof: compose the paths from v to w and from w to v .)

Strong components. Like connectivity in undirected graphs, strong connectivity in digraphs is an equivalence relation on the set of vertices, as it has the following properties:

- *Reflexive:* Every vertex v is strongly connected to itself.
- *Symmetric:* If v is strongly connected to w , then w is strongly connected to v .
- *Transitive:* If v is strongly connected to w and w is strongly connected to x , then v is also strongly connected to x .

As an equivalence relation, strong connectivity partitions the vertices into equivalence classes. The equivalence classes are maximal subsets of vertices that are strongly connected to one another, with each vertex in exactly one subset. We refer to these subsets as *strongly connected components*, or *strong components* for short. Our sample digraph `tinyDG.txt` has five strong components, as shown in the diagram at right. A digraph with V vertices has between 1 and V strong components—a strongly

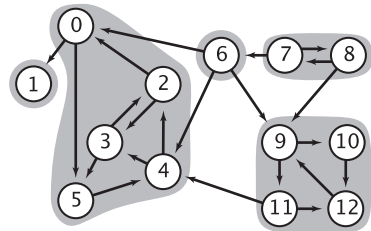

A digraph and its strong components

connected digraph has 1 strong component and a DAG has V strong components. Note that the strong components are defined in terms of the vertices, not the edges. Some edges connect two vertices in the same strong component; some other edges connect vertices in different strong components. The latter are not found on any directed cycle. Just as identifying connected components is typically important in processing undirected graphs, identifying strong components is typically important in processing digraphs.

Examples of applications. Strong connectivity is a useful abstraction in understanding the structure of a digraph, highlighting inter-related sets of vertices (strong components). For example, strong components can help textbook authors decide which topics should be grouped together and software developers decide how to organize program modules. The figure below shows an example from ecology. It illustrates a digraph that models the food web connecting living organisms, where vertices represent species and an edge from one vertex to another indicates that an organism of the species indicated by the *point from* vertex consumes organisms of the species indicated by the *point to* vertex for food. Scientific studies on such digraphs (with carefully chosen sets of species and carefully documented relationships) play an important role in helping ecologists answer basic questions about ecological systems. Strong components in such

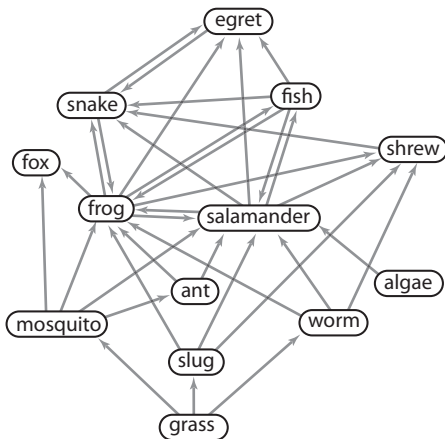

Small subset of food web digraph

application	vertex	edge
<i>web</i>	page	hyperlink
<i>textbook</i>	topic	reference
<i>software</i>	module	call
<i>food web</i>	organism	predator-prey relationship

Typical strong-component applications

digraphs can help ecologists understand energy flow in the food web. The figure on page 591 shows a digraph model of web content, where vertices represent pages and edges represent hyperlinks from one page to another. Strong components in such a digraph can help network engineers partition the huge number of pages on the web into more manageable sizes for processing. Further properties of these applications and other examples are addressed in the exercises and on the booksite.

Accordingly, we need the following API, the analog for digraphs of CC (page 543):

```
public class SCC
    SCC(Digraph G) preprocessing constructor
    boolean stronglyConnected(int v, int w) are v and w strongly connected?
    int count() number of strong components
    int id(int v) component identifier for v
                 (between 0 and count()-1)
```

API for strong components

A quadratic algorithm to compute strong components is not difficult to develop (see EXERCISE 4.2.23), but (as usual) quadratic time and space requirements are prohibitive for huge digraphs that arise in practical applications like the ones just described.

Kosaraju's algorithm. We saw in CC (ALGORITHM 4.3 on page 544) that computing connected components in undirected graphs is a simple application of depth-first search. How can we efficiently compute strong components in digraphs? Remarkably, the implementation `KosarajuSCC` on the facing page does the job with just a few lines of code added to CC, as follows:

- Given a digraph G , use `DepthFirstOrder` to compute the reverse postorder of its reverse, G^R .
- Run standard DFS on G , but consider the unmarked vertices in the order just computed instead of the standard numerical order.
- All vertices reached on a call to the recursive `dfs()` from the constructor are *in a strong component* (!), so identify them as in CC.

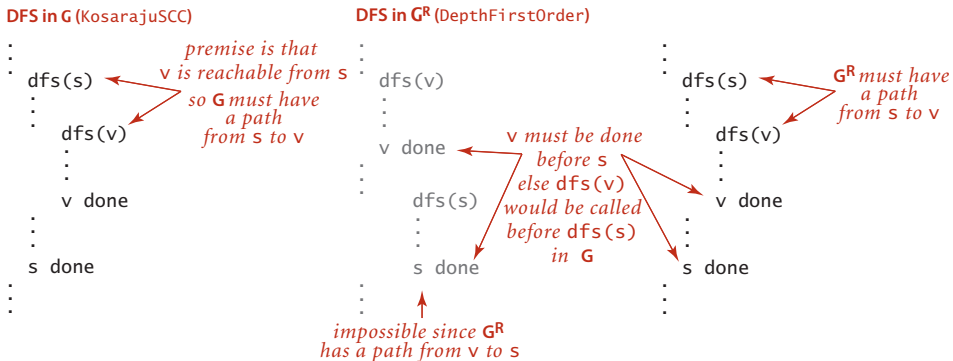

Proof of correctness for Kosaraju's algorithm

ALGORITHM 4.6 Kosaraju's algorithm for computing strong components

```

public class KosarajuSCC
{
    private boolean[] marked;    // reached vertices
    private int[] id;           // component identifiers
    private int count;          // number of strong components

    public KosarajuSCC(Digraph G)
    {
        marked = new boolean[G.V()];
        id = new int[G.V()];
        DepthFirstOrder order = new DepthFirstOrder(G.reverse());
        for (int s : order.reversePost())
            if (!marked[s])
                { dfs(G, s); count++; }
    }

    private void dfs(Digraph G, int v)
    {
        marked[v] = true;
        id[v] = count;
        for (int w : G.adj(v))
            if (!marked[w])
                dfs(G, w);
    }

    public boolean stronglyConnected(int v, int w)
    { return id[v] == id[w]; }

    public int id(int v)
    { return id[v]; }

    public int count()
    { return count; }
}

```

```

% java KosarajuSCC tinyDG.txt
5 components
1
0 5 4 3 2
11 12 9 10
6
8 7

```

This implementation differs from CC (ALGORITHM 4.3) only in the highlighted code (and in the implementation of `main()` where we use the code on page 543, with `Graph` changed to `Digraph`, and `CC` changed to `KosarajuSCC`). To find strong components, it does a depth-first search in the reverse digraph to produce a vertex order (reverse postorder of that search) for use in a depth-first search of the given digraph.

Kosaraju's algorithm is an extreme example of a method that is easy to code but difficult to understand. Despite its mysterious nature, if you follow the proof of the following proposition step by step, with reference to the diagram on page 586, you can be convinced that the algorithm is correct:

Proposition H. In a DFS of a digraph G where marked vertices are considered in reverse postorder given by a DFS of the digraph's reverse G^R (Kosaraju's algorithm), the vertices reached in each call of the recursive method from the constructor are in a strong component.

Proof: First, we prove by contradiction that *every vertex v that is strongly connected to s is reached by the call $\text{dfs}(G, s)$ in the constructor*. Suppose a vertex v that is strongly connected to s is not reached by $\text{dfs}(G, s)$. Since there is a path from s to v , v must have been previously marked. But then, since there is a path from v to s , s would have been marked during the call $\text{dfs}(G, v)$ and the constructor would not call $\text{dfs}(G, s)$, a contradiction.

Second, we prove that *every vertex v reached by the call $\text{dfs}(G, s)$ in the constructor is strongly connected to s* . Let v be a vertex reached by the call $\text{dfs}(G, s)$. Then, there is a path from s to v in G , so it remains only to prove that there is a path from v to s in G . This statement is equivalent to saying that there is a path from s to v in G^R , so it remains only to prove that there is a path from s to v in G^R .

The crux of the proof is that the reverse postorder construction implies that $\text{dfs}(G, v)$ must have been done before $\text{dfs}(G, s)$ during the DFS of G^R , leaving just two cases to consider for $\text{dfs}(G, v)$: it might have been called

- before $\text{dfs}(G, s)$ was called (and also done before $\text{dfs}(G, s)$ was called)
- after $\text{dfs}(G, s)$ was called (and done before $\text{dfs}(G, s)$ was done)

The first of these is not possible because there is a path from v to s in G^R ; the second implies that there is a path from s to v in G^R , completing the proof.

A trace of Kosaraju's algorithm for `tinyDG.txt` is shown on the facing page. To the right of each DFS trace appears a drawing of the digraph, with vertices appearing in the order they are done. Thus reading up the reverse digraph drawing on the left gives reverse postorder, the order in which unmarked vertices are checked in the DFS of the original digraph. As you can see from the diagram, the second DFS calls $\text{dfs}(1)$ (which marks vertex 1) then calls $\text{dfs}(0)$ (which marks 5, 4, 3, and 2), then checks 2, 4, 5, and 3, then calls $\text{dfs}(11)$ (which marks 11, 12, 9, and 10), then checks 9, 12, and 10, then calls $\text{dfs}(6)$ (which marks 6), and finally $\text{dfs}(7)$, which marks 7 and 8.

DFS in reverse digraph (ReversePost)

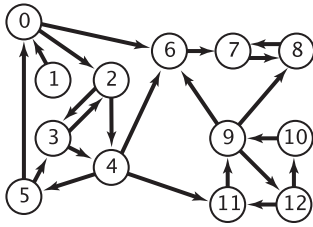

check unmarked vertices in the order

0 1 2 3 4 5 6 7 8 9 10 11 12

```

dfs(0)
  dfs(6)
    dfs(7)
      dfs(8)
        check 7
        8 done
      7 done
    6 done
  dfs(2)
    dfs(4)
      dfs(11)
        dfs(9)
          dfs(12)
            check 11
            dfs(10)
              check 9
              10 done
            12 done
            check 8
            check 6
          9 done
        11 done
        check 6
      dfs(5)
        dfs(3)
          check 4
          check 2
        3 done
        check 0
      5 done
    4 done
    check 3
  2 done
0 done
dfs(1)
  check 0
  1 done
check 2
check 3
check 4
check 5
check 6
check 7
check 8
check 9
check 10
check 11
check 12
    
```

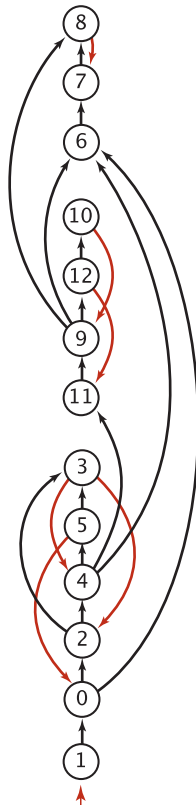

reverse postorder for use in second dfs() (read up)

DFS in original digraph

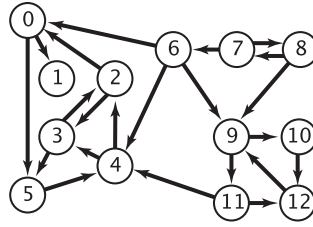

check unmarked vertices in the order

1 0 2 4 5 3 11 9 12 10 6 7 8

```

dfs(1)
  1 done
dfs(0)
  dfs(5)
    dfs(4)
      dfs(3)
        check 5
        dfs(2)
          check 0
          check 3
        2 done
      3 done
      check 2
    4 done
    5 done
    check 1
  0 done
  check 2
  check 4
  check 5
  check 3
dfs(11)
  check 4
  dfs(12)
    dfs(9)
      check 11
      dfs(10)
        check 12
        10 done
      9 done
    12 done
  11 done
  check 9
  check 12
  check 10
dfs(6)
  check 9
  check 4
  check 0
  6 done
dfs(7)
  check 6
  dfs(8)
    check 7
    check 9
  8 done
  7 done
  check 8
    
```

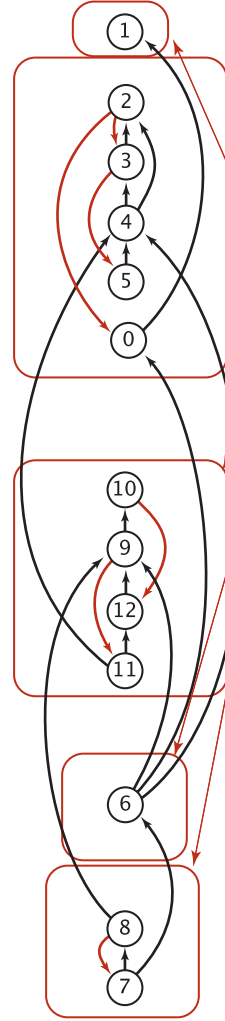

strong components

Kosaraju's algorithm for finding strong components in digraphs

A larger example, a very small subset of a digraph model of the web, is shown on the facing page.

KOSARAJU'S ALGORITHM SOLVES the following analog of the connectivity problem for undirected graphs that we first posed in CHAPTER 1 and reintroduced in SECTION 4.1 (page 534):

Strong connectivity. Given a digraph, support queries of the form: *Are two given vertices strongly connected?* and *How many strong components does the digraph have?*

That we can solve this problem in digraphs as efficiently as the corresponding connectivity problem in undirected graphs was an open research problem for some time (resolved by R. E. Tarjan in the late 1970s). That such a simple solution is now available is quite surprising.

Proposition 1. Kosaraju's algorithm uses preprocessing time and space proportional to $V+E$ to support constant-time strong connectivity queries in a digraph.

Proof: The algorithm computes the reverse of the digraph and does two depth-first searches. Each of these three steps takes time proportional to $V+E$. The reverse copy of the digraph uses space proportional to $V+E$.

Reachability revisited. With CC for undirected graphs, we can infer from the fact that two vertices v and w are connected that there is a path from v to w and a path (the same one) from w to v . With KosarajuCC, we can infer from the fact that v and w are strongly connected that there is a path from v to w and a path (a different one) from w to v . But what about pairs of vertices that are not strongly connected? There may be a path from v to w or a path from w to v or neither, but not both.

All-pairs reachability. Given a digraph, support queries of the form *Is there a directed path from a given vertex v to another given vertex w ?*

For undirected graphs, the corresponding problem is equivalent to the connectivity problem; for digraphs, it is quite different from the strong connectivity problem. Our CC implementation uses linear preprocessing time to support constant-time answers to such queries for undirected graphs. Can we achieve this performance for digraphs? This seemingly innocuous question has confounded experts for decades. To better

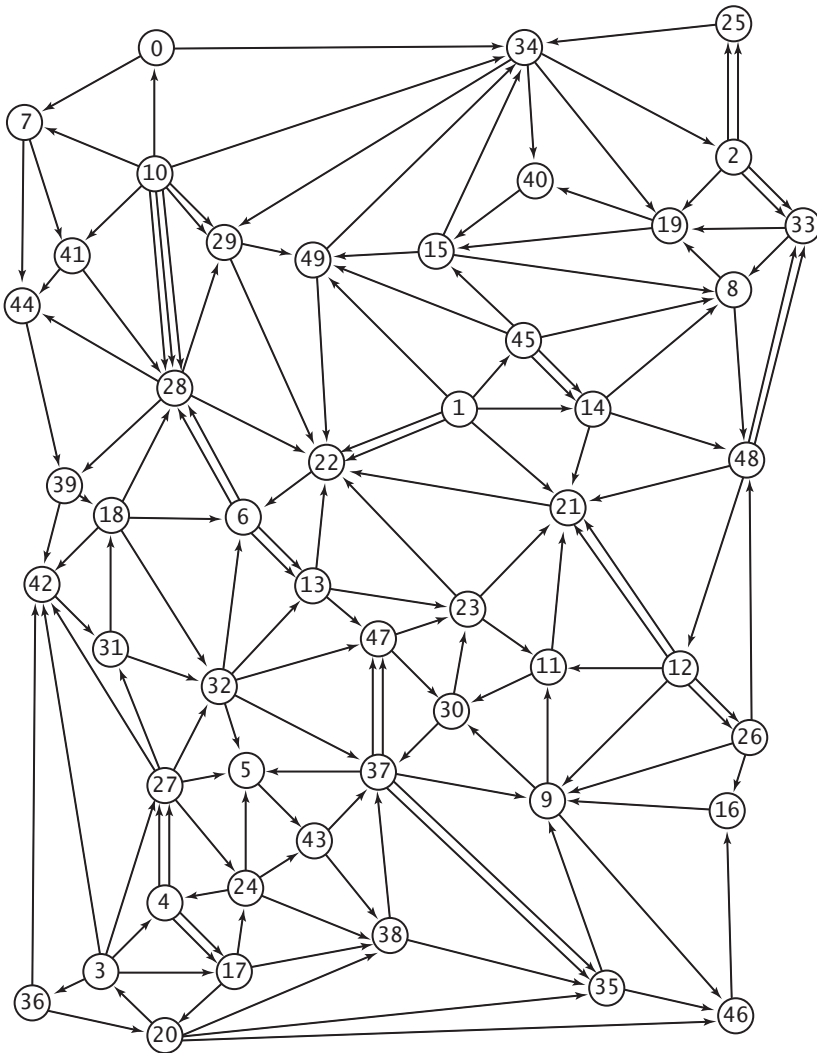

How many strong components are there in this digraph?

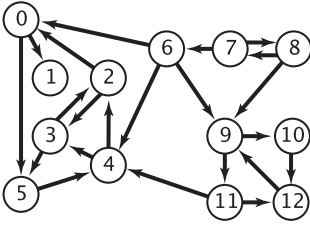

	0	1	2	3	4	5	6	7	8	9	10	11	12
0	T	T	T	T	T	T	T						
1		T											
2	T	T	T	T	T	T							
3	T	T	T	T	T	T							
4	T	T	T	T	T	T							
5	T	T	T	T	T	T							
6	T	T	T	T	T	T	T			T	T	T	T
7	T	T	T	T	T	T	T	T	T	T	T	T	T
8	T	T	T	T	T	T	T	T	T	T	T	T	T
9	T	T	T	T	T	T			T	T	T	T	T
10	T	T	T	T	T	T			T	T	T	T	T
11	T	T	T	T	T	T			T	T	T	T	T
12	T	T	T	T	T	T			T	T	T	T	T

Transitive closure

we normally represent them with a matrix of boolean values, where the entry in row v and column w is true if and only if w is reachable from v . Instead of explicitly computing the transitive closure, we use depth-first search to implement the following API:

```
public class TransitiveClosure
```

```
    TransitiveClosure(Digraph G)           preprocessing constructor
    boolean reachable(int v, int w)       is w reachable from v?
```

API for all-pairs reachability

The code at the top of the next page is a straightforward implementation that uses `DirectedDFS` (ALGORITHM 4.4). This solution is ideal for small or dense digraphs, but it is not a solution for the large digraphs we might encounter in practice because *the constructor uses space proportional to V^2 and time proportional to $V(V+E)$* : each of the `DirectedDFS` objects takes space proportional to V (they all have `marked[]` arrays of size V and examine E edges to compute the marks). Essentially, `TransitiveClosure`

understand the challenge, consider the diagram at left, which illustrates the following fundamental concept:

Definition. The *transitive closure* of a digraph G is another digraph with the same set of vertices, but with an edge from v to w in the transitive closure if and only if w is reachable from v in G .

By convention, every vertex is reachable from itself, so the transitive closure has V self-loops. Our sample digraph has just 13 directed edges, but its transitive closure has 102 out of a possible 169 directed edges. Generally, the transitive closure of a digraph has many more edges than the digraph itself, and it is not at all unusual for a sparse graph to have a dense transitive closure. For example, the transitive closure of a V -vertex directed cycle, which has V directed edges, is a complete digraph with V^2 directed edges. Since transitive closures are typically dense,

computes and stores the transitive closure of G , to support constant-time queries—row v in the transitive closure matrix is the `marked[]` array for the v th entry in the `DirectedDFS[]` in `TransitiveClosure`. Can we support constant-time queries with substantially less preprocessing time and substantially less space? A general solution that achieves constant-time queries with substantially less than quadratic space is an unsolved research problem, with important practical implications: for example, until it is solved, we cannot hope to have a practical solution to the all-pairs reachability problem for a giant digraph such as the web graph.

```
public class TransitiveClosure
{
    private DirectedDFS[] all;
    TransitiveClosure(Digraph G)
    {
        all = new DirectedDFS[G.V()];
        for (int v = 0; v < G.V(); v++)
            all[v] = new DirectedDFS(G, v);
    }

    boolean reachable(int v, int w)
    { return all[v].marked(w); }
}
```

All-pairs reachability

Summary In this section, we have introduced directed edges and digraphs, emphasizing the relationship between digraph processing and corresponding problems for undirected graphs, as summarized in the following list of topics:

- Digraph nomenclature
- The idea that the representation and approach are essentially the same as for undirected graphs, but some digraph problems are more complicated
- Cycles, DAGs, topological sort, and precedence-constrained scheduling
- Reachability, paths, and strong connectivity in digraphs

The table below summarizes the implementations of digraph algorithms that we have considered (all but one of the algorithms are based on depth-first search). The problems addressed are all simply stated, but the solutions that we have considered range from easy adaptations of corresponding algorithms for undirected graphs to an ingenious and surprising solution. These algorithms are a starting point for several of the more complicated algorithms that we consider in SECTION 4.4, when we consider *edge-weighted* digraphs.

problem	solution	reference
<i>single- and multiple-source reachability</i>	DirectedDFS	page 571
<i>single-source directed paths</i>	DepthFirstDirectedPaths	page 573
<i>single-source shortest directed paths</i>	BreadthFirstDirectedPaths	page 573
<i>directed cycle detection</i>	DirectedCycle	page 577
<i>depth-first vertex orders</i>	DepthFirstOrder	page 580
<i>precedence-constrained scheduling</i>	Topological	page 581
<i>topological sort</i>	Topological	page 581
<i>strong connectivity</i>	KosarajuSCC	page 587
<i>all-pairs reachability</i>	TransitiveClosure	page 593

Digraph-processing problems addressed in this section

Q&A

Q. Is a self-loop a cycle?

A. Yes, but no self-loop is needed for a vertex to be reachable from itself.

EXERCISES

4.2.1 What is the maximum number of edges in a digraph with V vertices and no parallel edges? What is the minimum number of edges in a digraph with V vertices, none of which are isolated?

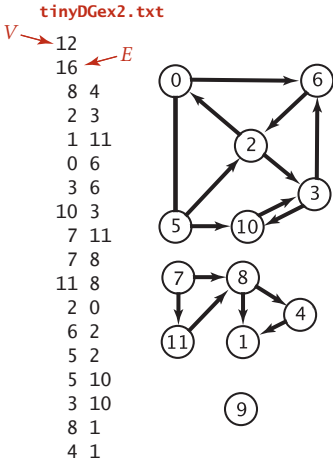

4.2.2 Draw, in the style of the figure in the text (page 524), the adjacency lists built by `Digraph`'s input stream constructor for the file `tinyDGex2.txt` depicted at left.

4.2.3 Create a copy constructor for `Digraph` that takes as input a digraph G and creates and initializes a new copy of the digraph. Any changes a client makes to G should not affect the newly created digraph.

4.2.4 Add a method `hasEdge()` to `Digraph` which takes two `int` arguments v and w and returns `true` if the graph has an edge $v \rightarrow w$, `false` otherwise.

4.2.5 Modify `Digraph` to disallow parallel edges and self-loops.

4.2.6 Develop a test client for `Digraph`.

4.2.7 The *indegree* of a vertex in a digraph is the number of directed edges that point to that vertex. The *outdegree* of a vertex in a digraph is the number of directed edges that emanate from that vertex. No vertex is reachable from a vertex of outdegree 0, which is called a *sink*; a vertex of indegree 0, which is called a *source*, is not reachable from any other vertex. A digraph where self-loops are allowed *and* every vertex has outdegree 1 is called a *map* (a function from the set of integers from 0 to $V-1$ onto itself). Write a program `Degrees.java` that implements the following API:

```

public class Degrees
{
    Degrees(Digraph G)           constructor
    int  indegree(int v)         indegree of v
    int  outdegree(int v)        outdegree of v
    Iterable<Integer> sources()  sources
    Iterable<Integer> sinks()    sinks
    boolean isMap()              is G a map?
}

```

4.2.8 Draw all the nonisomorphic DAGs with two, three, four, and five vertices (see EXERCISE 4.1.28).

4.2.9 Write a method that checks whether or not a given permutation of a DAG's vertices is a topological order of that DAG.

4.2.10 Given a DAG, does there exist a topological order that cannot result from applying a DFS-based algorithm, no matter in what order the vertices adjacent to each vertex are chosen? Prove your answer.

4.2.11 Describe a family of sparse digraphs whose number of directed cycles grows exponentially in the number of vertices.

4.2.12 How many edges are there in the transitive closure of a digraph that is a simple directed path with V vertices and $V-1$ edges?

4.2.13 Give the transitive closure of the digraph with ten vertices and these edges:

3→7 1→4 7→8 0→5 5→2 3→8 2→9 0→6 4→9 2→6 6→4

4.2.14 Prove that the strong components in G^R are the same as in G .

4.2.15 What are the strong components of a DAG?

4.2.16 What happens if you run Kosaraju's algorithm on a DAG?

4.2.17 True or false: The reverse postorder of a graph's reverse is the same as the postorder of the graph.

4.2.18 Compute the memory usage of a Digraph with V vertices and E edges, under the memory cost model of SECTION 1.4.

CREATIVE PROBLEMS

4.2.19 *Topological sort and BFS.* Explain why the following algorithm does not necessarily produce a topological order: Run BFS, and label the vertices by increasing distance to their respective source.

4.2.20 *Directed Eulerian cycle.* An Eulerian cycle is a directed cycle that contains each edge exactly once. Write a graph client `Euler` that finds an Eulerian cycle or reports that no such tour exists. *Hint:* Prove that a digraph G has a directed Eulerian cycle if and only if G is connected and each vertex has its indegree equal to its outdegree.

4.2.21 *LCA of a DAG.* Given a DAG and two vertices v and w , find the *lowest common ancestor* (LCA) of v and w . The LCA of v and w is an ancestor of v and w that has no descendants that are also ancestors of v and w . Computing the LCA is useful in multiple inheritance in programming languages, analysis of genealogical data (find degree of inbreeding in a pedigree graph), and other applications. *Hint:* Define the height of a vertex v in a DAG to be the length of the longest path from a root to v . Among vertices that are ancestors of both v and w , the one with the greatest height is an LCA of v and w .

4.2.22 *Shortest ancestral path.* Given a DAG and two vertices v and w , find the *shortest ancestral path* between v and w . An ancestral path between v and w is a common ancestor x along with a shortest path from v to x and a shortest path from w to x . The shortest ancestral path is the ancestral path whose total length is minimized. *Warmup:* Find a DAG where the shortest ancestral path goes to a common ancestor x that is not an LCA. *Hint:* Run BFS twice, once from v and once from w .

4.2.23 *Strong component.* Describe a linear-time algorithm for computing the strong connected component containing a given vertex v . On the basis of that algorithm, describe a simple quadratic algorithm for computing the strong components of a digraph.

4.2.24 *Hamiltonian path in DAGs.* Given a DAG, design a linear-time algorithm to determine whether there is a directed path that visits each vertex exactly once.

Answer: Compute a topological sort and check if there is an edge between each consecutive pair of vertices in the topological order.

4.2.25 *Unique topological ordering.* Design an algorithm to determine whether a digraph has a unique topological ordering. *Hint:* A digraph has a unique topological ordering if and only if there is a directed edge between each pair of consecutive vertices in the topological order (i.e., the digraph has a Hamiltonian path). If the digraph has

multiple topological orderings, then a second topological order can be obtained by swapping a pair of consecutive vertices.

4.2.26 *2-satisfiability.* Given boolean formula in conjunctive normal form with M clauses and N literals such that each clause has exactly two literals, find a satisfying assignment (if one exists). *Hint:* Form the *implication digraph* with $2N$ vertices (one per literal and its negation). For each clause $x + y$, include edges from y' to x and from x' to y . To satisfy the clause $x + y$, (i) if y is false, then x is true and (ii) if x is false, then y is true. *Claim:* The formula is satisfiable if and only if no variable x is in the same strong component as its negation x' . Moreover, a topological sort of the *kernel DAG* (contract each strong component to a single vertex) yields a satisfying assignment.

4.2.27 *Digraph enumeration.* Show that the number of different V -vertex digraphs with no parallel edges is 2^{V^2} . (How many digraphs are there that contain V vertices and E edges?) Then compute an upper bound on the percentage of 20-vertex digraphs that could ever be examined by any computer, under the assumptions that every electron in the universe examines a digraph every nanosecond, that the universe has fewer than 10^{80} electrons, and that the age of the universe will be less than 10^{20} years.

4.2.28 *DAG enumeration.* Give a formula for the number of V -vertex DAGs with E edges.

4.2.29 *Arithmetic expressions.* Write a class that evaluates DAGs that represent arithmetic expressions. Use a vertex-indexed array to hold values corresponding to each vertex. Assume that values corresponding to leaves have been established. Describe a family of arithmetic expressions with the property that the size of the expression tree is exponentially larger than the size of the corresponding DAG (so the running time of your program for the DAG is proportional to the logarithm of the running time for the tree).

4.2.30 *Queue-based topological sort.* Develop a topological sort implementation that maintains a vertex-indexed array that keeps track of the indegree of each vertex. Initialize the array and a queue of sources in a single pass through all the edges, as in EXERCISE 4.2.7. Then, perform the following operations until the source queue is empty:

- Remove a source from the queue and label it.
- Decrement the entries in the indegree array corresponding to the destination vertex of each of the removed vertex's edges.

CREATIVE PROBLEMS *(continued)*

- If decrementing any entry causes it to become 0, insert the corresponding vertex onto the source queue.

4.2.31 *Euclidean digraphs.* Modify your solution to EXERCISE 4.1.37 to create an API `EuclideanDigraph` for graphs whose vertices are points in the plane, so that you can work with graphical representations.

EXPERIMENTS

4.2.32 *Random digraphs.* Write a program `ErdosRenyiDigraph` that takes integer values V and E from the command line and builds a digraph by generating E random pairs of integers between 0 and $V-1$. *Note:* This generator produces self-loops and parallel edges.

4.2.33 *Random simple digraphs.* Write a program `RandomDigraph` that takes integer values V and E from the command line and produces, with equal likelihood, each of the possible *simple* digraphs with V vertices and E edges.

4.2.34 *Random sparse digraphs.* Modify your solution to EXERCISE 4.1.41 to create a program `RandomSparseDigraph` that generates random sparse digraphs for a well-chosen set of values of V and E that you can use it to run meaningful empirical tests.

4.2.35 *Random Euclidean digraphs.* Modify your solution to EXERCISE 4.1.42 to create a `EuclideanDigraph` client `RandomEuclideanDigraph` that assigns a random direction to each edge.

4.2.36 *Random grid digraphs.* Modify your solution to EXERCISE 4.1.43 to create a `EuclideanDigraph` client `RandomGridDigraph` that assigns a random direction to each edge.

4.2.37 *Real-world digraphs.* Find a large digraph somewhere online—perhaps a transaction graph in some online system, or a digraph defined by links on web pages. Write a program `RandomRealDigraph` that builds a graph by choosing V vertices at random and E directed edges at random from the subgraph induced by those vertices.

4.2.38 *Real-world DAG.* Find a large DAG somewhere online—perhaps one defined by class-definition dependencies in a large software system, or by directory links in a large file system. Write a program `RandomRealDAG` that builds a graph by choosing V vertices at random and E directed edges at random from the subgraph induced by those vertices.

EXPERIMENTS *(continued)*

Testing all algorithms and studying all parameters against all graph models is unrealistic. For each problem listed below, write a client that addresses the problem for any given input graph, then choose among the generators above to run experiments for that graph model. Use your judgment in selecting experiments, perhaps in response to results of previous experiments. Write a narrative explaining your results and any conclusions that might be drawn.

4.2.39 *Reachability.* Run experiments to determine empirically the average number of vertices that are reachable from a randomly chosen vertex, for various digraph models.

4.2.40 *Path lengths in DFS.* Run experiments to determine empirically the probability that `DepthFirstDirectedPaths` finds a path between two randomly chosen vertices and to calculate the average length of the paths found, for various random digraph models.

4.2.41 *Path lengths in BFS.* Run experiments to determine empirically the probability that `BreadthFirstDirectedPaths` finds a path between two randomly chosen vertices and to calculate the average length of the paths found, for various random digraph models.

4.2.42 *Strong components.* Run experiments to determine empirically the distribution of the number of strong components in random digraphs of various types, by generating large numbers of digraphs and drawing a histogram.

This page intentionally left blank

4.3 MINIMUM SPANNING TREES

AN *edge-weighted graph* is a graph model where we associate *weights* or *costs* with each edge. Such graphs are natural models for many applications. In an airline map where edges represent flight routes, these weights might represent distances or fares. In an electric circuit where edges represent wires, the weights might represent the length of the wire, its cost, or the time that it takes a signal to propagate through it. Minimizing cost is naturally of interest in such situations. In this section, we consider *undirected* edge-weighted graph models and examine algorithms for one such problem:

Minimum spanning tree. Given an undirected edge-weighted graph, find an MST.

Definition. Recall that a *spanning tree* of a graph is a connected subgraph with no cycles that includes all the vertices. A *minimum spanning tree* (MST) of an edge-weighted graph is a spanning tree whose weight (the sum of the weights of its edges) is no larger than the weight of any other spanning tree.

In this section, we examine two classical algorithms for computing MSTs: *Prim's algorithm* and *Kruskal's algorithm*. These algorithms are easy to understand and not difficult to implement. They are among the oldest and most well-known algorithms in this book, and they also take good advantage of modern data structures. Since MSTs have numerous important applications, algorithms to solve the problem have been studied at least since the 1920s, at first in the context of power distribution networks, later in the context of telephone networks. MST algorithms are now important in the design of many types of networks (communication, electrical, hydraulic, computer, road, rail, air, and many others) and also in the study of biological, chemical, and physical networks that are found in nature.

tinyEWG.txt

```

V → 8
      ← E
16
4 5 0.35
4 7 0.37
5 7 0.28
0 7 0.16
1 5 0.32
0 4 0.38
2 3 0.17
1 7 0.19
0 2 0.26
1 2 0.36
1 3 0.29
2 7 0.34
6 2 0.40
3 6 0.52
6 0 0.58
6 4 0.93
    
```

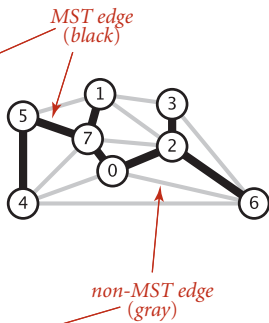

An edge-weighted graph and its MST

application	vertex	edge
<i>circuit</i>	component	wire
<i>airline</i>	airport	flight route
<i>power distribution</i>	power plant	transmission lines
<i>image analysis</i>	feature	proximity relationship

Typical MST applications

Assumptions. Various anomalous situations, which are generally easy to handle, can arise when computing minimum spanning trees. To streamline the presentation, we adopt the following conventions:

- *The graph is connected.* The spanning-tree condition in our definition implies that the graph must be connected for an MST to exist. Another way to pose the problem, recalling basic properties of trees from SECTION 4.1, is to find a minimal-weight set of $V-1$ edges that connect the graph. If a graph is not connected, we can adapt our algorithms to compute the MSTs of each of its connected components, collectively known as a *minimum spanning forest* (see EXERCISE 4.3.22).
- *The edge weights are not necessarily distances.* Geometric intuition is sometimes beneficial in understanding algorithms, so we use examples where vertices are points in the plane and weights are distances, such as the graph on the facing page. But it is important to remember that the weights might represent time or cost or an entirely different variable and do not need to be proportional to a distance at all.
- *The edge weights may be zero or negative.* If the edge weights are all positive, it suffices to define the MST as the subgraph with minimal total weight that connects all the vertices, as such a subgraph must form a spanning tree. The spanning-tree condition in the definition is included so that it applies for graphs that may have zero negative edge weights.
- *The edge weights are all different.* If edges can have equal weights, the minimum spanning tree may not be unique (see EXERCISE 4.3.2). The possibility of multiple MSTs complicates the correctness proofs of some of our algorithms, so we rule out that possibility in the presentation. It turns out that this assumption is not restrictive because our algorithms work without modification in the presence of equal weights.

In summary, we assume throughout the presentation that our job is to find the MST of a connected edge-weighted graph with arbitrary (but distinct) weights.

no MST if graph is not connected

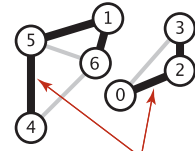

can independently compute MSTs of components

4 5	0.61
4 6	0.62
5 6	0.88
1 5	0.11
2 3	0.35
0 3	0.6
1 6	0.10
0 2	0.22

weights need not be proportional to distance

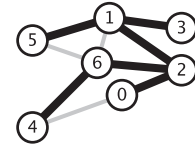

4 6	0.62
5 6	0.88
1 5	0.02
0 4	0.64
1 6	0.90
0 2	0.22
1 2	0.50
1 3	0.97
2 6	0.17

weights can be 0 or negative

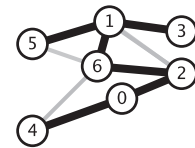

4 6	0.62
5 6	0.88
1 5	0.02
0 4	-0.99
1 6	0
0 2	0.22
1 2	0.50
1 3	0.97
2 6	0.17

MST may not be unique when weights have equal values



1 2	1.00
1 3	0.50
2 4	1.00
3 4	0.50



1 2	1.00
1 3	0.50
2 4	1.00
3 4	0.50

Various MST anomalies

Underlying principles To begin, we recall from SECTION 4.1 two of the defining properties of a tree:

- Adding an edge that connects two vertices in a tree creates a unique cycle.
- Removing an edge from a tree breaks it into two separate subtrees.

These properties are the basis for proving a fundamental property of MSTs that leads to the MST algorithms that we consider in this section.

Cut property. This property, which we refer to as the *cut property*, has to do with identifying edges that must be in the MST of a given edge-weighted graph, by dividing vertices into two sets and examining edges that cross the division.

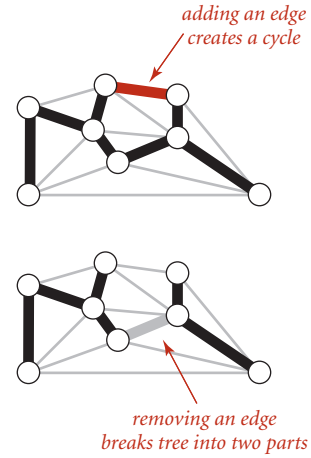

Basic properties of a tree

Definition. A *cut* of a graph is a partition of its vertices into two nonempty disjoint sets. A *crossing edge* of a cut is an edge that connects a vertex in one set with a vertex in the other.

Typically, we specify a cut by specifying a set of vertices, leaving implicit the assumption that the cut comprises the given vertex set and its complement, so that a crossing edge is an edge from a vertex in the set to a vertex not in the set. In figures, we draw vertices on one side of the cut in gray and vertices on the other side in white.

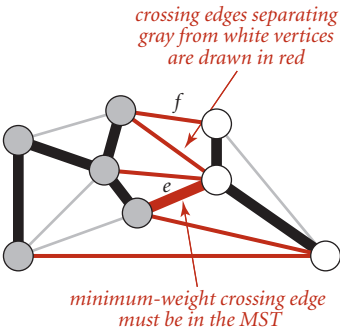

Cut property

Proposition J. (Cut property) Given any cut in an edge-weighted graph, the crossing edge of minimum weight is in the MST of the graph.

Proof: Let e be the crossing edge of minimum weight and let T be the MST. The proof is by contradiction: Suppose that T does not contain e . Now consider the graph formed by adding e to T . This graph has a cycle that contains e , and that cycle must contain at least one other crossing edge—say, f , which has higher weight than e (since e is minimal and all edge weights are different). We can get a spanning tree of strictly lower weight by deleting f and adding e , contradicting the assumed minimality of T .

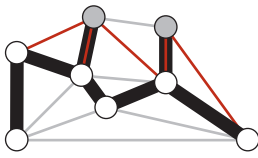

A cut with two MST edges

Under our assumption that edge weights are distinct, every connected graph has a unique MST (see EXERCISE 4.3.3); and the cut property says that the shortest crossing edge for every cut must be in the MST. The figure to the left of PROPOSITION J illustrates the cut property. Note that there is no requirement that the minimal edge be the *only* MST edge connecting the two sets; indeed, for typical cuts there are several MST edges that connect a vertex in one set with a vertex in the other, as illustrated in the figure above.

Greedy algorithm. The cut property is the basis for the algorithms that we consider for the MST problem. Specifically, they are special cases of a general paradigm known as the *greedy algorithm*: apply the cut property to accept an edge as an MST edge, continuing until finding all of the MST edges. Our algorithms differ in their approaches to maintaining cuts and identifying the crossing edge of minimum weight, but are special cases of the following:

Proposition K. (Greedy MST algorithm) The following method colors black all edges in the the MST of any connected edge-weighted graph with V vertices: starting with all edges colored gray, find a cut with no black edges, color its minimum-weight edge black, and continue until $V-1$ edges have been colored black.

Proof: For simplicity, we assume in the discussion that the edge weights are all different, though the proposition is still true when that is not the case (see EXERCISE 4.3.5). By the cut property, any edge that is colored black is in the MST. If fewer than $V-1$ edges are black, a cut with no black edges exists (recall that we assume the graph to be connected). Once $V-1$ edges are black, the black edges form a spanning tree.

The diagram at right is a typical trace of the greedy algorithm. Each drawing depicts a cut and identifies the minimum-weight edge in the cut (thick red) that is added to the MST by the algorithm.

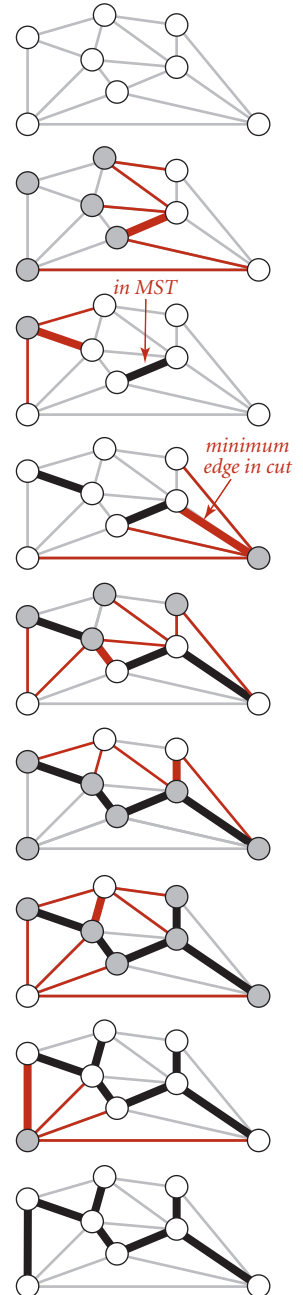

Greedy MST algorithm

Edge-weighted graph data type How should we represent edge-weighted graphs? Perhaps the simplest way to proceed is to extend the basic graph representations from SECTION 4.1: in the adjacency-matrix representation, the matrix can contain edge weights rather than boolean values; in the adjacency-lists representation, we can define a node that contains both a vertex and a weight field to put in the adjacency lists. (As usual, we focus on sparse graphs and leave the adjacency-matrix representation for exercises.) This classic approach is appealing, but we will use a different method that is not much more complicated, will make our programs useful in more general settings, and needs a slightly more general API, which allows us to process Edge objects:

```
public class Edge implements Comparable<Edge>
    Edge(int v, int w, double weight) initializing constructor
    double weight() weight of this edge
    int either() either of this edge's vertices
    int other(int v) the other vertex
    int compareTo(Edge that) compare this edge to e
    String toString() string representation
```

API for a weighted edge

The `either()` and `other()` methods for accessing the edge's vertices may be a bit puzzling at first—the need for them will become plain when we examine client code. You can find an implementation of `Edge` on page 610. It is the basis for this `EdgeWeightedGraph` API, which refers to `Edge` objects in a natural manner:

```
public class EdgeWeightedGraph
    EdgeWeightedGraph(int V) create an empty V-vertex graph
    EdgeWeightedGraph(In in) read graph from input stream
    int V() number of vertices
    int E() number of edges
    void addEdge(Edge e) add edge e to this graph
    Iterable<Edge> adj(int v) edges incident to v
    Iterable<Edge> edges() all of this graph's edges
    String toString() string representation
```

API for an edge-weighted graph

This API is very similar to the API for `Graph` (page 522). The two important differences are that it is based on `Edge` and that it adds the `edges()` method at right, which provides clients with the ability to iterate through to all the graph's edges (ignoring any self-loops). The rest of the implementation of `EdgeWeightedGraph` on page 611 is quite similar to the unweighted undirected graph implementation of SECTION 4.1, but instead of the adjacency lists of integers used in `Graph`, it uses adjacency lists of `Edge` objects.

The figure at the bottom of this page shows the edge-weighted graph representation that `EdgeWeightedGraph` builds from the sample file `tinyEWG.txt`, showing the contents of each `Bag` as a linked list to reflect the standard implementation of SECTION 1.3. To reduce clutter in the figure, we show each `Edge` as a pair of `int` values and a `double` value. The actual data structure is a linked list of links to objects containing those values. In particular, although there are two *references* to each `Edge` (one in the list for each vertex), there is only one `Edge` object corresponding to each graph edge. In the figure, the edges appear in each list in reverse order of the order they are processed, because of the stack-like nature of the standard linked-list implementation. As in `Graph`, by using a `Bag` we are making clear that our client code makes no assumptions about the order of objects in the lists.

```
public Iterable<Edge> edges()
{
    Bag<Edge> b = new Bag<Edge>();
    for (int v = 0; v < V; v++)
        for (Edge e : adj[v])
            if (e.other(v) > v) b.add(e);
    return b;
}
```

Gathering all the edges in an edge-weighted graph

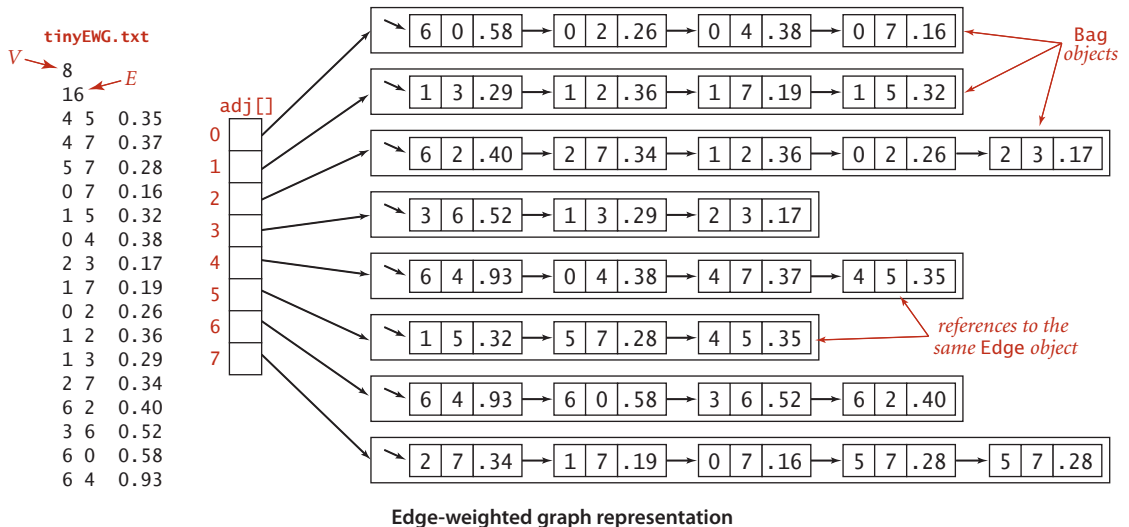

Weighted edge data type

```
public class Edge implements Comparable<Edge>
{
    private final int v;           // one vertex
    private final int w;           // the other vertex
    private final double weight;  // edge weight

    public Edge(int v, int w, double weight)
    {
        this.v = v;
        this.w = w;
        this.weight = weight;
    }

    public double weight()
    { return weight; }

    public int either()
    { return v; }

    public int other(int vertex)
    {
        if (vertex == v) return w;
        else if (vertex == w) return v;
        else throw new RuntimeException("Inconsistent edge");
    }

    public int compareTo(Edge that)
    {
        if (this.weight() < that.weight()) return -1;
        else if (this.weight() > that.weight()) return +1;
        else return 0;
    }

    public String toString()
    { return String.format("%d-%d %.2f", v, w, weight); }
}
```

This data type provides the methods `either()` and `other()` so that such clients can use `other(v)` to find the other vertex when it knows `v`. When neither vertex is known, our clients use the idiomatic code `int v = e.either(), w = e.other(v);` to access an `Edge e`'s two vertices.

Edge-weighted graph data type

```

public class EdgeWeightedGraph
{
    private final int V;           // number of vertices
    private int E;                 // number of edges
    private Bag<Edge>[] adj;      // adjacency lists

    public EdgeWeightedGraph(int V)
    {
        this.V = V;
        this.E = 0;
        adj = (Bag<Edge>[]) new Bag[V];
        for (int v = 0; v < V; v++)
            adj[v] = new Bag<Edge>();
    }

    public EdgeWeightedGraph(In in)
    // See Exercise 4.3.9.

    public int V() { return V; }
    public int E() { return E; }

    public void addEdge(Edge e)
    {
        int v = e.either(), w = e.other(v);
        adj[v].add(e);
        adj[w].add(e);
        E++;
    }

    public Iterable<Edge> adj(int v)
    { return adj[v]; }

    public Iterable<Edge> edges()
    // See page 609.
}

```

This implementation maintains a vertex-indexed array of lists of edges. As with `Graph` (see page 526), every edge appears twice: if an edge connects v and w , it appears both in v 's list and in w 's list. The `edges()` method puts all the edges in a `Bag` (see page 609). The `toString()` implementation is left as an exercise.

Comparing edges by weight. The API specifies that the `Edge` class must implement the `Comparable` interface and include a `compareTo()` implementation. The natural ordering for edges in an edge-weighted graph is by weight. Accordingly, the implementation of `compareTo()` is straightforward.

Parallel edges. As with our undirected-graph implementations, we allow parallel edges. Alternatively, we could develop a more complicated implementation of `EdgeWeightedGraph` that disallows them, perhaps keeping the minimum-weight edge from a set of parallel edges.

Self-loops. We allow self-loops. However, our `edges()` implementation in `EdgeWeightedGraph` does not include self-loops even though they might be present in the input or in the data structure. This omission has no effect on our MST algorithms because no MST contains a self-loop. When working with an application where self-loops are significant, you may need to modify our code as appropriate for the application.

OUR CHOICE TO USE explicit `Edge` objects leads to clear and compact client code, as you will see. It carries a small price: each adjacency-list node has a *reference* to an `Edge` object, with redundant information (all the nodes on v 's adjacency list have a v). We also pay object overhead cost. Although we have only one copy of each `Edge`, we do have two references to each `Edge` object. An alternative and widely used approach is to keep two list nodes corresponding to each edge, just as in `Graph`, each with a vertex and the edge weight in each list node. This alternative also carries a price—two nodes, including two copies of the weight for each edge.

MST API and test client As usual, for graph processing, we define an API where the constructor takes an edge-weighted graph as argument and supports client query methods that return the MST and its weight. How should we represent the MST itself? The MST of a graph G is a subgraph of G that is also a tree, so we have numerous options. Chief among them are

- A list of edges
- An edge-weighted graph
- A vertex-indexed array with parent links

To give clients and our implementations as much flexibility as possible in choosing among these alternatives for various applications, we adopt the following API:

```
public class MST
    MST(EdgeWeightedGraph G)      constructor
    Iterable<Edge> edges()        all of the MST edges
    double weight()              weight of MST
```

API for MST implementations

Test client. As usual, we create sample graphs and develop a test client for use in testing our implementations. A sample client is shown below. It reads edges from the input stream, builds an edge-weighted graph, computes the MST of that graph, prints the MST edges, and prints the total weight of the MST.

```
public static void main(String[] args)
{
    In in = new In(args[0]);
    EdgeWeightedGraph G;
    G = new EdgeWeightedGraph(in);

    MST mst = new MST(G);
    for (Edge e : mst.edges())
        StdOut.println(e);
    StdOut.println(mst.weight());
}
```

MST test client

Test data. You can find the file `tinyEWG.txt` on the booksite, which defines the small sample graph on page 604 that we use for detailed traces of MST algorithms. You can also find on the booksite the file `mediumEWG.txt`, which defines the weighted graph with 250 vertices that is drawn on bottom of the the facing page. It is an example of a *Euclidean graph*, whose vertices are points in the plane and whose edges are lines connecting them with weights equal to their Euclidean distances. Such graphs are useful for gaining insight into the behavior of MST algorithms, and they also model many of the typical practical problems we have mentioned, such as road maps or electric circuits. You can also find on the booksite is a larger example `largeEWG.txt` that defines a Euclidean graph with 1 million vertices. Our goal is to be able to find the MST of such a graph in a reasonable amount of time.

```
% more tinyEWG.txt
8 16
4 5 .35
4 7 .37
5 7 .28
0 7 .16
1 5 .32
0 4 .38
2 3 .17
1 7 .19
0 2 .26
1 2 .36
1 3 .29
2 7 .34
6 2 .40
3 6 .52
6 0 .58
6 4 .93

% java MST tinyEWG.txt
0-7 0.16
1-7 0.19
0-2 0.26
2-3 0.17
5-7 0.28
4-5 0.35
6-2 0.40
1.81
```

```
% more mediumEWG.txt
250 1273
244 246 0.11712
239 240 0.10616
238 245 0.06142
235 238 0.07048
233 240 0.07634
232 248 0.10223
231 248 0.10699
229 249 0.10098
228 241 0.01473
226 231 0.07638
... [1263 more edges ]

% java MST mediumEWG.txt
0 225 0.02383
49 225 0.03314
44 49 0.02107
44 204 0.01774
49 97 0.03121
202 204 0.04207
176 202 0.04299
176 191 0.02089
68 176 0.04396
58 68 0.04795
... [239 more edges ]
10.46351
```

graph

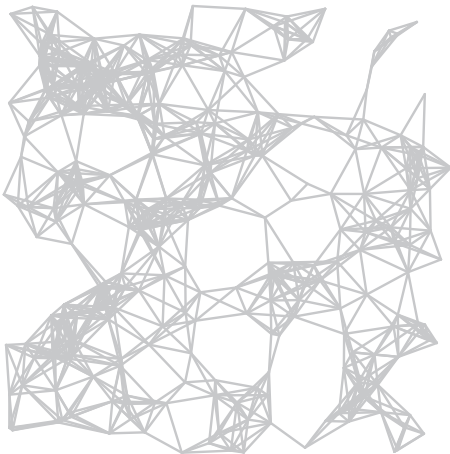

MST

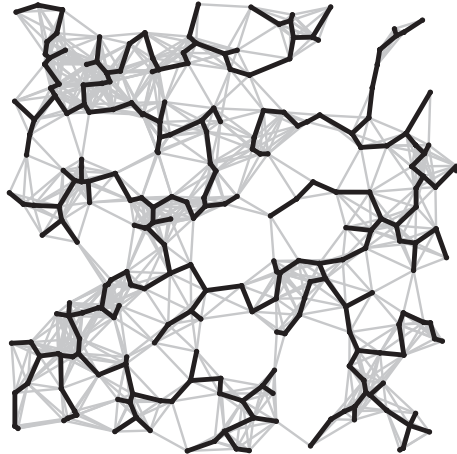

A 250-node Euclidean graph (with 1,273 edges) and its MST

Prim's algorithm Our first MST method, known as *Prim's algorithm*, is to attach a new edge to a single growing tree at each step. Start with any vertex as a single-vertex tree; then add $V-1$ edges to it, always taking next (coloring black) the minimum-weight edge that connects a vertex on the tree to a vertex not yet on the tree (a crossing edge for the cut defined by tree vertices).

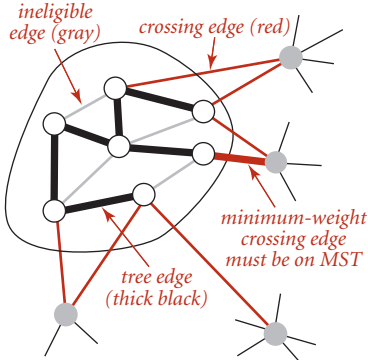

Prim's MST algorithm

Proposition L. Prim's algorithm computes the MST of any connected edge-weighted graph.

Proof: Immediate from PROPOSITION K. The growing tree defines a cut with no black edges; the algorithm takes the crossing edge of minimal weight, so it is successively coloring edges black in accordance with the greedy algorithm.

The one-sentence description of Prim's algorithm just given leaves unanswered a key question: How do we (efficiently) find the crossing edge of minimal weight? Several methods have been proposed—we will discuss some of them after we have developed a full solution based on a particularly simple approach.

Data structures. We implement Prim's algorithm with the aid of a few simple and familiar data structures. In particular, we represent the vertices on the tree, the edges on the tree, and the crossing edges, as follows:

- *Vertices on the tree:* We use a vertex-indexed boolean array `marked[]`, where `marked[v]` is `true` if `v` is on the tree.
- *Edges on the tree:* We use one of two data structures: a queue `mst` to collect MST edges or a vertex-indexed array `edgeTo[]` of `Edge` objects, where `edgeTo[v]` is the `Edge` that connects `v` to the tree.
- *Crossing edges:* We use a `MinPQ<Edge>` priority queue that compares edges by weight (see page 610).

These data structures allow us to directly answer the basic question “Which is the minimal-weight crossing edge?”

Maintaining the set of crossing edges. Each time that we add an edge to the tree, we also add a vertex to the tree. To maintain the set of crossing edges, we need to add to the priority queue all edges from that vertex to any non-tree vertex (using `marked[]` to identify such edges). But we must do more: any edge connecting the vertex just added to a tree vertex that is already on the priority queue now becomes *ineligible* (it is no longer a crossing edge because it connects two tree vertices). An *eager* implementation

of Prim's algorithm would remove such edges from the priority queue; we first consider a simpler *lazy* implementation of the algorithm where we leave such edges on the priority queue, deferring the eligibility test to when we remove them.

The figure at right is a trace for our small sample graph `tinyEWG.txt`. Each drawing depicts the graph and the priority queue just after a vertex is visited (added to the tree and the edges in its adjacency list processed). The contents of the priority queue are shown in order on the side, with new edges marked with asterisks. The algorithm builds the MST as follows:

- Adds 0 to the MST and all edges in its adjacency list to the priority queue.
- Adds 7 and 0-7 to the MST and all edges in its adjacency list to the priority queue.
- Adds 1 and 1-7 to the MST and all edges in its adjacency list to the priority queue.
- Adds 2 and 0-2 to the MST and edges 2-3 and 6-2 to the priority queue. Edges 2-7 and 1-2 become ineligible.
- Adds 3 and 2-3 to the MST and edge 3-6 to the priority queue. Edge 1-3 becomes ineligible.
- Removes ineligible edges 1-3, 1-5, and 2-7 from the priority queue.
- Adds 5 and 5-7 to the MST and edge 4-5 to the priority queue. Edge 1-5 becomes ineligible.
- Adds 4 and 4-5 to the MST and edge 6-4 to the priority queue. Edges 4-7 and 0-4 become ineligible.
- Removes ineligible edges 1-2, 4-7, and 0-4 from the priority queue.
- Adds 6 and 6-2 to the MST. The other edges incident to 6 become ineligible.

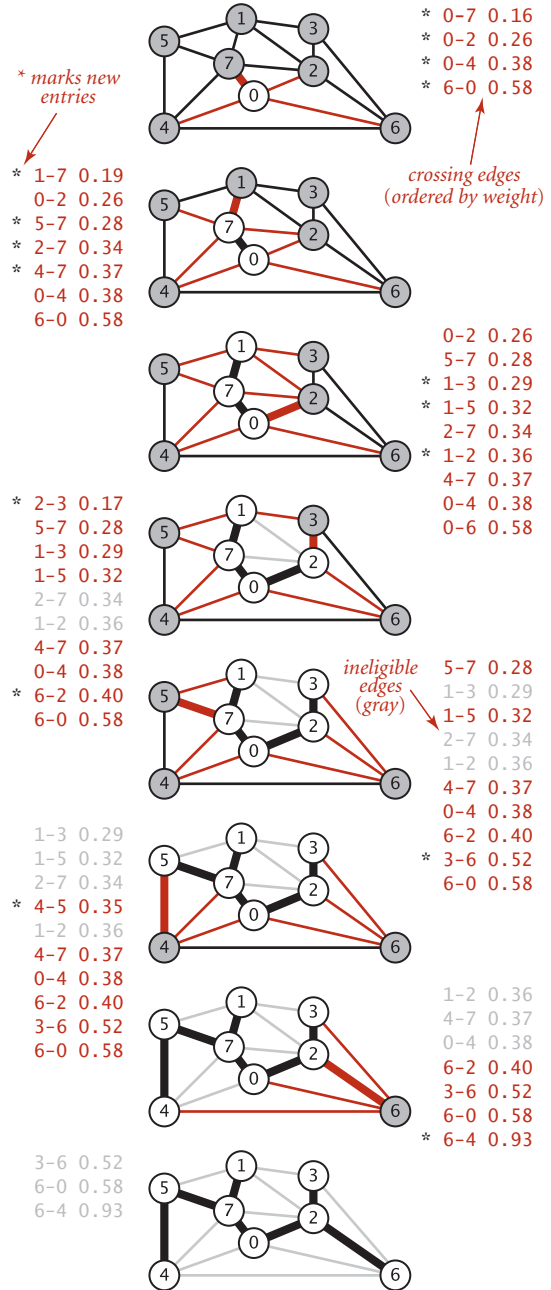

Trace of Prim's algorithm (lazy version)

After having added V vertices (and $V-1$ edges), the MST is complete. The remaining edges on the priority queue are ineligible, so we need not examine them again.

Implementation. With these preparations, implementing Prim's algorithm is straightforward, as shown in the implementation `LazyPrimMST` on the facing page. As with our depth-first search and breadth-first search implementations in the previous two sections, it computes the MST in the constructor so that client methods can learn properties of the MST with query methods. We use a private method `visit()` that puts a vertex on the tree, by marking it as visited and then putting all of its incident edges that are not ineligible onto the priority queue, thus ensuring that the priority queue contains the crossing edges from tree vertices to non-tree vertices (perhaps also some ineligible edges). The inner loop is a rendition in code of the one-sentence description of the algorithm: we take an edge from the priority queue and (if it is not ineligible) add it to the tree, and also add to the tree the new vertex that it leads to, updating the set of crossing edges by calling `visit()` with that vertex as argument. The `weight()` method requires iterating through the tree edges to add up the edge weights (lazy approach) or keeping a running total in an instance variable (eager approach) and is left as EXERCISE 4.3.31.

Running time. How fast is Prim's algorithm? This question is not difficult to answer, given our knowledge of the behavior characteristics of priority queues:

Proposition M. The lazy version of Prim's algorithm uses space proportional to E and time proportional to $E \log E$ (in the worst case) to compute the MST of a connected edge-weighted graph with E edges and V vertices.

Proof: The bottleneck in the algorithm is the number of edge-weight comparisons in the priority-queue methods `insert()` and `delMin()`. The number of edges on the priority queue is at most E , which gives the space bound. In the worst case, the cost of an insertion is $\sim \lg E$ and the cost to delete the minimum is $\sim 2 \lg E$ (see PROPOSITION O in CHAPTER 2). Since at most E edges are inserted and at most E are deleted, the time bound follows.

In practice, the upper bound on the running time is a bit conservative because the number of edges on the priority queue is typically much less than E . The existence of such a simple, efficient, and useful algorithm for such a challenging task is quite remarkable. Next, we briefly discuss some improvements. As usual, detailed evaluation of such improvements in performance-critical applications is a job for experts.

Lazy version of Prim's MST algorithm

```

public class LazyPrimMST
{
    private boolean[] marked;           // MST vertices
    private Queue<Edge> mst;           // MST edges
    private MinPQ<Edge> pq;           // crossing (and ineligible) edges

    public LazyPrimMST(EdgeWeightedGraph G)
    {
        pq = new MinPQ<Edge>();
        marked = new boolean[G.V()];
        mst = new Queue<Edge>();

        visit(G, 0); // assumes G is connected (see Exercise 4.3.22)
        while (!pq.isEmpty())
        {
            Edge e = pq.delMin(); // Get lowest-weight
            int v = e.either(), w = e.other(v); // edge from pq.
            if (marked[v] && marked[w]) continue; // Skip if ineligible.
            mst.enqueue(e); // Add edge to tree.
            if (!marked[v]) visit(G, v); // Add vertex to tree
            if (!marked[w]) visit(G, w); // (either v or w).
        }
    }

    private void visit(EdgeWeightedGraph G, int v)
    { // Mark v and add to pq all edges from v to unmarked vertices.
        marked[v] = true;
        for (Edge e : G.adj(v))
            if (!marked[e.other(v)]) pq.insert(e);
    }

    public Iterable<Edge> edges()
    { return mst; }

    public double weight() // See Exercise 4.3.31.
}

```

This implementation of Prim's algorithm uses a priority queue to hold crossing edges, a vertex-indexed arrays to mark tree vertices, and a queue to hold MST edges. This implementation is a lazy approach where we leave ineligible edges in the priority queue.

Eager version of Prim’s algorithm To improve the LazyPrimMST, we might try to delete ineligible edges from the priority queue, so that the priority queue contains *only* the crossing edges between tree vertices and non-tree vertices. But we can eliminate even more edges. The key is to note that our only interest is in the *minimal* edge from each non-tree vertex to a tree vertex. When we add a vertex v to the tree, the only possible change with respect to each non-tree vertex w is that adding v brings w closer than before to the tree. In short, we do not need to keep on the priority queue *all* of the edges from w to tree vertices—we just need to keep track of the minimum-weight edge and check whether the addition of v to the tree necessitates that we update that minimum (because of an edge v - w that has lower weight), which we can do as we process each edge in v ’s adjacency list. In other words, we

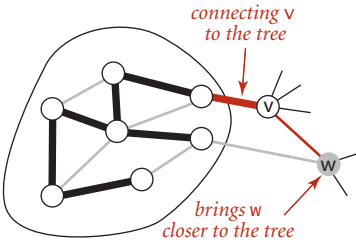

maintain on the priority queue just *one* edge for each non-tree vertex w : the shortest edge that connects it to the tree. Any longer edge connecting w to the tree will become ineligible at some point, so there is no need to keep it on the priority queue.

PrimMST (ALGORITHM 4.7 on page 622) implements Prim’s algorithm using our index priority queue data type from SECTION 2.4 (see page 320). It replaces the data structures `marked[]` and `mst[]` in LazyPrimMST by two vertex-indexed arrays `edgeTo[]` and `distTo[]`, which have the following properties:

- If v is not on the tree but has at least one edge connecting it to the tree, then `edgeTo[v]` is the shortest edge connecting v to the tree, and `distTo[v]` is the weight of that edge.
- All such vertices v are maintained on the index priority queue, as an index v associated with the weight of `edgeTo[v]`.

The key implications of these properties is that *the minimum key on the priority queue is the weight of the minimal-weight crossing edge, and its associated vertex v is the next to add to the tree*. The `marked[]` array is not needed, since the condition `!marked[w]` is equivalent to the condition that `distTo[w]` is infinite (and that `edgeTo[w]` is `null`). To maintain the data structures, PrimMST takes an edge v from the priority queue, then checks each edge v - w on its adjacency list. If w is marked, the edge is ineligible; if it is not on the priority queue or its weight is lower than the current best-known `edgeTo[w]`, the code updates the data structures to establish v - w as the best-known way to connect v to the tree.

The figure on the facing page is a trace of PrimMST for our small sample graph `tinyEWG.txt`. The contents of the `edgeTo[]` and `distTo[]` arrays are depicted after each vertex is added to the MST, color-coded to depict the MST vertices (index in black), the non-MST vertices (index in gray), the MST edges (in black), and the priority-queue

index/value pairs (in red). In the drawings, the shortest edge connecting each non-MST vertex to an MST vertex is drawn in red. The algorithm adds edges to the MST in the same order as the lazy version; the difference is in the priority-queue operations. It builds the MST as follows:

- Adds 0 to the MST and all edges in its adjacency list to the priority queue, since each such edge is the best (only) known connection between a tree vertex and a non-tree vertex.
- Adds 7 and 0-7 to the MST and 1-7 and 5-7 to the priority queue. Edges 4-7 and 2-7 do not affect the priority queue because their weights are not less than the weights of the known connections from the MST to 4 and 2, respectively.
- Adds 1 and 1-7 to the MST and 1-3 to the priority queue.
- Adds 2 and 0-2 to the MST, replaces 0-6 with 2-6 as the shortest edge from a tree vertex to 6, and replaces 1-3 with 2-3 as the shortest edge from a tree vertex to 3.
- Adds 3 and 2-3 to the MST.
- Adds 5 and 5-7 to the MST and replaces 0-4 with 4-5 as the shortest edge from a tree vertex to 4.
- Adds 4 and 4-5 to the MST.
- Adds 6 and 6-2 to the MST.

After having added $V-1$ edges, the MST is complete and the priority queue is empty.

AN ESSENTIALLY IDENTICAL ARGUMENT as in the proof of PROPOSITION M proves that the eager version of Prim's algorithm finds the

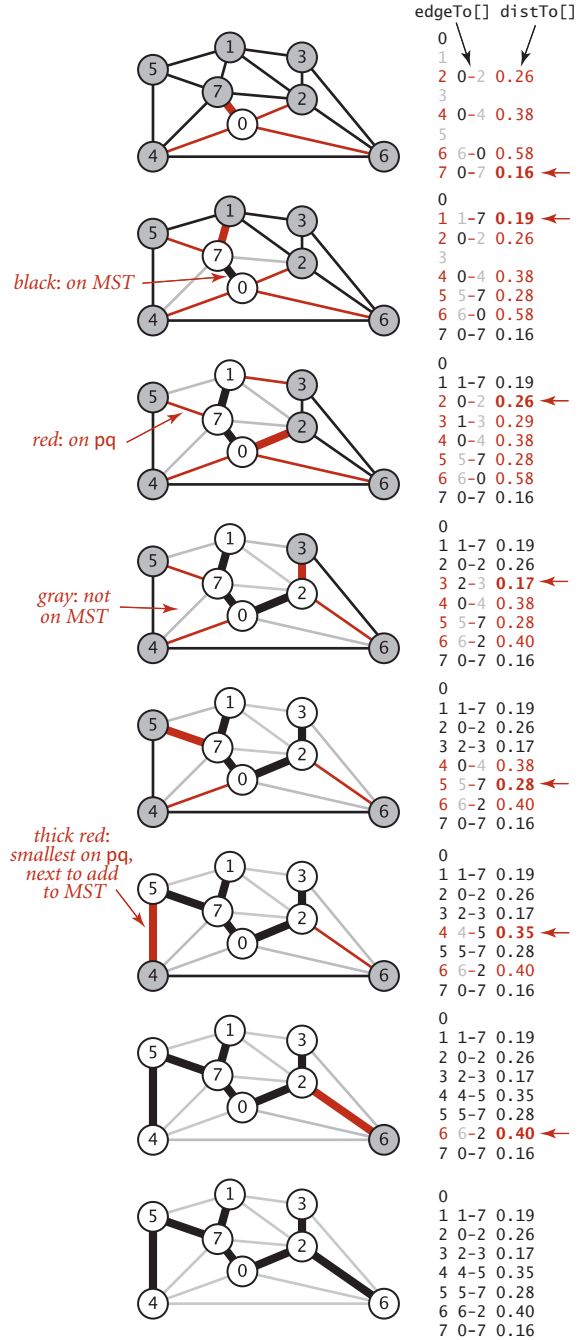

Trace of Prim's algorithm (eager version)

ALGORITHM 4.7 Prim's MST algorithm (eager version)

```

public class PrimMST
{
    private Edge[] edgeTo;           // shortest edge from tree vertex
    private double[] distTo;        // distTo[w] = edgeTo[w].weight()
    private boolean[] marked;      // true if v on tree
    private IndexMinPQ<Double> pq;  // eligible crossing edges

    public PrimMST(EdgeWeightedGraph G)
    {
        edgeTo = new Edge[G.V()];
        distTo = new double[G.V()];
        marked = new boolean[G.V()];
        for (int v = 0; v < G.V(); v++)
            distTo[v] = Double.POSITIVE_INFINITY;
        pq = new IndexMinPQ<Double>(G.V());

        distTo[0] = 0.0;
        pq.insert(0, 0.0);           // Initialize pq with 0, weight 0.
        while (!pq.isEmpty())
            visit(G, pq.delMin());  // Add closest vertex to tree.
    }

    private void visit(EdgeWeightedGraph G, int v)
    { // Add v to tree; update data structures.
        marked[v] = true;
        for (Edge e : G.adj(v))
        {
            int w = e.other(v);
            if (marked[w]) continue; // v-w is ineligible.
            if (e.weight() < distTo[w])
            { // Edge e is new best connection from tree to w.
                edgeTo[w] = e;
                distTo[w] = e.weight();
                if (pq.contains(w)) pq.change(w, distTo[w]);
                else pq.insert(w, distTo[w]);
            }
        }
    }

    public Iterable<Edge> edges() // See Exercise 4.3.21.
    public double weight()       // See Exercise 4.3.31.
}

```

This implementation of Prim's algorithm keeps eligible crossing edges on an index priority queue.

MST of a connected edge-weighted graph in time proportional to $E \log V$ and extra space proportional to V (see page 623). For the huge sparse graphs that are typical in practice, there is no asymptotic difference in the time bound (because $\lg E \sim \lg V$ for sparse graphs); the space bound is a constant-factor (but significant) improvement. Further analysis and experimentation are best left for experts facing performance-critical applications, where many factors come into play, including the implementations of `MinPQ` and `IndexMinPQ`, the graph representation, properties of the application's graph model, and so forth. As usual, such improvements need to be carefully considered, as the increased code complexity is only justified for applications where constant-factor performance gains are important, and might even be counterproductive on complex modern systems.

Proposition N. The eager version of Prim's algorithm uses extra space proportional to V and time proportional to $E \log V$ (in the worst case) to compute the MST of a connected edge-weighted graph with E edges and V vertices.

Proof: The number of edges on the priority queue is at most V , and there are three vertex-indexed arrays, which implies the space bound. The algorithm uses V *insert* operations, V *delete the minimum* operations, and (in the worst case) E *change priority* operations. These counts, coupled with the fact that our heap-based implementation of the index priority queue implements all these operations in time proportional to $\log V$ (see page 321), imply the time bound.

The diagram at right shows Prim's algorithm in operation on our 250-vertex Euclidean graph `mediumEWG.txt`. It is a fascinating dynamic process (see also `EXERCISE 4.3.27`). Most often the tree grows by connecting a new vertex to the vertex just added. When reaching an area with no nearby non-tree vertices, the growth starts from another part of the tree.

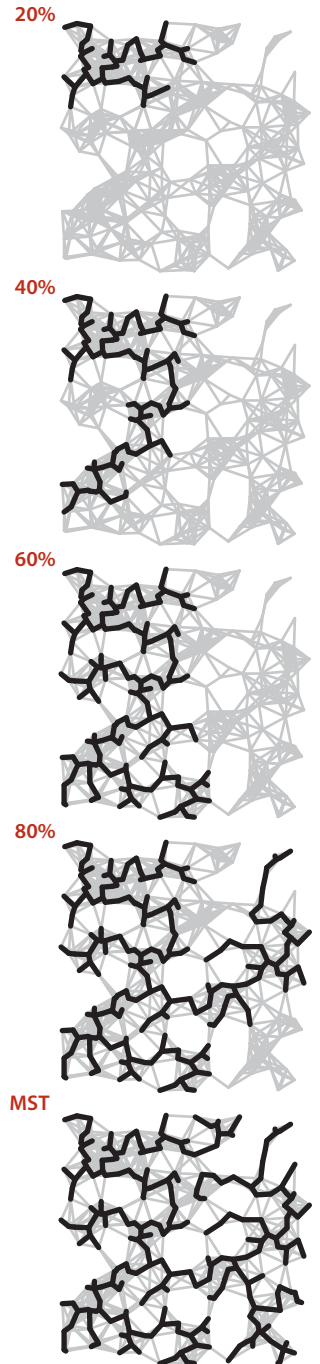

Prim's algorithm (250 vertices)

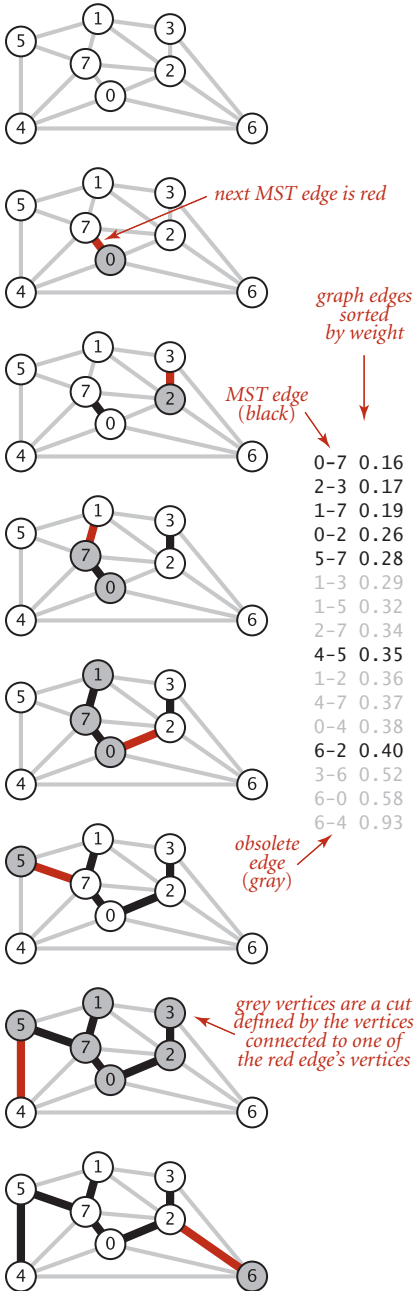

Trace of Kruskal's algorithm

Kruskal's algorithm The second MST algorithm that we consider in detail is to process the edges in order of their weight values (smallest to largest), taking for the MST (coloring black) each edge that does not form a cycle with edges previously added, stopping after adding $V-1$ edges have been taken. The black edges form a forest of trees that evolves gradually into a single tree, the MST. This method is known as *Kruskal's algorithm*:

Proposition O. Kruskal's algorithm computes the MST of any edge-weighted connected graph.

Proof: Immediate from PROPOSITION K. If the next edge to be considered does not form a cycle with black edges, it crosses a cut defined by the set of vertices connected to one of the edge's vertices by tree edges (and its complement). Since the edge does not create a cycle, it is the only crossing edge seen so far, and since we consider the edges in sorted order, it is a crossing edge of minimum weight. Thus, the algorithm is successively taking a minimal-weight crossing edge, in accordance with the greedy algorithm.

Prim's algorithm builds the MST one edge at a time, finding a new edge to attach to a single growing tree at each step. Kruskal's algorithm also builds the MST one edge at a time; but, by contrast, it finds an edge that connects two trees in a forest of growing trees. We start with a degenerate forest of V single-vertex trees and perform the operation of combining two trees (using the shortest edge possible) until there is just one tree left: the MST.

The figure at left shows a step-by-step example of the operation of Kruskal's algorithm on `tinyEWG.txt`. The five lowest-weight edges in the graph are taken for the MST, then 1-3, 1-5, and 2-7 are determined to be ineligible before 4-5 is taken for the MST, and finally 1-2, 4-7, and 0-4 are determined to be ineligible and 6-2 is taken for the MST.

Kruskal's algorithm is also not difficult to implement, given the basic algorithmic tools that we have considered in this book: we use a priority queue (SECTION 2.4) to consider the edges in order by weight, a union-find data structure (SECTION 1.5) to identify those that cause cycles, and a queue (SECTION 1.3) to collect the MST edges. ALGORITHM 4.8 is an implementation along these lines. Note that collecting the MST edges in a Queue means that when a client iterates through the edges it gets them in increasing order of their weight. The `weight()` method requires iterating through the queue to add the edge weights (or keeping a running total in an instance variable) and is left as an exercise (see EXERCISE 4.3.31).

Analyzing the running time of Kruskal's algorithm is a simple matter because we know the running times of its basic operations.

Proposition N (continued). Kruskal's algorithm uses space proportional to E and time proportional to $E \log E$ (in the worst case) to compute the MST of an edge-weighted connected graph with E edges and V vertices.

Proof: The implementation uses the priority-queue constructor that initializes the priority queue with all the edges, at a cost of at most E compares (see SECTION 2.4). After the priority queue is built, the argument is the same as for Prim's algorithm. The number of edges on the priority queue is at most E , which gives the space bound, and the cost per operation is at most $2 \lg E$ compares, which gives the time bound. Kruskal's algorithm also performs up to E `find()` and V `union()` operations, but that cost does not contribute to the $E \log E$ order of growth of the total running time (see SECTION 1.5).

As with Prim's algorithm the cost bound is conservative, since the algorithm terminates after finding the $V-1$ MST edges. The order of growth of the actual cost is $E + E_0 \log E$, where E_0 is the number of edges whose weight is less than the weight of the MST edge with the highest weight. Despite this advantage, Kruskal's algorithm is generally slower than Prim's algorithm because it has to do a `connected()` operation for each edge, in addition to the priority-queue operations that both algorithms do for each edge processed (see EXERCISE 4.3.39).

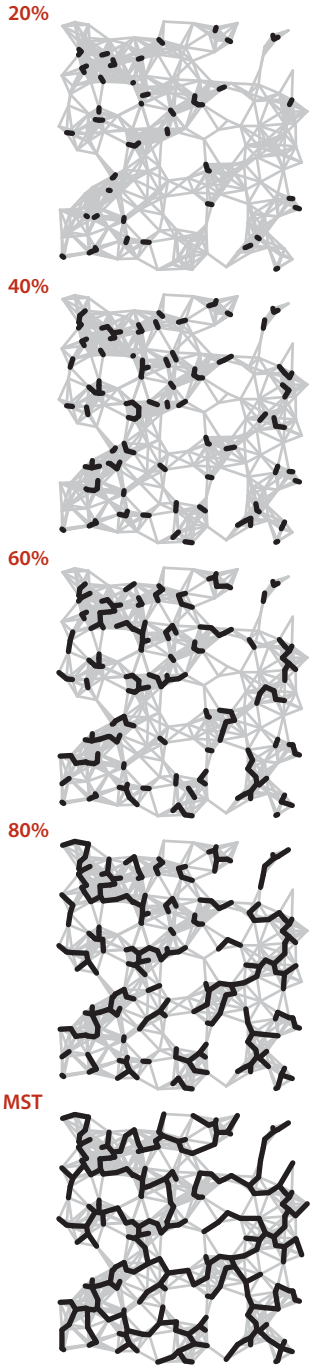

Kruskal's algorithm (250 vertices)

The figure at left illustrates the algorithm's dynamic characteristics on the larger example `mediumEWG.txt`. The fact that the edges are added to the forest in order of their length is quite apparent.

ALGORITHM 4.8 Kruskal's MST algorithm

```

public class KruskalMST
{
    private Queue<Edge> mst;

    public KruskalMST(EdgeWeightedGraph G)
    {
        mst = new Queue<Edge>();
        MinPQ<Edge> pq = new MinPQ<Edge>(G.edges());
        UF uf = new UF(G.V());

        while (!pq.isEmpty() && mst.size() < G.V()-1)
        {
            Edge e = pq.delMin();           // Get min weight edge on pq
            int v = e.either(), w = e.other(v); // and its vertices.
            if (uf.connected(v, w)) continue; // Ignore ineligible edges.
            uf.union(v, w);                 // Merge components.
            mst.enqueue(e);                 // Add edge to mst.
        }
    }

    public Iterable<Edge> edges()
    { return mst; }

    public double weight()                // See Exercise 4.3.31.
}

```

This implementation of Kruskal's algorithm uses a queue to hold MST edges, a priority queue to hold edges not yet examined, and a union-find data structure for identifying ineligible edges. The MST edges are returned to the client in increasing order of their weights. The `weight()` method is left as an exercise.

```

% java KruskalMST tinyEWG.txt
0-7 0.16
2-3 0.17
1-7 0.19
0-2 0.26
5-7 0.28
4-5 0.35
6-2 0.40
1.81

```

Perspective The MST problem is one of the most heavily studied problems that we encounter in this book. Basic approaches to solving it were invented long before the development of modern data structures and modern techniques for analyzing the performance of algorithms, at a time when finding the MST of a graph that contained, say, thousands of edges was a daunting task. The MST algorithms that we have considered differ from these old ones essentially in their use and implementation of modern algorithms and data structures for basic tasks, which (coupled with modern computing power) makes it possible for us to compute MSTs with millions or even billions of edges.

Historical notes. An MST implementation for dense graphs (see EXERCISE 4.3.29) was first presented by R. Prim in 1961 and, independently, by E. W. Dijkstra soon thereafter. It is usually referred to as *Prim's algorithm*, although Dijkstra's presentation was more general. But the basic idea was also presented by V. Jarnik in 1939, so some authors refer to the method as *Jarnik's algorithm*, thus characterizing Prim's (or Dijkstra's) role as finding an efficient implementation of the algorithm for dense graphs. As the priority-queue ADT came into use in the early 1970s, its application to finding MSTs of sparse

graphs was straightforward; the fact that MSTs of sparse graphs could be computed in time proportional to $E \log E$ became widely known without attribution to any particular researcher. In 1984, M. L. Fredman and R. E. Tarjan developed the *Fibonacci heap* data structure, which improves the theoretical bound on the order of growth of the running time of Prim's algorithm to $E + V \log V$. J. Kruskal presented his algorithm in 1956, but, again, the relevant ADT implementations were not carefully studied for many years. Other interesting historical notes are that Kruskal's paper mentioned a version of Prim's algorithm and that a 1926 (!) paper by O. Boruvka mentioned both approaches. Boruvka's paper addressed a power-distribution application and introduced yet another method that is easily implemented with modern data structures (see EXERCISE 4.3.43 and EXERCISE 4.3.44). The method was rediscovered by M. Sollin in 1961;

algorithm	worst-case order of growth for V vertices and E edges	
	space	time
<i>lazy Prim</i>	E	$E \log E$
<i>eager Prim</i>	V	$E \log V$
<i>Kruskal</i>	E	$E \log E$
<i>Fredman-Tarjan</i>	V	$E + V \log V$
<i>Chazelle</i>	V	<i>very, very nearly, but not quite E</i>
<i>impossible?</i>	V	$E?$

Performance characteristics of MST algorithms

it later attracted attention as the basis for MST algorithms with efficient asymptotic performance and as the basis for parallel MST algorithms.

A linear-time algorithm? On the one hand, no theoretical results have been developed that deny the existence of an MST algorithm that is guaranteed to run in linear time for all graphs. On the other hand, the goal of developing algorithms for computing the MST of sparse graphs in linear time remains elusive. Since the 1970s the applicability of the union-find abstraction to Kruskal's algorithm and the applicability of the priority-queue abstraction to Prim's algorithm have been prime motivations for many researchers to seek better implementations of those ADTs. Many researchers have concentrated on finding efficient priority-queue implementations as the key to finding efficient MST algorithms for sparse graphs; many other researchers have studied variations of Boruvka's algorithm as the basis for nearly linear-time MST algorithms for sparse graphs. Such research still holds the potential to lead us eventually to a practical linear-time MST algorithm and has even shown the existence of a randomized linear-time algorithm. Also, researchers are getting quite close to the linear-time goal: B. Chazelle exhibited an algorithm in 1997 that certainly could never be distinguished from a linear-time algorithm in any conceivable practical situation (even though it is provably nonlinear), but is so complicated that no one would use it in practice. While the algorithms that have emerged from such research are generally quite complicated, simplified versions of some of them may yet be shown to be useful in practice. In the meantime, we can use the basic algorithms that we have considered here to compute the MST in linear time in most practical situations, perhaps paying an extra factor of $\log V$ for some sparse graphs.

IN SUMMARY, we can consider the MST problem to be "solved" for practical purposes. For most graphs, the cost of finding the MST is only slightly higher than the cost of extracting the graph's edges. This rule holds except for huge graphs that are extremely sparse, but the available performance improvement over the best-known algorithms even in this case is a small constant factor, perhaps a factor of 10 at best. These conclusions are borne out for many graph models, and practitioners have been using Prim's and Kruskal's algorithms to find MSTs in huge graphs for decades.

Q&A

Q. Do Prim's and Kruskal's algorithms work for *directed* graphs?

A. No, not at all. That is a more difficult graph-processing problem known as the *minimum cost arborescence* problem.

EXERCISES

4.3.1 Prove that you can rescale the weights by adding a positive constant to all of them or by multiplying them all by a positive constant without affecting the MST.

4.3.2 Draw all of the MSTs of the graph depicted at right (all edge weights are equal).

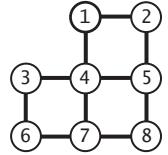

4.3.3 Show that if a graph's edges all have distinct weights, the MST is unique.

4.3.4 Consider the assertion that an edge-weighted graph has a unique MST *only* if its edge weights are distinct. Give a proof or a counterexample.

4.3.5 Show that the greedy algorithm is valid even when edge weights are not distinct.

4.3.6 Give the MST of the weighted graph obtained by deleting vertex 7 from `tinyEWG.txt` (see page 604).

4.3.7 How would you find a *maximum* spanning tree of an edge-weighted graph?

4.3.8 Prove the following, known as the *cycle property*: Given any cycle in an edge-weighted graph (all edge weights distinct), the edge of maximum weight in the cycle does not belong to the MST of the graph.

4.3.9 Implement the constructor for `EdgeWeightedGraph` that reads a graph from the input stream, by suitably modifying the constructor from `Graph` (see page 526).

4.3.10 Develop an `EdgeWeightedGraph` implementation for dense graphs that uses an adjacency-matrix (two-dimensional array of weights) representation. Disallow parallel edges.

4.3.11 Determine the amount of memory used by `EdgeWeightedGraph` to represent a graph with V vertices and E edges, using the memory-cost model of SECTION 1.4.

4.3.12 Suppose that a graph has distinct edge weights. Does its shortest edge have to belong to the MST? Can its longest edge belong to the MST? Does a min-weight edge on every cycle have to belong to the MST? Prove your answer to each question or give a counterexample.

4.3.13 Give a counterexample that shows why the following strategy does not necessarily find the MST: 'Start with any vertex as a single-vertex MST, then add $V-1$ edges to it, always taking next a min-weight edge incident to the vertex most recently added

EXERCISES *(continued)*

to the MST:

4.3.14 Given an MST for an edge-weighted graph G , suppose that an edge in G that does not disconnect G is deleted. Describe how to find an MST of the new graph in time proportional to E .

4.3.15 Given an MST for an edge-weighted graph G and a new edge e , describe how to find an MST of the new graph in time proportional to V .

4.3.16 Given an MST for an edge-weighted graph G and a new edge e , write a program that determines the range of weights for which e is in an MST.

4.3.17 Implement `toString()` for `EdgeWeightedGraph`.

4.3.18 Give traces that show the process of computing the MST of the graph defined in EXERCISE 4.3.6 with the lazy version of Prim's algorithm, the eager version of Prim's algorithm, and Kruskal's algorithm.

4.3.19 Suppose that you use a priority-queue implementation that maintains a sorted list. What would be the order of growth of the worst-case running time for Prim's algorithm and for Kruskal's algorithm for graphs with V vertices and E edges? When would this method be appropriate, if ever? Defend your answer.

4.3.20 True or false: At any point during the execution of Kruskal's algorithm, each vertex is closer to some vertex in its subtree than to any vertex not in its subtree. Prove your answer.

4.3.21 Provide an implementation of `edges()` for `PrimMST` (page 622).

Solution:

```
public Iterable<Edge> edges()
{
    Bag<Edge> mst = new Bag<Edge>();
    for (int v = 1; v < edgeTo.length; v++)
        mst.add(edgeTo[v]);
    return mst;
}
```

CREATIVE PROBLEMS

4.3.22 *Minimum spanning forest.* Develop versions of Prim’s and Kruskal’s algorithms that compute the minimum spanning *forest* of an edge-weighted graph that is not necessarily connected. Use the connected-components API of SECTION 4.1 and find MSTs in each component.

4.3.23 *Vyssotsky’s algorithm.* Develop an implementation that computes the MST by applying the cycle property (see EXERCISE 4.3.8) repeatedly: Add edges one at a time to a putative tree, deleting a maximum-weight edge on the cycle if one is formed. *Note:* This method has received less attention than the others that we consider because of the comparative difficulty of maintaining a data structure that supports efficient implementation of the “delete the maximum-weight edge on the cycle” operation.

4.3.24 *Reverse-delete algorithm.* Develop an implementation that computes the MST as follows: Start with a graph containing all of the edges. Then repeatedly go through the edges in decreasing order of weight. For each edge, check if deleting that edge will disconnect the graph; if not, delete it. Prove that this algorithm computes the MST. What is the order of growth of the number of edge-weight compares performed by your implementation?

4.3.25 *Worst-case generator.* Develop a reasonable generator for edge-weighted graphs with V vertices and E edges such that the running time of the lazy version of Prim’s algorithm is nonlinear. Answer the same question for the eager version.

4.3.26 *Critical edges.* An MST edge whose deletion from the graph would cause the MST weight to increase is called a *critical edge*. Show how to find all critical edges in a graph in time proportional to $E \log E$. *Note:* This question assumes that edge weights are not necessarily distinct (otherwise all edges in the MST are critical).

4.3.27 *Animations.* Write a client program that does dynamic graphical animations of MST algorithms. Run your program for `mediumEWG.txt` to produce images like the figures on page 621 and page 624.

4.3.28 *Space-efficient data structures.* Develop an implementation of the lazy version of Prim’s algorithm that saves space by using lower-level data structures for `EdgeWeightedGraph` and for `MinPQ` instead of `Bag` and `Edge`. Estimate the amount of memory saved as a function of V and E , using the memory-cost model of SECTION 1.4 (see EXERCISE 4.3.11).

CREATIVE PROBLEMS *(continued)*

4.3.29 *Dense graphs.* Develop an implementation of Prim's algorithm that uses an eager approach (but not a priority queue) and computes the MST using V^2 edge-weight comparisons.

4.3.30 *Euclidean weighted graphs.* Modify your solution to EXERCISE 4.1.37 to create an API `EuclideanEdgeWeightedGraph` for graphs whose vertices are points in the plane, so that you can work with graphical representations.

4.3.31 *MST weights.* Develop implementations of `weight()` for `LazyPrimMST`, `PrimMST`, and `KruskalMST`, using a *lazy* strategy that iterates through the MST edges when the client calls `weight()`. Then develop alternate implementations that use an *eager* strategy that maintains a running total as the MST is computed.

4.3.32 *Specified set.* Given a connected edge-weighted graph G and a specified set of edges S (having no cycles), describe a way to find a minimum-weight spanning tree of G that contains all the edges in S .

4.3.33 *Certification.* Write an MST and `EdgeWeightedGraph` client `check()` that uses the following *cut optimality conditions* implied by PROPOSITION J to verify that a proposed set of edges is in fact an MST: A set of edges is an MST if it is a spanning tree and every edge is a minimum-weight edge in the cut defined by removing that edge from the tree. What is the order of growth of the running time of your method?

EXPERIMENTS

4.3.34 *Random sparse edge-weighted graphs.* Write a random-sparse-edge-weighted-graph generator based on your solution to EXERCISE 4.1.41. To assign edge weights, define a random-edge-weighted digraph ADT and write two implementations: one that generates uniformly distributed weights, another that generates weights according to a Gaussian distribution. Write client programs to generate sparse random edge-weighted graphs for both weight distributions with a well-chosen set of values of V and E so that you can use them to run empirical tests on graphs drawn from various distributions of edge weights.

4.3.35 *Random Euclidean edge-weighted graphs.* Modify your solution to EXERCISE 4.1.42 to assign the distance between vertices as each edge's weight.

4.3.36 *Random grid edge-weighted graphs.* Modify your your solution to EXERCISE 4.1.43 to assign a random weight (between 0 and 1) to each edge.

4.3.37 *Real edge-weighted graphs.* Find a large weighted graph somewhere online—perhaps a map with distances, telephone connections with costs, or an airline rate schedule. Write a program `RandomRealEdgeWeightedGraph` that builds a weighted graph by choosing V vertices at random and E weighted edges at random from the subgraph induced by those vertices.

Testing all algorithms and studying all parameters against all graph models is unrealistic. For each problem listed below, write a client that addresses the problem for any given input graph, then choose among the generators above to run experiments for that graph model. Use your judgment in selecting experiments, perhaps in response to results of previous experiments. Write a narrative explaining your results and any conclusions that might be drawn.

4.3.38 *Cost of laziness.* Run empirical studies to compare the performance of the lazy version of Prim's algorithm with the eager version, for various types of graphs.

4.3.39 *Prim versus Kruskal.* Run empirical studies to compare the performance of the lazy and eager versions of Prim's algorithm with Kruskal's algorithm.

4.3.40 *Reduced overhead.* Run empirical studies to determine the effect of using primitive types instead of `Edge` values in `EdgeWeightedGraph`, as described in EXERCISE 4.3.28.

EXPERIMENTS *(continued)*

4.3.41 *Longest MST edge.* Run empirical studies to analyze the length of the longest edge in the MST and the number of graph edges that are not longer than that one.

4.3.42 *Partitioning.* Develop an implementation based on integrating Kruskal's algorithm with quicksort partitioning (instead of using a priority queue) so as to check MST membership of each edge as soon as all smaller edges have been checked.

4.3.43 *Boruvka's algorithm.* Develop an implementation of Boruvka's algorithm: Build an MST by adding edges to a growing forest of trees, as in Kruskal's algorithm, but in stages. At each stage, find the minimum-weight edge that connects each tree to a different one, then add all such edges to the MST. Assume that the edge weights are all different, to avoid cycles. *Hint:* Maintain in a vertex-indexed array to identify the edge that connects each component to its nearest neighbor, and use the union-find data structure.

4.3.44 *Improved Boruvka.* Develop an implementation of Boruvka's algorithm that uses doubly-linked circular lists to represent MST subtrees so that subtrees can be merged and renamed in time proportional to E during each stage (and the union-find ADT is therefore not needed).

4.3.45 *External MST.* Describe how you would find the MST of a graph so large that only V edges can fit into main memory at once.

4.3.46 *Johnson's algorithm.* Develop a priority-queue implementation that uses a d -way heap (see EXERCISE 2.4.41). Find the best value of d for various weighted graph models.

This page intentionally left blank

4.4 SHORTEST PATHS

PERHAPS THE MOST INTUITIVE graph-processing problem is one that you encounter regularly, when using a map application or a navigation system to get directions from one place to another. A graph model is immediate: vertices correspond to intersections and edges correspond to roads, with weights on the edges that model the cost, perhaps distance or travel time. The possibility of one-way roads means that we will need to consider edge-weighted *digraphs*. In this model, the problem is easy to formulate:

Find the lowest-cost way to get from one vertex to another.

Beyond direct applications of this sort, the shortest-paths model is appropriate for a range of other problems, some of which do not seem to be at all related to graph processing. As one example, we shall consider the *arbitrage* problem from computational finance at the end of this section.

We adopt a general model where we work with *edge-weighted digraphs* (combining the models of SECTION 4.2 and SECTION 4.3). In SECTION 4.2 we wished to know whether it is *possible* to get from one vertex to another; in this section, we take weights into consideration, as we did for undirected edge-weighted graphs in SECTION 4.3. Every directed path in

application	vertex	edge
<i>map</i>	intersection	road
<i>network</i>	router	connection
<i>schedule</i>	job	precedence constraint
<i>arbitrage</i>	currency	exchange rate

Typical shortest-paths applications

an edge-weighted digraph has an associated *path weight*, the value of which is the sum of the weights of that path's edges. This essential measure allows us to formulate such problems as “find the lowest-weight directed path from one vertex to another,” the topic of this section. The figure at left shows an example.

edge-weighted digraph

4->5	0.35
5->4	0.35
4->7	0.37
5->7	0.28
7->5	0.28
5->1	0.32
0->4	0.38
0->2	0.26
7->3	0.39
1->3	0.29
2->7	0.34
6->2	0.40
3->6	0.52
6->0	0.58
6->4	0.93

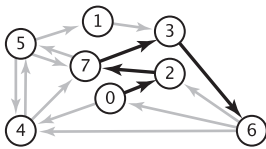

shortest path from 0 to 6

0->2	0.26
2->7	0.34
7->3	0.39
3->6	0.52

Definition. A *shortest path* from vertex s to vertex t in an edge-weighted digraph is a directed path from s to t with the property that no other such path has a lower weight.

An edge-weighted digraph and a shortest path

Thus, in this section, we consider classic algorithms for the following problem:

Single-source shortest paths. Given an edge-weighted digraph and a source vertex s , support queries of the form *Is there a directed path from s to a given target vertex t ?* If so, find a *shortest* such path (one whose total weight is minimal).

The plan of the section is to cover the following list of topics:

- Our APIs and implementations for edge-weighted digraphs, and a single-source shortest-paths API
- The classic Dijkstra's algorithm for the problem when weights are nonnegative
- A faster algorithm for acyclic edge-weighted digraphs (edge-weighted DAGs) that works even when edge weights can be negative
- The classic Bellman-Ford algorithm for use in the general case, when cycles may be present, edge weights may be negative, and we need algorithms for finding negative-weight cycles and shortest paths in edge-weighted digraphs with no such cycles

In the context of the algorithms, we also consider applications.

Properties of shortest paths The basic definition of the shortest-paths problem is succinct, but its brevity masks several points worth examining before we begin to formulate algorithms and data structures for solving it:

- *Paths are directed.* A shortest path must respect the direction of its edges.
- *The weights are not necessarily distances.* Geometric intuition can be helpful in understanding algorithms, so we use examples where vertices are points in the plane and weights are Euclidean distances, such as the digraph on the facing page. But the weights might represent time or cost or an entirely different variable and do not need to be proportional to a distance at all. We are emphasizing this point by using mixed-metaphor terminology where we refer to a *shortest* path of minimal *weight* or *cost*.
- *Not all vertices need be reachable.* If t is not reachable from s , there is no path at all, and therefore there is no shortest path from s to t . For simplicity, our small running example is strongly connected (every vertex is reachable from every other vertex).
- *Negative weights introduce complications.* For the moment, we assume that edge weights are positive (or zero). The surprising impact of negative weights is a major focus of the last part of this section.
- *Shortest paths are normally simple.* Our algorithms ignore zero-weight edges that form cycles, so that the shortest paths they find have no cycles.
- *Shortest paths are not necessarily unique.* There may be multiple paths of the low-

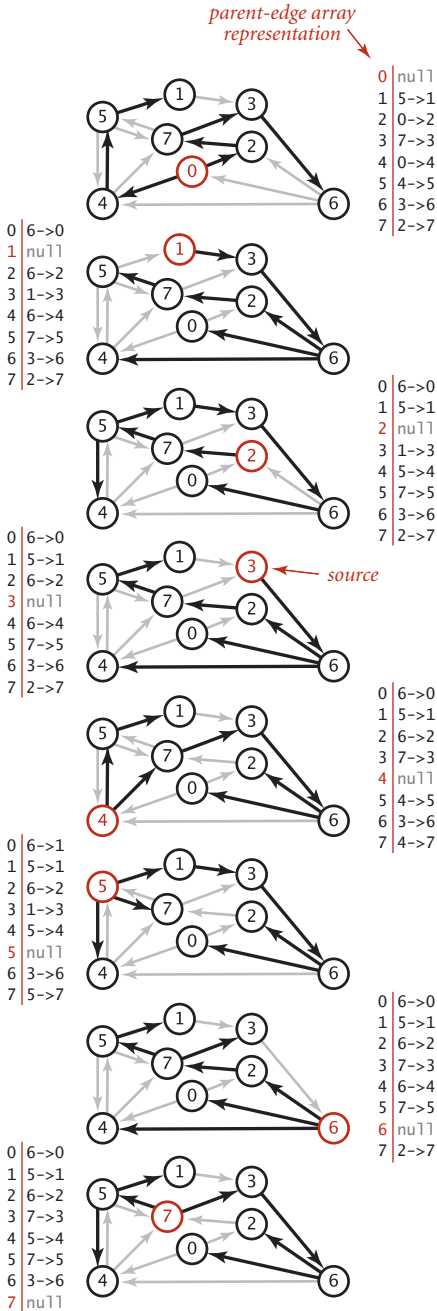

Shortest-paths trees

est weight from one vertex to another; we are content to find any one of them.

- *Parallel edges and self-loops may be present.* Only the lowest-weight among a set of parallel edges will play a role, and no shortest path contains a self-loop (except possibly one of zero weight, which we ignore). In the text, we implicitly assume that parallel edges are not present for convenience in using the notation $v \rightarrow w$ to refer unambiguously to the edge from v to w , but our code handles them without difficulty.

Shortest-paths tree We focus on the *single-source shortest-paths problem*, where we are given a source vertex s . The result of the computation is a tree known as the *shortest-paths tree* (SPT), which gives a shortest path from s to every vertex reachable from s .

Definition. Given an edge-weighted digraph and a designated vertex s , a *shortest-paths tree* for a source s is a subgraph containing s and all the vertices reachable from s that forms a directed tree rooted at s such that every tree path is a shortest path in the digraph.

Such a tree always exists: in general there may be two paths of the same length connecting s to a vertex; if that is the case, we can delete the final edge on one of them, continuing until we have only one path connecting the source to each vertex (a rooted tree). By building a shortest-paths tree, we can provide clients with the shortest path from s to any vertex in the graph, using a parent-link representation, in precisely the same manner as for paths in graphs in SECTION 4.1.

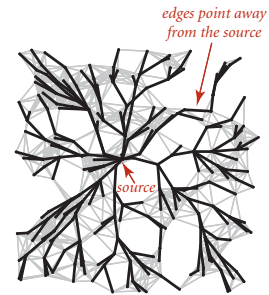

An SPT with 250 vertices

Edge-weighted digraph data types Our data type for directed edges is simpler than for undirected edges because we follow directed edges in just one direction. Instead of the `either()` and `other()` methods in `Edge`, we have `from()` and `to()` methods:

```
public class DirectedEdge
    DirectedEdge(int v, int w, double weight)
    double weight()           weight of this edge
    int from()                vertex this edge points from
    int to()                  vertex this edge points to
    String toString()         string representation
```

Weighted directed-edge API

As with our transition from `Graph` to `EdgeWeightedGraph` from SECTION 4.1 to SECTION 4.3, we include an `edges()` method and use `DirectedEdge` instead of integers:

```
public class EdgeWeightedDigraph
    EdgeWeightedDigraph(int V) empty V-vertex digraph
    EdgeWeightedDigraph(In in) construct from in
    int V()                     number of vertices
    int E()                     number of edges
    void addEdge(DirectedEdge e) add e to this digraph
    Iterable<DirectedEdge> adj(int v) edges pointing from v
    Iterable<DirectedEdge> edges() all edges in this digraph
    String toString()           string representation
```

Edge-weighted digraph API

You can find implementations of these two APIs on the following two pages. These are natural extensions of the implementations of SECTION 4.2 and SECTION 4.3. Instead of the adjacency lists of integers used in `Digraph`, we have adjacency lists of `DirectedEdge` objects in `EdgeWeightedDigraph`. As with the transition from `Graph` to `Digraph` from SECTION 4.1 to SECTION 4.2, the transition from `EdgeWeightedGraph` in SECTION 4.3 to `EdgeWeightedDigraph` in this section simplifies the code, since each edge appears only once in the data structure.

Directed weighted edge data type

```
public class DirectedEdge
{
    private final int v;           // edge source
    private final int w;           // edge target
    private final double weight;  // edge weight

    public DirectedEdge(int v, int w, double weight)
    {
        this.v = v;
        this.w = w;
        this.weight = weight;
    }

    public double weight()
    { return weight; }

    public int from()
    { return v; }

    public int to()
    { return w; }

    public String toString()
    { return String.format("%d->%d %.2f", v, w, weight); }
}
}
```

This `DirectedEdge` implementation is simpler than the undirected weighted `Edge` implementation of SECTION 4.3 (see page 610) because the two vertices are distinguished. Our clients use the idiomatic code `int v = e.to()`, `w = e.from()`; to access a `DirectedEdge` `e`'s two vertices.

Edge-weighted digraph data type

```

public class EdgeWeightedDigraph
{
    private final int V;           // number of vertices
    private int E;                 // number of edges
    private Bag<DirectedEdge>[] adj; // adjacency lists

    public EdgeWeightedDigraph(int V)
    {
        this.V = V;
        this.E = 0;
        adj = (Bag<DirectedEdge>[]) new Bag[V];
        for (int v = 0; v < V; v++)
            adj[v] = new Bag<DirectedEdge>();
    }

    public EdgeWeightedDigraph(In in)
    // See Exercise 4.4.2.

    public int V() { return V; }
    public int E() { return E; }

    public void addEdge(DirectedEdge e)
    {
        adj[e.from()].add(e);
        E++;
    }

    public Iterable<Edge> adj(int v)
    { return adj[v]; }

    public Iterable<DirectedEdge> edges()
    {
        Bag<DirectedEdge> bag = new Bag<DirectedEdge>();
        for (int v = 0; v < V; v++)
            for (DirectedEdge e : adj[v])
                bag.add(e);
        return bag;
    }
}

```

This `EdgeWeightedDigraph` implementation is an amalgam of `EdgeWeightedGraph` and `Digraph` that maintains a vertex-indexed array of bags of `DirectedEdge` objects. As with `Digraph`, every edge appears just once: if an edge connects v to w , it appears in v 's adjacency list. Self-loops and parallel edges are allowed. The `toString()` implementation is left as **EXERCISE 4.4.2**.

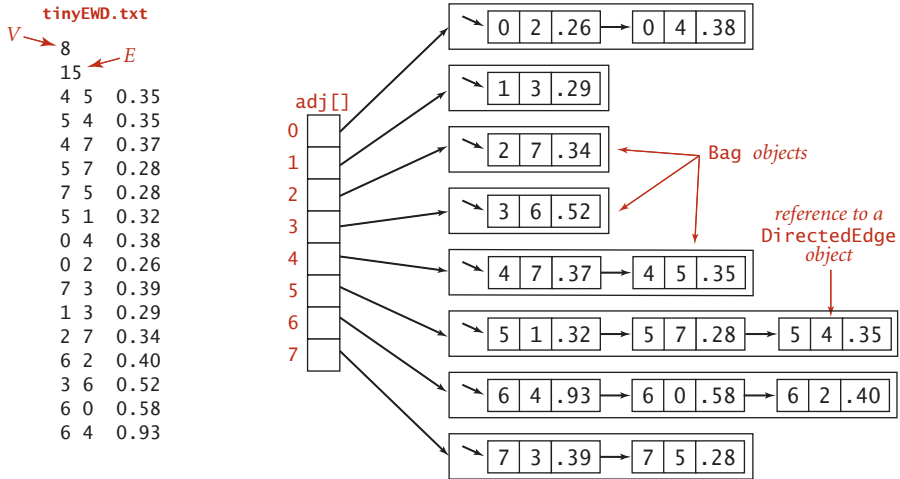

Edge-weighted digraph representation

The figure above shows the data structure that `EdgeWeightedDigraph` builds to represent the digraph defined by the edges at left when they are added in the order they appear. As usual, we use `Bag` to represent adjacency lists and depict them as linked lists, the standard representation. As with the unweighted digraphs of SECTION 4.2, only one representation of each edge appears in the data structure.

Shortest-paths API. For shortest paths, we use the same design paradigm as for the `DepthFirstPaths` and `BreadthFirstPaths` APIs in SECTION 4.1. Our algorithms implement the following API to provide clients with shortest paths and their lengths:

```

public class SP
    SP(EdgeWeightedDigraph G, int s)  constructor
        double distTo(int v)          distance from s
                                        to v, ∞ if no path
        boolean hasPathTo(int v)      path from s to v?
        Iterable<DirectedEdge> pathTo(int v) path from s to v,
                                                null if none

```

API for shortest-paths implementations

The constructor builds the shortest-paths tree and computes shortest-paths distances; the client query methods use those data structures to provide distances and iterable paths to the client.

Test client. A sample client is shown below. It takes an input stream and source vertex index as command-line arguments, reads the edge-weighted digraph from the input stream, computes the SPT of that digraph for the source, and prints the shortest path from the source to each of the other vertices. We assume that all of our shortest-paths implementations include this test client. Our examples use the file `tinyEWD.txt` shown on the facing page, which defines the edges and weights that are used in the small sample digraph that we use for detailed traces of shortest-paths algorithms. It uses the same file format that we used for MST algorithms: the number of vertices V and the number of edges E followed by E lines, each with two vertex indices and a weight. You can also find on the booksite files that define several larger edge-weighted digraphs, including the file `mediumEWD.txt` which defines the 250-vertex graph drawn on page 640. In the drawing of the graph, every line represents edges in both directions, so this file has twice as many lines as the corresponding file `mediumEWG.txt` that we examined for MSTs. In the drawing of the SPT, each line represents a directed edge pointing away from the source.

```
public static void main(String[] args)
{
    EdgeWeightedDigraph G;
    G = new EdgeWeightedDigraph(new In(args[0]));
    int s = Integer.parseInt(args[1]);
    SP sp = new SP(G, s);

    for (int t = 0; t < G.V(); t++)
    {
        StdOut.print(s + " to " + t);
        StdOut.printf(" (%.2f): ", sp.distTo(t));
        if (sp.hasPathTo(t))
            for (DirectedEdge e : sp.pathTo(t))
                StdOut.print(e + " ");
        StdOut.println();
    }
}
```

Shortest paths test client

```
% java SP tinyEWD.txt 0
0 to 0 (0.00):
0 to 1 (1.05): 0->4 0.38 4->5 0.35 5->1 0.32
0 to 2 (0.26): 0->2 0.26
0 to 3 (0.99): 0->2 0.26 2->7 0.34 7->3 0.39
0 to 4 (0.38): 0->4 0.38
0 to 5 (0.73): 0->4 0.38 4->5 0.35
0 to 6 (1.51): 0->2 0.26 2->7 0.34 7->3 0.39 3->6 0.52
0 to 7 (0.60): 0->2 0.26 2->7 0.34
```

Data structures for shortest paths. The data structures that we need to represent shortest paths are straightforward:

- *Edges on the shortest-paths tree:* As for DFS, BFS, and Prim’s algorithm, we use a parent-edge representation in the form of a vertex-indexed array `edgeTo[]` of `DirectedEdge` objects, where `edgeTo[v]` is edge that connects `v` to its parent in the tree (the last edge on a shortest path from `s` to `v`).
- *Distance to the source:* We use a vertex-indexed array `distTo[]` such that `distTo[v]` is the length of the shortest known path from `s` to `v`.

By convention, `edgeTo[s]` is `null` and `distTo[s]` is 0. We also adopt the convention that distances to vertices that are not reachable from the source are all `Double.POSITIVE_INFINITY`. As usual, we will develop data types that build these data structures in the constructor and then support instance methods that use them to support client queries for shortest paths and shortest-path distances.

Edge relaxation. Our shortest-paths implementations are based on a simple operation known as *relaxation*. We start knowing only the graph’s edges and weights, with the `distTo[]` entry for the source initialized to 0 and all of the other `distTo[]` entries initialized to `Double.POSITIVE_INFINITY`. As an algorithm proceeds, it gathers information about the shortest paths that connect the source to each vertex encountered in our `edgeTo[]` and `distTo[]` data structures. By updating this information when we encounter edges, we can make new inferences about shortest paths. Specifically, we use *edge relaxation*, defined as follows: to *relax* an edge `v->w` means to test whether the best known way from `s` to `w` is to go from `s` to `v`, then take the edge from `v` to `w`, and, if so, update our data structures to indicate that to be the case. The code at the right implements this operation. The best known distance to `w` through `v` is the sum of `distTo[v]` and `e.weight()`—if that value is not smaller than `distTo[w]`, we say the edge is *ineligible*, and we ignore it; if it is smaller, we update the data

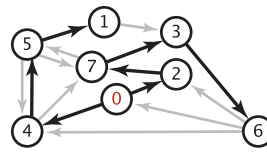

	edgeTo[]	distTo[]
0	null	0
1	5->1 0.32	1.05
2	0->2 0.26	0.26
3	7->3 0.37	0.97
4	0->4 0.38	0.38
5	4->5 0.35	0.73
6	3->6 0.52	1.49
7	2->7 0.34	0.60

Shortest-paths data structures

is smaller, we update the data

```
private void relax(DirectedEdge e)
{
    int v = e.from(), w = e.to();
    if (distTo[w] > distTo[v] + e.weight())
    {
        distTo[w] = distTo[v] + e.weight();
        edgeTo[w] = e;
    }
}
```

Edge relaxation

structures. The figure at the bottom of this page illustrates the two possible outcomes of an edge-relaxation operation. Either the edge is ineligible (as in the example at left) and no changes are made, or the edge $v \rightarrow w$ leads to a shorter path to w (as in the example at right) and we update $\text{edgeTo}[w]$ and $\text{distTo}[w]$ (which might render some other edges ineligible and might create some new eligible edges). The term *relaxation* follows from the idea of a rubber band stretched tight on a path connecting two vertices: relaxing an edge is akin to relaxing the tension on the rubber band along a shorter path, if possible. We say that an edge e can be *successfully relaxed* if $\text{relax}()$ would change the values of $\text{distTo}[e.\text{to}()]$ and $\text{edgeTo}[e.\text{to}()]$.

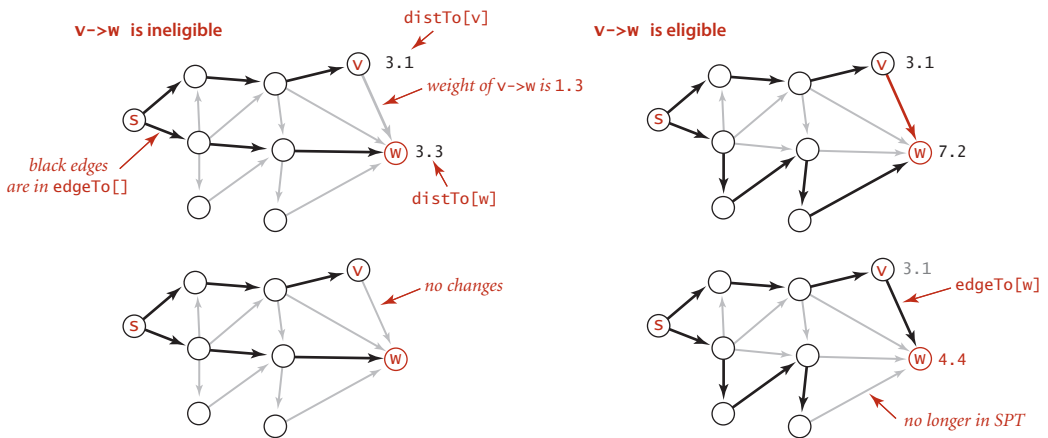

Edge relaxation (two cases)

Vertex relaxation. All of our implementations actually relax *all* the edges pointing from a given vertex as shown in the (overloaded) implementation of `relax()` below. Note that any edge from a vertex whose `distTo[v]` entry is finite to a vertex whose `distTo[]` entry is infinite is eligible and will be added to `edgeTo[]` if relaxed. In particular, some edge leaving the source is the first to be added to `edgeTo[]`. Our algorithms choose vertices judiciously, so that each vertex relaxation finds a shorter path than the best known so far to some vertex, incrementally progressing toward the goal of finding shortest paths to every vertex.

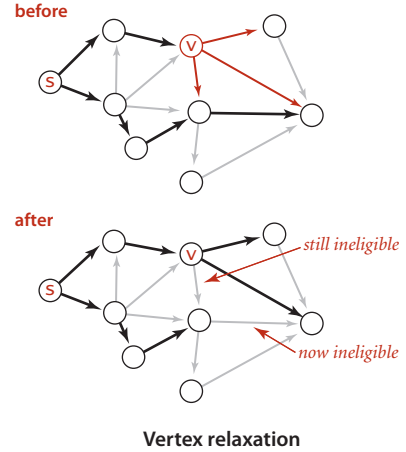

```
private void relax(EdgeWeightedDigraph G, int v)
{
    for (DirectedEdge e : G.adj(v))
    {
        int w = e.to();
        if (distTo[w] > distTo[v] + e.weight())
        {
            distTo[w] = distTo[v] + e.weight();
            edgeTo[w] = e;
        }
    }
}
```

Vertex relaxation

Client query methods. In a manner similar to our implementations for pathfinding APIs in SECTION 4.1 (and EXERCISE 4.1.13), the `edgeTo[]` and `distTo[]` data structures directly support the `pathTo()`, `hasPathTo()`, and `distTo()` client query methods, as shown below. This code is included in all of our shortest-paths implementations. As we have noted already, `distTo[v]` is only meaningful when `v` is reachable from `s` and we adopt the convention that `distTo()` should return infinity for vertices that are not reachable from `s`. To implement this convention, we initialize all `distTo[]` entries to `Double.POSITIVE_INFINITY` and `distTo[s]` to 0; then our shortest-paths implementations will set `distTo[v]` to a finite value for all vertices `v` that are reachable from the source. Thus, we can dispense with the `marked[]` array that we normally use to mark reachable vertices in a graph search and implement `hasPathTo(v)` by testing whether `distTo[v]` equals `Double.POSITIVE_INFINITY`. For `pathTo()`, we use the convention that `pathTo(v)` returns `null` if `v` is not reachable from the source and a path with no edges if `v` is the source. For reachable vertices, we travel up the tree, pushing the edges that we find on a stack, in the same manner as we did for `DepthFirstPaths` and `BreadthFirstPaths`. The figure at right shows the discovery of the path `0->2->7->3->6` for our example.

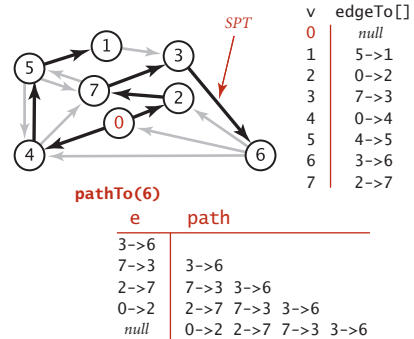
Trace of `pathTo()` computation

```

public double distTo(int v)
{ return distTo[v]; }

public boolean hasPathTo(int v)
{ return distTo[v] < Double.POSITIVE_INFINITY; }

public Iterable<DirectedEdge> pathTo(int v)
{
    if (!hasPathTo(v)) return null;
    Stack<DirectedEdge> path = new Stack<DirectedEdge>();
    for (DirectedEdge e = edgeTo[v]; e != null; e = edgeTo[e.from()])
        path.push(e);
    return path;
}

```

Client query methods for shortest paths

Theoretical basis for shortest-paths algorithms. Edge relaxation is an easy-to-implement fundamental operation that provides a practical basis for our shortest-paths implementations. It also provides a theoretical basis for understanding the algorithms and an opportunity for us to do our algorithm correctness proofs at the outset.

Optimality conditions. The following proposition shows an equivalence between the *global* condition that the distances are shortest-paths distances, and the *local* condition that we test to relax an edge.

Proposition P. (Shortest-paths optimality conditions) Let G be an edge-weighted digraph, with s a source vertex in G and $\text{distTo}[]$ a vertex-indexed array of path lengths in G such that, for all v reachable from s , the value of $\text{distTo}[v]$ is the length of *some* path from s to v with $\text{distTo}[v]$ equal to infinity for all v not reachable from s . These values are the lengths of *shortest* paths if and only if they satisfy $\text{distTo}[w] \leq \text{distTo}[v] + e.\text{weight}()$ for each edge e from v to w (or, in other words, no edge is eligible).

Proof: Suppose that $\text{distTo}[w]$ is the length of a shortest path from s to w . If $\text{distTo}[w] > \text{distTo}[v] + e.\text{weight}()$ for some edge e from v to w , then e would give a path from s to w (through v) of length less than $\text{distTo}[w]$, a contradiction. Thus the optimality conditions are necessary.

To prove that the optimality conditions are sufficient, suppose that w is reachable from s and that $s = v_0 \rightarrow v_1 \rightarrow v_2 \dots \rightarrow v_k = w$ is a shortest path from s to w , of weight OPT_{sw} . For i from 1 to k , denote the edge from v_{i-1} to v_i by e_i . By the optimality conditions, we have the following sequence of inequalities:

$$\begin{aligned} \text{distTo}[w] = \text{distTo}[v_k] &\leq \text{distTo}[v_{k-1}] + e_k.\text{weight}() \\ \text{distTo}[v_{k-1}] &\leq \text{distTo}[v_{k-2}] + e_{k-1}.\text{weight}() \\ &\dots \\ \text{distTo}[v_2] &\leq \text{distTo}[v_1] + e_2.\text{weight}() \\ \text{distTo}[v_1] &\leq \text{distTo}[s] + e_1.\text{weight}() \end{aligned}$$

Collapsing these inequalities and eliminating $\text{distTo}[s] = 0.0$, we have

$$\text{distTo}[w] \leq e_1.\text{weight}() + \dots + e_k.\text{weight}() = \text{OPT}_{sw}.$$

Now, $\text{distTo}[w]$ is the length of *some* path from s to w , so it cannot be smaller than the length of a *shortest* path. Thus, we have shown that

$$\text{OPT}_{sw} \leq \text{distTo}[w] \leq \text{OPT}_{sw}$$

and equality must hold.

Certification. An important practical consequence of PROPOSITION P is its applicability to certification. However an algorithm computes $\text{distTo}[]$, we can check whether it contains shortest-path lengths in a single pass through the edges of the graph, checking whether the optimality conditions are satisfied. Shortest-paths algorithms can be complicated, and this ability to efficiently test their outcome is crucial. We include a method `check()` in our implementations on the booksite for this purpose. This method also checks that $\text{edgeTo}[]$ specifies paths from the source and is consistent with $\text{distTo}[]$.

Generic algorithm. The optimality conditions lead immediately to a generic algorithm that encompasses all of the shortest-paths algorithms that we consider. For the moment, we restrict attention to nonnegative weights.

Proposition Q. (Generic shortest-paths algorithm) Initialize $\text{distTo}[s]$ to 0 and all other $\text{distTo}[]$ values to infinity, and proceed as follows:

Relax any edge in G , continuing until no edge is eligible.

For all vertices w reachable from s , the value of $\text{distTo}[w]$ after this computation is the length of a shortest path from s to w (and the value of $\text{edgeTo}[]$ is the last edge on that path).

Proof: Relaxing an edge $v \rightarrow w$ always sets $\text{distTo}[w]$ to the length of some path from s (and $\text{edgeTo}[w]$ to the last edge on that path). For any vertex w reachable from s , some edge on the shortest path to w is eligible as long as $\text{distTo}[w]$ remains infinite, so the algorithm continues until the $\text{distTo}[]$ value of each vertex reachable from s is the length of some path to that vertex. For any vertex v for which the shortest path is well-defined, throughout the algorithm $\text{distTo}[v]$ is the length of some (simple) path from s to v and is strictly monotonically decreasing. Thus, it can decrease at most a finite number of times (once for each simple path from s to v). When no edge is eligible, PROPOSITION P applies.

The key reason for considering the optimality conditions and the generic algorithm is that the generic algorithm *does not specify in which order the edges are to be relaxed*. Thus, all that we need to do to prove that any algorithm computes shortest paths is to prove that it relaxes edges until no edge is eligible.

Dijkstra's algorithm In SECTION 4.3, we discussed Prim's algorithm for finding the minimum spanning tree (MST) of an edge-weighted undirected graph: we build the MST by attaching a new edge to a single growing tree at each step. *Dijkstra's algorithm* is an analogous scheme to compute an SPT. We begin by initializing $\text{dist}[s]$ to 0 and all other $\text{distTo}[]$ entries to positive infinity, then we *relax and add to the tree a non-tree vertex with the lowest $\text{distTo}[]$ value, continuing until all vertices are on the tree or no non-tree vertex has a finite $\text{distTo}[]$ value.*

Proposition R. Dijkstra's algorithm solves the single-source shortest-paths problem in edge-weighted digraphs with nonnegative weights.

Proof: If v is reachable from the source, every edge $v \rightarrow w$ is relaxed exactly once, when v is relaxed, leaving $\text{distTo}[w] \leq \text{distTo}[v] + e.\text{weight}()$. This inequality holds until the algorithm completes, since $\text{distTo}[w]$ can only decrease (any relaxation can only decrease a $\text{distTo}[]$ value) and $\text{distTo}[v]$ never changes (because edge weights are nonnegative and we choose the lowest $\text{distTo}[]$ value at each step, no subsequent relaxation can set any $\text{distTo}[]$ entry to a lower value than $\text{distTo}[v]$). Thus, after all vertices reachable from s have been added to the tree, the shortest-paths optimality conditions hold, and PROPOSITION P applies.

Data structures. To implement Dijkstra's algorithm we add to our $\text{distTo}[]$ and $\text{edgeTo}[]$ data structures an index priority queue pq to keep track of vertices that are candidates for being the next to be relaxed. Recall that an `IndexMinPQ` allows us to associate indices with keys (priorities) and to remove and return the index corresponding to the lowest key. For this application, we always associate a vertex v with $\text{distTo}[v]$, and we have a direct and immediate implementation of Dijkstra's algorithm as stated. Moreover, it is immediate by induction that the $\text{edgeTo}[]$ entries corresponding to reachable vertices form a tree, the SPT.

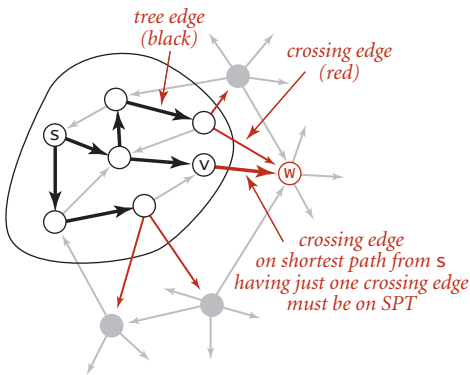

Dijkstra's shortest-paths algorithm

Alternative viewpoint. Another way to understand the dynamics of the algorithm derives from the proof, diagrammed at left: we have the invariant that $\text{distTo}[]$ entries for tree vertices are shortest-paths distances and for each vertex w on the priority queue, $\text{distTo}[w]$ is the weight of a shortest path from s to w that uses only

intermediate vertices in the tree and ends in the crossing edge $edgeTo[w]$. The $distTo[]$ entry for the vertex with the *smallest* priority is a shortest-path weight, not smaller than the shortest-path weight to any vertex already relaxed, and not larger than the shortest-path weight to any vertex not yet relaxed. That vertex is next to be relaxed. Reachable vertices are relaxed in order of the weight of their shortest path from s .

The figure at right is a trace for our small sample graph `tinyEWD.txt`. For this example, the algorithm builds the SPT as follows:

- Adds 0 to the tree and its adjacent vertices 2 and 4 to the priority queue.
- Removes 2 from the priority queue, adds 0→2 to the tree, and adds 7 to the priority queue.
- Removes 4 from the priority queue, adds 0→4 to the tree, and adds 5 to the priority queue. Edge 4→7 is ineligible.
- Removes 7 from the priority queue, adds 2→7 to the tree, and adds 3 to the priority queue. Edge 7→5 is ineligible.
- Removes 5 from the priority queue, adds 4→5 to the tree, and adds 1 to the priority queue. Edge 5→7 is ineligible.
- Removes 3 from the priority queue, adds 7→3 to the tree, and adds 6 to the priority queue.
- Removes 1 from the priority queue and adds 5→1 to the tree. Edge 1→3 is ineligible.
- Removes 6 from the priority queue and adds 3→6 to the tree.

Vertices are added to the SPT in increasing order of their distance from the source, as indicated by the red arrows at the right edge of the diagram.

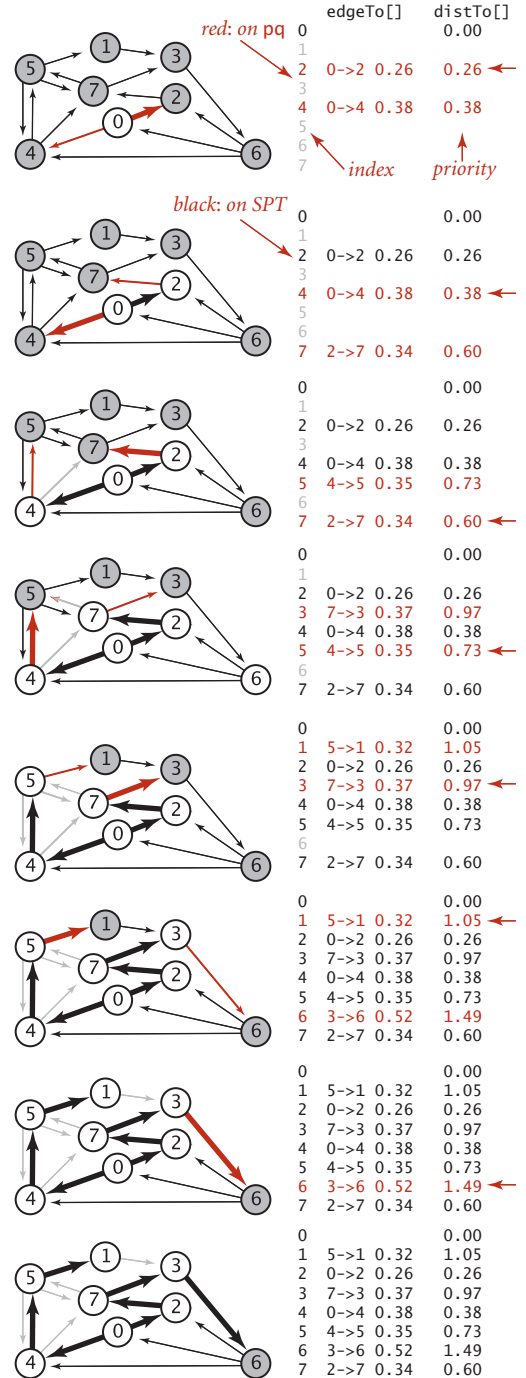

Trace of Dijkstra's algorithm

The implementation of Dijkstra’s algorithm in `DijkstraSP` (ALGORITHM 4.9) is a rendition in code of the one-sentence description of the algorithm, enabled by adding one statement to `relax()` to handle two cases: either the `to()` vertex on an edge is not yet on the priority queue, in which case we use `insert()` to add it to the priority queue, or it is already on the priority queue and its priority lowered, in which case `change()` does so.

Proposition R (continued). Dijkstra’s algorithm uses extra space proportional to V and time proportional to $E \log V$ (in the worst case) to compute the SPT rooted at a given source in an edge-weighted digraph with E edges and V vertices.

Proof: Same as for Prim’s algorithm (see PROPOSITION N).

AS WE HAVE INDICATED, ANOTHER WAY TO THINK ABOUT Dijkstra’s algorithm is to compare it to Prim’s MST algorithm from SECTION 4.3 (see page 622). Both algorithms build a rooted tree by adding an edge to a growing tree: Prim’s adds next the non-tree vertex that is closest to the *tree*; Dijkstra’s adds next the non-tree vertex that is closest to the *source*. The `marked[]` array is not needed, because the condition `!marked[w]` is equivalent to the condition that `distTo[w]` is infinite. In other words, switching to undirected graphs and edges and omitting the references to `distTo[v]` in the `relax()` code in ALGORITHM 4.9 gives an implementation of ALGORITHM 4.7, the eager version of Prim’s algorithm (!). Also, a lazy version of Dijkstra’s algorithm along the lines of `LazyPrimMST` (page 619) is not difficult to develop.

Variants. Our implementation of Dijkstra’s algorithm, with suitable modifications, is effective for solving other versions of the problem, such as the following:

Single-source shortest paths in undirected graphs. Given an edge-weighted *undirected* graph and a source vertex s , support queries of the form *Is there a path from s to a given target vertex v ? If so, find a shortest such path (one whose total weight is minimal).*

The solution to this problem is immediate if we view the undirected graph as a digraph. That is, given an undirected graph, build an edge-weighted digraph with the same vertices and with two directed edges (one in each direction) corresponding to each edge in the graph. There is a one-to-one correspondence between paths in the digraph and paths in the graph, and the costs of the paths are the same—the shortest-paths problems are equivalent.

ALGORITHM 4.9 Dijkstra's shortest-paths algorithm

```

public class DijkstraSP
{
    private DirectedEdge[] edgeTo;
    private double[] distTo;
    private IndexMinPQ<Double> pq;

    public DijkstraSP(EdgeWeightedDigraph G, int s)
    {
        edgeTo = new DirectedEdge[G.V()];
        distTo = new double[G.V()];
        pq = new IndexMinPQ<Double>(G.V());

        for (int v = 0; v < G.V(); v++)
            distTo[v] = Double.POSITIVE_INFINITY;
        distTo[s] = 0.0;

        pq.insert(s, 0.0);
        while (!pq.isEmpty())
            relax(G, pq.delMin())
    }

    private void relax(EdgeWeightedDigraph G, int v)
    {
        for(DirectedEdge e : G.adj(v))
        {
            int w = e.to();
            if (distTo[w] > distTo[v] + e.weight())
            {
                distTo[w] = distTo[v] + e.weight();
                edgeTo[w] = e;
                if (pq.contains(w)) pq.change(w, distTo[w]);
                else                pq.insert(w, distTo[w]);
            }
        }
    }

    public double distTo(int v)           // standard client query methods
    public boolean hasPathTo(int v)      //   for SPT implementatations
    public Iterable<Edge> pathTo(int v)  //   (See page 649.)
}

```

This implementation of Dijkstra's algorithm grows the SPT by adding an edge at a time, always choosing the edge from a tree vertex to a non-tree vertex whose destination w is closest to s .

Source-sink shortest paths. Given an edge-weighted digraph, a source vertex s , and a target vertex t , find the shortest path from s to t .

To solve this problem, use Dijkstra’s algorithm, but terminate the search as soon as t comes off the priority queue.

All-pairs shortest paths. Given an edge-weighted digraph, support queries of the form *Given a source vertex s and a target vertex t , is there a path from s to t ?* If so, find a *shortest* such path (one whose total weight is minimal).

The surprisingly compact implementation at right below solves the all-pairs shortest paths problem, using time and space proportional to $EV \log V$. It builds an array of `DijkstraSP` objects, one for each vertex as the source. To answer a client query, it uses the source to access the corresponding single-source shortest-paths object and then passes the target as argument to the query.

Shortest paths in Euclidean graphs. Solve the single-source, source-sink, and all-pairs shortest-paths problems in graphs where vertices are points in the plane and edge weights are proportional to Euclidean distances between vertices.

A simple modification considerably speeds up Dijkstra’s algorithm in this case (see EXERCISE 4.4.27).

THE FIGURES ON THE FACING PAGE show the emergence of the SPT as computed by Dijkstra’s algorithm for the Euclidean graph defined by our test file `mediumEWD.txt` (see

page 645) for several different sources. Recall that line segments in this graph represent directed edges in both directions. Again, these figures illustrate a fascinating dynamic process.

Next, we consider shortest-paths algorithms for acyclic edge-weighted graphs, where we can solve the problem in linear time (faster than Dijkstra’s algorithm) and then for edge-weighted digraphs with negative weights, where Dijkstra’s algorithm does not apply.

```
public class DijkstraAllPairsSP
{
    private DijkstraSP[] all;

    DijkstraAllPairsSP(EdgeWeightedDigraph G)
    {
        all = new DijkstraSP[G.VC()]
        for (int v = 0; v < G.VC(); v++)
            all[v] = new DijkstraSP(G, v);
    }

    Iterable<Edge> path(int s, int t)
    { return all[s].pathTo(t); }

    double dist(int s, int t)
    { return all[s].distTo(t); }
}
```

All-pairs shortest paths

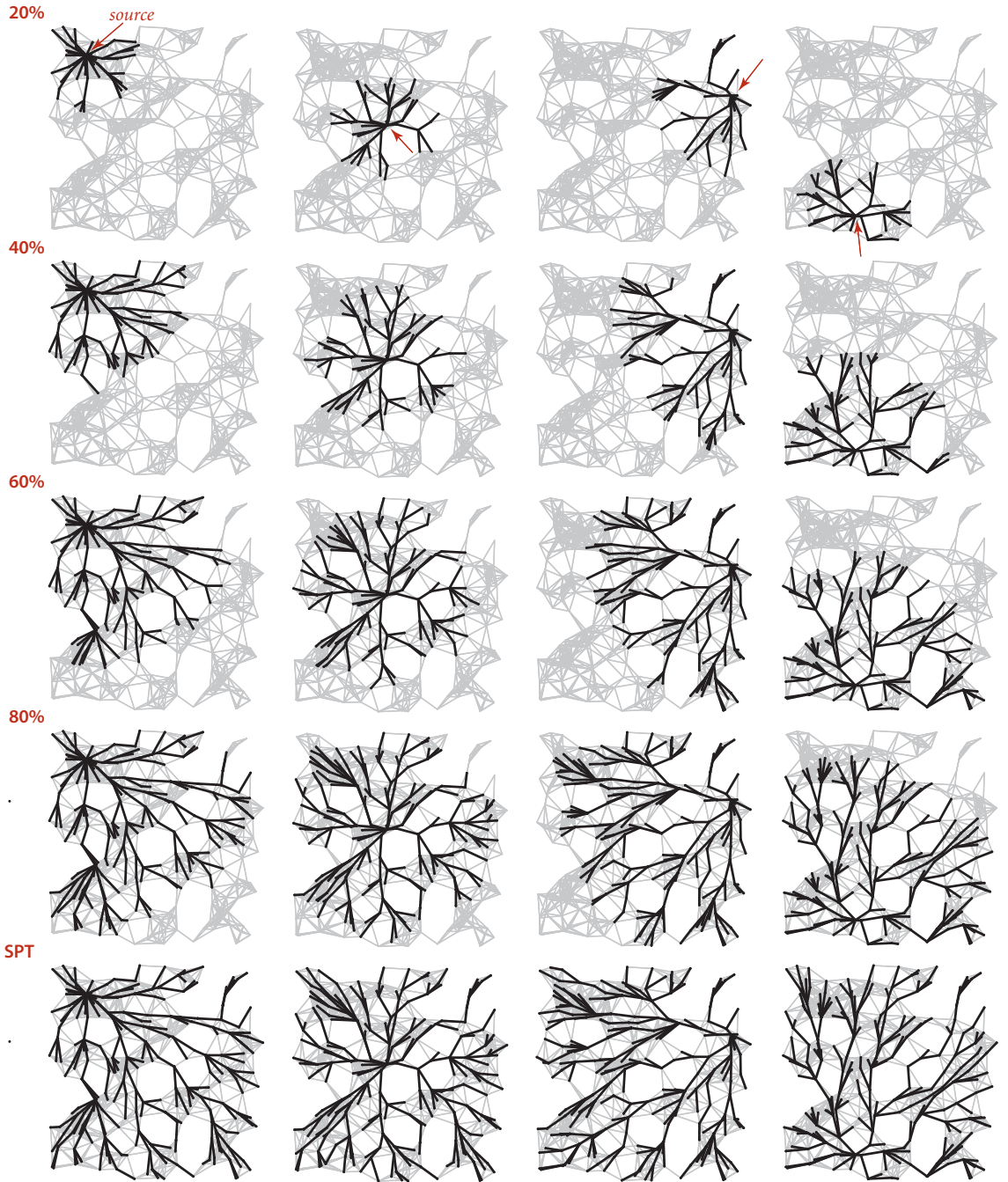

Dijkstra's algorithm (250 vertices, various sources)

Acyclic edge-weighted digraphs For many natural applications, edge-weighted digraphs are known to have no directed cycles. For economy, we use the equivalent term *edge-weighted DAG* to refer to an acyclic edge-weighted digraph. We now consider an algorithm for finding shortest paths that is simpler and faster than Dijkstra's algorithm for edge-weighted DAGs. Specifically, it

- Solves the single-source problem in linear time
- Handles negative edge weights
- Solves related problems, such as finding *longest* paths.

These algorithms are straightforward extensions to the algorithm for topological sort in DAGs that we considered in SECTION 4.2.

Specifically, vertex relaxation, in combination with topological sorting, immediately presents a solution to the single-source shortest-paths problem for edge-weighted DAGs. We initialize `distTo[s]` to 0 and all other `distTo[]` values to infinity, then relax the vertices, one by one, *taking the vertices in topological order*. An argument similar to (but simpler than) the argument that we used for Dijkstra's algorithm on page 652 establishes the effectiveness of this method:

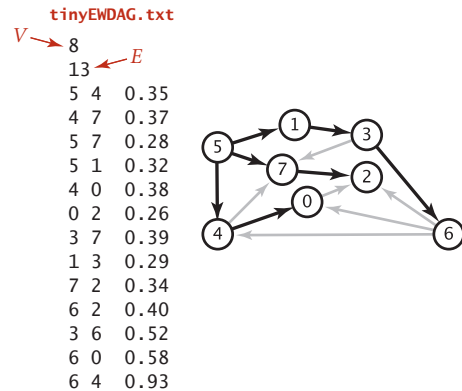

An acyclic edge-weighted digraph with an SPT

Proposition 5. By relaxing vertices in topological order, we can solve the single-source shortest-paths problem for edge-weighted DAGs in time proportional to $E + V$.

Proof: Every edge $v \rightarrow w$ is relaxed exactly once, when v is relaxed, leaving $\text{distTo}[w] \leq \text{distTo}[v] + e.\text{weight}()$. This inequality holds until the algorithm completes, since $\text{distTo}[v]$ never changes (because of the topological order, no edge pointing to v will be processed after v is relaxed) and $\text{distTo}[w]$ can only decrease (any relaxation can only decrease a $\text{distTo}[]$ value). Thus, after all vertices reachable from s have been added to the tree, the shortest-paths optimality conditions hold, and PROPOSITION Q applies. The time bound is immediate: PROPOSITION G on page 583 tells us that the topological sort takes time proportional to $E + V$, and the second relaxation pass completes the job by relaxing each edge once, again in time proportional to $E + V$.

The figure at right is a trace for a sample acyclic edge-weighted digraph `tinyEW DAG.txt`. For this example, the algorithm builds the shortest-paths tree from vertex 5 as follows:

- Does a DFS to discover the topological order
5 1 3 6 4 7 0 2.
- Adds to the tree 5 and all edges leaving it.
- Adds to the tree 1 and 1->3.
- Adds to the tree 3 and 3->6, but not 3->7, which is ineligible.
- Adds to the tree 6 and edges 6->2 and 6->0, but not 6->4, which is ineligible.
- Adds to the tree 4 and 4->0, but not 4->7, which is ineligible. Edge 6->0 becomes ineligible.
- Adds to the tree 7 and 7->2. Edge 6->2 becomes ineligible.
- Adds 0 to the tree, but not its incident edge 0->2, which is ineligible.
- Adds 2 to the tree.

The addition of 2 to the tree is not depicted; the last vertex in a topological sort has no edges leaving it.

The implementation, shown in ALGORITHM 4.10, is a straightforward application of code we have already considered. It assumes that `Topological` has overloaded methods for the topological sort, using the `EdgeWeightedDigraph` and `DirectedEdge` APIs of this section (see EXERCISE 4.4.12). Note that our boolean array `marked[]` is not needed in this implementation: since we are processing vertices in an acyclic digraph in topological order, we never re-encounter a vertex that we have already relaxed. ALGORITHM 4.10 could hardly be more efficient: after the topological sort, the constructor scans the graph, relaxing each edge exactly once. It is the method of choice for finding shortest paths in edge-weighted graphs that are known to be acyclic.

PROPOSITION 5 is significant because it provides a concrete example where the absence of cycles

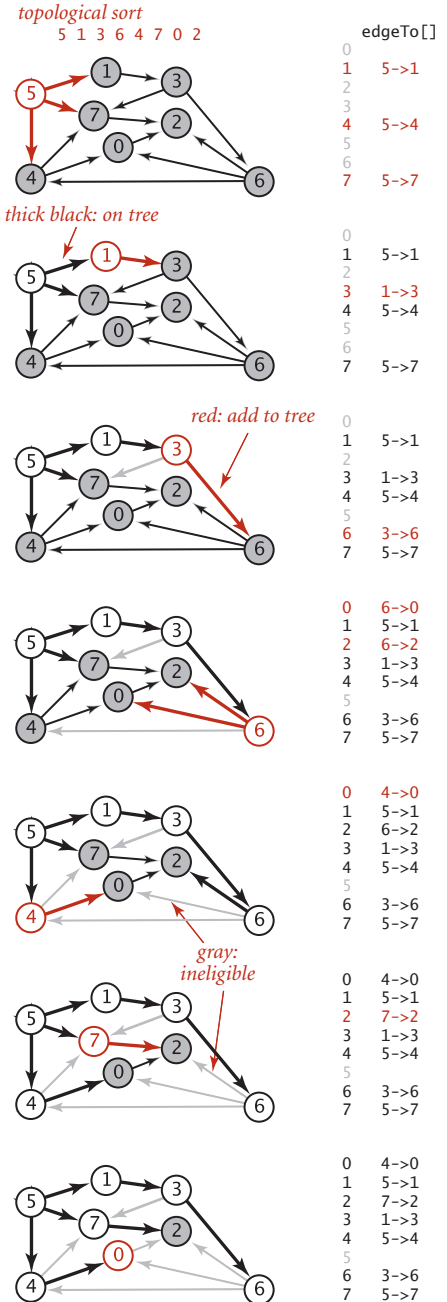

Trace for shortest paths in an edge-weighted DAG

ALGORITHM 4.10 Shortest paths in edge-weighted DAGs

```

public class AcyclicSP
{
    private DirectedEdge[] edgeTo;
    private double[] distTo;

    public AcyclicSP(EdgeWeightedDigraph G, int s)
    {
        edgeTo = new DirectedEdge[G.V()];
        distTo = new double[G.V()];

        for (int v = 0; v < G.V(); v++)
            distTo[v] = Double.POSITIVE_INFINITY;
        distTo[s] = 0.0;

        Topological top = new Topological(G);
        for (int v : top.order())
            relax(G, v);
    }

    private void relax(EdgeWeightedDigraph G, int v)
    // See page 648.

    public double distTo(int v)           // standard client query methods
    public boolean hasPathTo(int v)       // for SPT implementations
    public Iterable<Edge> pathTo(int v)   // (See page 649.)
}

```

This shortest-paths algorithm for edge-weighted DAGs uses a topological sort (ALGORITHM 4.5, adapted to use `EdgeWeightedDigraph` and `DirectedEdge`) to enable it to relax the vertices in topological order, which is all that is needed to compute shortest paths.

```

% java AcyclicSP tinyEWDAG.txt 5
5 to 0 (0.73): 5->4 0.35 4->0 0.38
5 to 1 (0.32): 5->1 0.32
5 to 2 (0.62): 5->7 0.28 7->2 0.34
5 to 3 (0.62): 5->1 0.32 1->3 0.29
5 to 4 (0.35): 5->4 0.35
5 to 5 (0.00):
5 to 6 (1.13): 5->1 0.32 1->3 0.29 3->6 0.52
5 to 7 (0.28): 5->7 0.28

```

considerably simplifies a problem. For shortest paths, the topological-sort-based method is faster than Dijkstra's algorithm by a factor proportional to the cost of the priority-queue operations in Dijkstra's algorithm. Moreover, the proof of PROPOSITION S does not depend on the edge weights being nonnegative, so we can remove that restriction for edge-weighted DAGs. Next, we consider implications of this ability to allow negative edge weights, by considering the use of the shortest-paths model to solve two other problems, one of which seems at first blush to be quite removed from graph processing.

Longest paths. Consider the problem of finding the *longest* path in an edge-weighted DAG with edge weights that may be positive or negative.

Single-source longest paths in edge-weighted DAGs. Given an edge-weighted DAG (with negative weights allowed) and a source vertex s , support queries of the form: *Is there a directed path from s to a given target vertex v ? If so, find a longest such path (one whose total weight is maximal).*

The algorithm just considered provides a quick solution to this problem:

Proposition T. We can solve the longest-paths problem in edge-weighted DAGs in time proportional to $E + V$.

Proof: Given a longest-paths problem, create a copy of the given edge-weighted DAG that is identical to the original, except that all edge weights are negated. Then the *shortest* path in this copy is the *longest* path in the original. To transform the solution of the shortest-paths problem to a solution of the longest-paths problem, negate the weights in the solution. The running time follows immediately from PROPOSITION S.

Using this transformation to develop a class `AcyclicLP` that finds longest paths in edge-weighted DAGs is straightforward. An even simpler way to implement such a class is to copy `AcyclicSP`, then switch the `distTo[]` initialization to `Double.NEGATIVE_INFINITY` and switch the sense of the inequality in `relax()`. Either way, we get an efficient solution to the longest-paths problem in edge-weighted DAGs. This result is to be compared with the fact that the best known algorithm for finding longest simple paths in general edge-weighted digraphs (where edge weights may be negative) requires *exponential* time in the worst case (see CHAPTER 6)! The possibility of cycles seems to make the problem exponentially more difficult.

The figure at right is a trace of the process of finding longest paths in our sample edge-weighted DAG `tinyEW DAG.txt`, for comparison with the shortest-paths trace for the same DAG on page 659. For this example, the algorithm builds the longest-paths tree (LPT) from vertex 5 as follows:

- Does a DFS to discover the topological order 5 1 3 6 4 7 0 2.
- Adds to the tree 5 and all edges leaving it.
- Adds to the tree 1 and 1->3.
- Adds to the tree 3 and edges 3->6 and 3->7. Edge 5->7 becomes ineligible.
- Adds to the tree 6 and edges 6->2, 6->4, and 6->0.
- Adds to the tree 4 and edges 4->0 and 4->7. Edges 6->0 and 3->7 become ineligible.
- Adds to the tree 7 and 7->2. Edge 6->2 becomes ineligible
- Adds 0 to the tree, but not 0->2, which is ineligible.
- Adds 2 to the tree (not depicted).

The longest-paths algorithm processes the vertices in the same order as the shortest-paths algorithm but produces a completely different result.

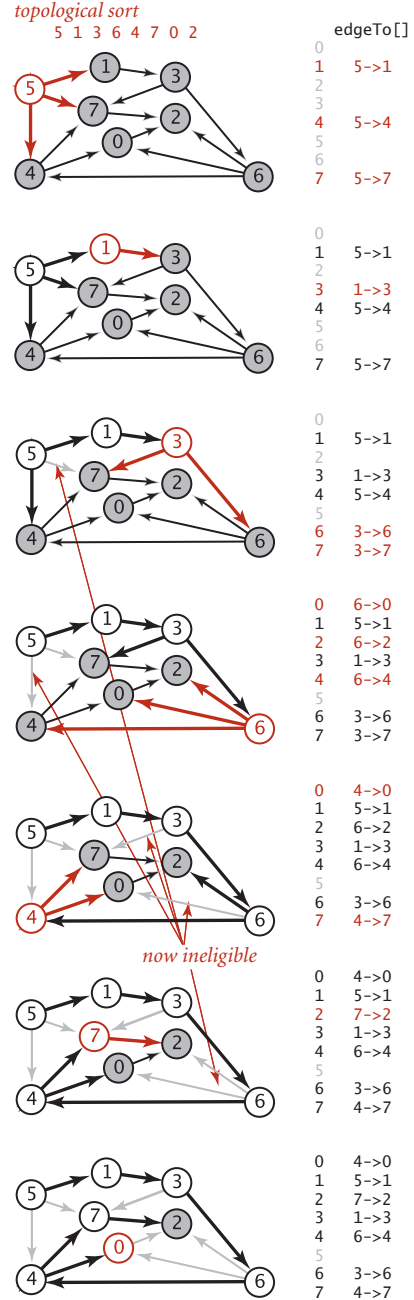

Trace for longest paths in an acyclic network

Parallel job scheduling. As an example application, we revisit the class of *scheduling* problems that we first considered in SECTION 4.2 (page 574). Specifically, consider the following scheduling problem (differences from the problem on page 575 are italicized):

Parallel precedence-constrained scheduling. Given a set of jobs of *specified duration* to be completed, with precedence constraints that specify that certain jobs have to be completed before certain other jobs are begun, how can we schedule the jobs *on identical processors (as many as needed)* such that they are all completed *in the minimum amount of time* while still respecting the constraints?

Implicit in the model of SECTION 4.2 is a single processor: we schedule the jobs in topological order and the total time required is the total duration of the jobs. Now, we assume that we have sufficient processors to perform as many jobs as possible, limited only by precedence constraints. Again, thousands or even millions of jobs might be involved, so we require an efficient algorithm. Remarkably, a *linear-time* algorithm is available—an approach known as the *critical path method* demonstrates that the problem is equivalent to a longest-paths problem in an edge-weighted DAG. This method has been used successfully in countless industrial applications.

We focus on the earliest possible time that we can schedule each job, assuming that any available processor can handle the job for its duration. For example, consider the problem instance specified in the table at right. The solution below shows that 173.0 is the minimum possible completion time for any schedule for this problem: the schedule satisfies all the constraints, and no schedule can complete before time 173.0 because of the job sequence 0->9->6->8->2. This sequence is known as a *critical path* for this problem. Every sequence of jobs, each constrained to follow the job just preceding it in the sequence, represents a lower bound on the length of the schedule. If we define the length of such a sequence to be its earliest possible completion time (total of the durations of its jobs), the longest sequence is known as a critical path because any delay in the starting time of any job delays the best achievable completion time of the entire project.

job	duration	must complete before
0	41.0	1 7 9
1	51.0	2
2	50.0	
3	36.0	
4	38.0	
5	45.0	
6	21.0	3 8
7	32.0	3 8
8	32.0	2
9	29.0	4 6

A job-scheduling problem

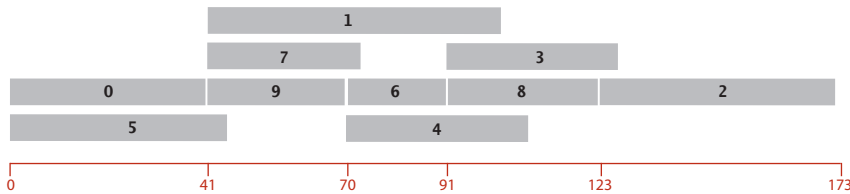

Parallel job-scheduling solution

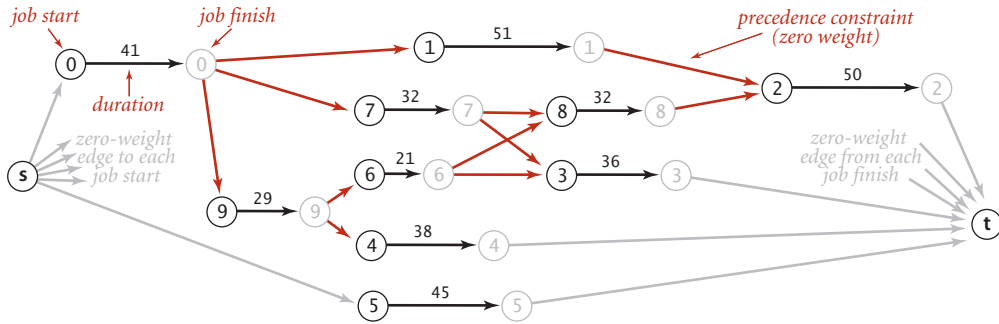

Edge-weighted DAG representation of job scheduling

Definition. The *critical path method* for parallel scheduling is to proceed as follows: Create an edge-weighted DAG with a source s , a sink t , and two vertices for each job (a *start* vertex and an *end* vertex). For each job, add an edge from its start vertex to its end vertex with weight equal to its duration. For each precedence constraint $v \rightarrow w$, add a zero-weight edge from the end vertex corresponding to v to the beginning vertex corresponding to w . Also add zero-weight edges from the source to each job's start vertex and from each job's end vertex to the sink. Now, schedule each job at the time given by the length of its longest path from the source.

The figure at the top of this page depicts this correspondence for our sample problem, and the figure at the bottom of the page gives the longest-paths solution. As specified, the graph has three edges for each job (zero-weight edges from the source and from the finish to the sink, and an edge from start to finish) and one edge for each precedence constraint. The class CPM on the facing page is a straightforward implementation of the critical path method. It transforms any instance of the job-scheduling problem into an instance of the longest-paths problem in an edge-weighted DAG, uses `AcycLiCLP` to solve it, then prints the job start times and schedule finish time.

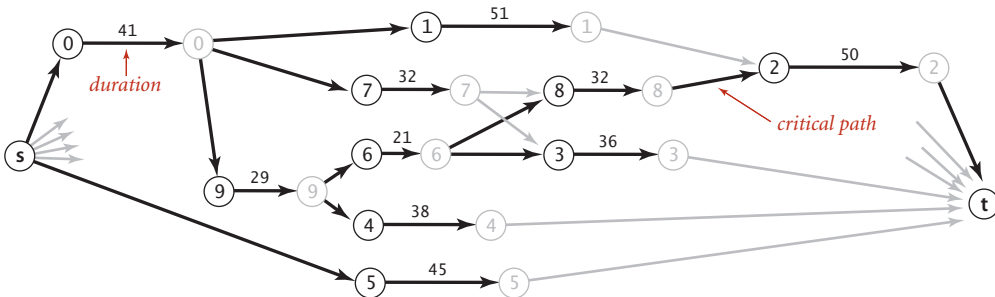

Longest-paths solution to job-scheduling example

Critical path method for parallel precedence-constrained job scheduling

```

public class CPM
{
    public static void main(String[] args)
    {
        int N = StdIn.readInt(); StdIn.readLine();
        EdgeWeightedDigraph G;
        G = new EdgeWeightedDigraph(2*N+2);

        int s = 2*N, t = 2*N+1;
        for (int i = 0; i < N; i++)
        {
            String[] a = StdIn.readLine().split("\\s+");
            double duration = Double.parseDouble(a[0]);
            G.addEdge(new DirectedEdge(i, i+N, duration));
            G.addEdge(new DirectedEdge(s, i, 0.0));
            G.addEdge(new DirectedEdge(i+N, t, 0.0));
            for (int j = 1; j < a.length; j++)
            {
                int successor = Integer.parseInt(a[j]);
                G.addEdge(new DirectedEdge(i+N, successor, 0.0));
            }
        }

        AcyclicLP lp = new AcyclicLP(G, s);

        StdOut.println("Start times:");
        for (int i = 0; i < N; i++)
            StdOut.printf("%4d: %5.1f\n", i, lp.distTo(i));
        StdOut.printf("Finish time: %5.1f\n", lp.distTo(t));
    }
}

```

```

% more jobsPC.txt
10
41.0 1 7 9
51.0 2
50.0
36.0
38.0
45.0
21.0 3 8
32.0 3 8
32.0 2
29.0 4 6

```

This implementation of the critical path method for job scheduling reduces the problem directly to the longest-paths problem in edge-weighted DAGs. It builds an edge-weighted digraph (which must be a DAG) from the job-scheduling problem specification, as prescribed by the critical path method, then uses `AcyclicLP` (see [PROPOSITION T](#)) to find the longest-paths tree and to print the longest-paths lengths, which are precisely the start times for each job.

```

% java CPM < jobsPC.txt
Start times:
0: 0.0
1: 41.0
2: 123.0
3: 91.0
4: 70.0
5: 0.0
6: 70.0
7: 41.0
8: 91.0
9: 41.0
Finish time: 173.0

```

original

job	start
0	0.0
1	41.0
2	123.0
3	91.0
4	70.0
5	0.0
6	70.0
7	41.0
8	91.0
9	41.0

2 by 12.0 after 4

job	start
0	0.0
1	41.0
2	123.0
3	91.0
4	111.0
5	0.0
6	70.0
7	41.0
8	91.0
9	41.0

2 by 70.0 after 7

job	start
0	0.0
1	41.0
2	123.0
3	91.0
4	111.0
5	0.0
6	70.0
7	53.0
8	91.0
9	41.0

4 by 80.0 after 0

infeasible!

Relative deadlines in job scheduling

Proposition U. The critical path method solves the parallel precedence-constrained scheduling problem in linear time.

Proof: Why does the CPM approach work? The correctness of the algorithm rests on two facts. First, every path in the DAG is a sequence of job starts and job finishes, separated by zero-weight precedence constraints—the length of any path from the source s to any vertex v in the graph is a lower bound on the start/finish time represented by v , because we could not do better than scheduling those jobs one after another on the same machine. In particular, the length of the longest path from s to the sink t is a lower bound on the finish time of all the jobs. Second, all the start and finish times implied by longest paths are *feasible*—every job starts after the finish of all the jobs where it appears as a successor in a precedence constraint, because the start time is the length of the *longest* path from the source to it. In particular, the length of the longest path from s to t is an *upper* bound on the finish time of all the jobs. The linear-time performance is immediate from PROPOSITION T.

Parallel job scheduling with relative deadlines. Conventional deadlines are relative to the start time of the first job. Suppose that we allow an additional type of constraint in the job-scheduling problem to specify that a job must begin before a specified amount of time has elapsed, relative to the start time of another job. Such constraints are commonly needed in time-critical manufacturing processes and in many other applications, but they can make the job-scheduling problem considerably more difficult to solve. For example, as shown at left, suppose that we need to add a constraint to our example that job 2 must start no later than 12 time units after job 4 starts. This deadline is actually a constraint on the start time of job 4: it must be no earlier than 12 time units before the start time of job 2. In our example, there is room in the schedule to meet the deadline: we can move the start time of job 4 to 111, 12 time units before the scheduled start time of job 2. Note that, if job 4 were a long job, this change would increase the finish time of the whole schedule. Similarly, if we add to the schedule a deadline that job 2 must start no later than 70 time units after job 7 starts, there is room in the schedule to change the start time of job 7 to 53, without having to reschedule jobs 3 and 8. But if we add a deadline that job 4 must start no later

job	time	relative to
2	12.0	4
2	70.0	7
4	80.0	0

Added deadlines for job scheduling

than 80 time units after job 0, the schedule becomes *infeasible*: the constraints that 4 must start no more than 80 time units after job 0 and that job 2 must start no more than 12 units after job 4 imply that job 2 must start no more than 93 time units after job 0, but job 2 must start at least 123 time units after job 0 because of the chain 0 (41 time units) precedes 9 (29 time units) precedes 6 (21 time units) precedes 8 (32 time units) precedes 2. Adding more deadlines of course multiplies the possibilities and turns an easy problem into a difficult one.

Proposition V. Parallel job scheduling with relative deadlines is a shortest-paths problem in edge-weighted digraphs (with cycles and negative weights allowed).

Proof: Use the same construction as in PROPOSITION U, adding an edge for each deadline: if job v has to start within d time units of the start of job w , add an edge from v to w with *negative* weight d . Then convert to a shortest-paths problem by negating all the weights in the digraph. The proof of correctness applies, *provided that the schedule is feasible*. Determining whether a schedule is feasible is part of the computational burden, as you will see.

This example illustrates that negative weights can play a critical role in practical application models. It says that if we can find an efficient solution to the shortest-paths problem with negative weights, then we can find an efficient solution to the parallel job scheduling problem with relative deadlines. Neither of the algorithms we have considered can do the job: Dijkstra's algorithm requires that weights be positive (or zero), and ALGORITHM 4.10 requires that the digraph be acyclic. Next, we consider the problem of coping with negative edge weights in digraphs that are not necessarily acyclic.

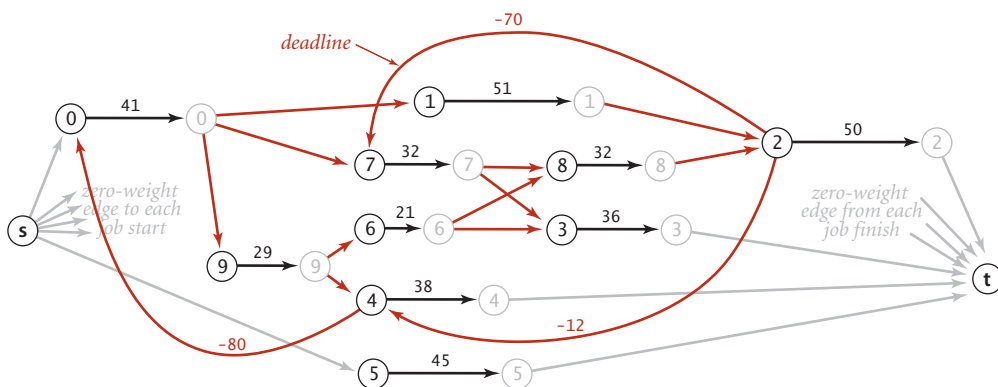

Edge-weighted digraph representation of parallel precedence-constrained scheduling with relative deadlines

Shortest paths in general edge-weighted digraphs Our job-scheduling-with-deadlines example just discussed demonstrates that negative weights are not merely a mathematical curiosity; on the contrary, they significantly extend the applicability of the shortest-paths problem as a problem-solving model. Accordingly we now consider algorithms for edge-weighted digraphs that may have *both* cycles and negative weights.

tinyEWdN.txt

V → 8
E ← 8

```

15
4->5 0.35
5->4 0.35
4->7 0.37
5->7 0.28
7->5 0.28
5->1 0.32
0->4 0.38
0->2 0.26
7->3 0.39
1->3 0.29
2->7 0.34
6->2 -1.20
3->6 0.52
6->0 -1.40
6->4 -1.25

```

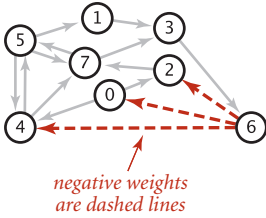

shortest-paths tree from 0

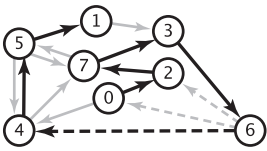

	edgeTo[]	distTo[]
0		
1	5->1	0.93
2	0->2	0.26
3	7->3	0.99
4	6->4	0.26
5	4->5	0.61
6	3->6	1.51
7	2->7	0.60

An edge-weighted digraph with negative weights

Before doing so, we consider some basic properties of such digraphs to reset our intuition about shortest paths. The figure at left is a small example that illustrates the effects of introducing negative weights on a digraph's shortest paths. Perhaps the most important effect is that when negative weights are present, low-weight shortest paths tend to have *more* edges than higher-weight paths. For positive weights, our emphasis was on looking for shortcuts; but when negative weights are present, we seek *detours* that use negative-weight edges. This effect turns our intuition in seeking "short" paths into a liability in understanding the algorithms, so we need to suppress that line of intuition and consider the problem on a basic abstract level.

Strawman I. The first idea that suggests itself is to find the smallest (most negative) edge weight, then to add the absolute value of that number to all the edge weights to transform the digraph into one with no negative weights. This naive approach does not work at all, because shortest

paths in the new digraph bear little relation to shortest paths in the old one. The more edges a path has, the more it is penalized by this transformation (see EXERCISE 4.4.14).

Strawman II. The second idea that suggests itself is to try to adapt Dijkstra's algorithm in some way. The fundamental difficulty with this approach is that the algorithm depends on examining paths in increasing order of their distance from the source. The proof in PROPOSITION R that the algorithm is correct assumes that adding an edge to a path makes that path longer. But any edge with negative weight makes the path *shorter*, so that assumption is unfounded (see EXERCISE 4.4.14).

Negative cycles. When we consider digraphs that could have negative edge weights, the concept of a shortest path is meaningless if there is a cycle in the digraph that

tinyEWDnc.txt

```

V → 8 ← E
15
4 5 0.35
5 4 -0.66
4 7 0.37
5 7 0.28
7 5 0.28
5 1 0.32
0 4 0.38
0 2 0.26
7 3 0.39
1 3 0.29
2 7 0.34
6 2 0.40
3 6 0.52
6 0 0.58
6 4 0.93
    
```

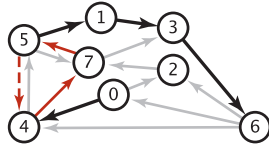

has negative weight. For example, consider the digraph at left, which is identical to our first example except that edge 5→4 has weight $- .66$. Then, the weight of the cycle $4 \rightarrow 7 \rightarrow 5 \rightarrow 4$ is

$$37 + .28 - .66 = - .01$$

We can spin around that cycle to generate arbitrarily short paths! Note that it is not necessary for all the edges on a directed cycle to be of negative weight; what matters is the *sum* of the edge weights.

shortest path from 0 to 6

$0 \rightarrow 4 \rightarrow 7 \rightarrow 5 \rightarrow 4 \rightarrow 7 \rightarrow 5 \dots \rightarrow 1 \rightarrow 3 \rightarrow 6$

An edge-weighted digraph with a negative cycle

Definition. A *negative cycle* in an edge-weighted digraph is a directed cycle whose total weight (sum of the weights of its edges) is negative.

Now, suppose that some vertex on a path from s to a reachable vertex v is also on a negative cycle. In this case, the existence of a shortest path from s to v would be a contradiction, because we could use the cycle to construct a path with weight lower than any given value. In other words, shortest paths can be an ill-posed problem if negative cycles are present.

Proposition W. There exists a shortest path from s to v in an edge-weighted digraph if and only if there exists at least one directed path from s to v *and* no vertex on any directed path from s to v is on a negative cycle.

Proof: See discussion above and EXERCISE 4.4.29.

Note that the requirement that shortest paths have no vertices on negative cycles implies that shortest paths are simple and that we can compute a shortest-paths tree for such vertices, as we have done for positive edge weights.

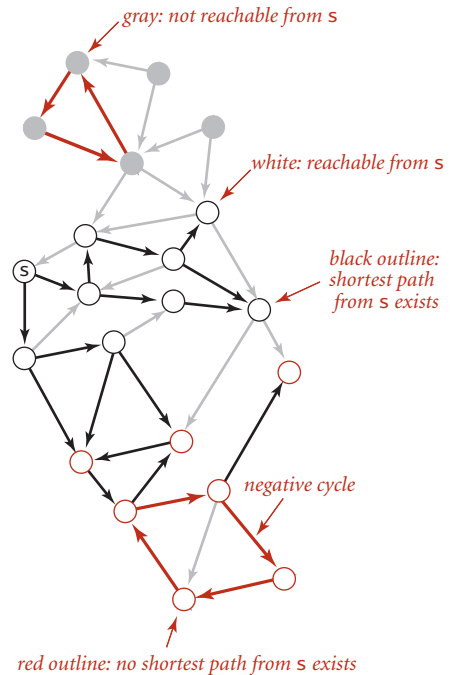

Shortest-paths possibilities

Strawman III. Whether or not there are negative cycles, there exists a shortest *simple* path connecting the source to each vertex reachable from the source. Why not define shortest paths so that we seek such paths? Unfortunately, the best known algorithm for solving this problem takes exponential time in the worst case (see CHAPTER 6). Generally, we consider such problems “too difficult to solve” and study simpler versions.

THUS, A WELL-POSED AND TRACTABLE VERSION of the shortest paths problem in edge-weighted digraphs is to require algorithms to

- Assign a shortest-path weight of $+\infty$ to vertices that are not reachable from the source
- Assign a shortest-path weight of $-\infty$ to vertices that are on a path from the source that has a vertex that is on a negative cycle
- Compute the shortest-path weight (and tree) for all other vertices

Throughout this section, we have been placing restrictions on the shortest-paths problem so that we can develop algorithms to solve it. First, we disallowed negative weights, then we disallowed directed cycles. We now adopt these less stringent restrictions and focus on the following problems in general digraphs:

Negative cycle detection. Does a given edge-weighted digraph have a negative cycle? If it does, find one such cycle.

Single-source shortest paths when negative cycles are not reachable. Given an edge-weighted digraph and a source s with no negative cycles reachable from s , support queries of the form *Is there a directed path from s to a given target vertex v ?* If so, find a *shortest* such path (one whose total weight is minimal).

TO SUMMARIZE: while shortest paths in digraphs with directed cycles is an ill-posed problem and we *cannot* efficiently solve the problem of finding simple shortest paths in such digraphs, we *can* identify negative cycles in practical situations. For example, in a job-scheduling-with-deadlines problem, we might expect negative cycles to be relatively rare: constraints and deadlines derive from logical real-world constraints, so any negative cycles are likely to stem from an error in the problem statement. Finding negative cycles, correcting errors, and then finding the schedule in a problem with no negative cycles is a reasonable way to proceed. In other cases, finding a negative cycle is the goal of the computation. The following approach, developed by R. Bellman and L. Ford in the late 1950s, provides a simple and effective basis for attacking both of these problems and is also effective for digraphs with positive weights:

Proposition X. (Bellman-Ford algorithm) The following method solves the single-source shortest-paths problem from a given source s for any edge-weighted digraph with V vertices and no negative cycles reachable from s : Initialize $\text{distTo}[s]$ to 0 and all other $\text{distTo}[\]$ values to infinity. Then, considering the digraph's edges in any order, relax all edges. Make V such passes.

Proof: For any vertex t that is reachable from s consider a specific shortest path from s to t : $v_0 \rightarrow v_1 \rightarrow \dots \rightarrow v_k$, where v_0 is s and v_k is t . Since there are no negative cycles, such a path exists and k can be no larger than $V - 1$. We show by induction on i that after the i th pass the algorithm computes a shortest path from s to v_i . The base case ($i = 0$) is trivial. Assuming the claim to be true for i , $v_0 \rightarrow v_1 \rightarrow \dots \rightarrow v_i$ is a shortest path from s to v_i , and $\text{distTo}[v_i]$ is its length. Now, we relax every vertex in the i th pass, including v_i , so $\text{distTo}[v_{i+1}]$ is no greater than $\text{distTo}[v_i]$ plus the weight of $v_i \rightarrow v_{i+1}$. Now, after the i th pass, $\text{distTo}[v_{i+1}]$ must be equal to $\text{distTo}[v_i]$ plus the weight of $v_i \rightarrow v_{i+1}$. It cannot be greater because we relax every vertex in the i th pass, in particular v_i , and it cannot be less because that is the length of $v_0 \rightarrow v_1 \rightarrow \dots \rightarrow v_{i+1}$, a shortest path. Thus the algorithm computes a shortest path from s to v_{i+1} after the $(i+1)$ st pass.

Proposition W (continued). The Bellman-Ford algorithm takes time proportional to EV and extra space proportional to V .

Proof: Each of the V passes relaxes E edges.

This method is very general, since it does not specify the order in which the edges are relaxed. We now restrict attention to a less general method where we always relax all the edges leaving any vertex (in any order). The following code exhibits the simplicity of the approach:

```
for (int pass = 0; pass < G.V(); pass++)
    for (v = 0; v < G.V(); v++)
        for (DirectedEdge e : G.adj(v))
            relax(e);
```

We do not consider this version in detail because it *always* relaxes VE edges, and a simple modification makes the algorithm much more efficient for typical applications.

Queue-based Bellman-Ford. Specifically, we can easily determine *a priori* that numerous edges are not going to lead to a successful relaxation in any given pass: the only edges that could lead to a change in `distTo[]` are those leaving a vertex whose `distTo[]` value changed in the previous pass. To keep track of such vertices, we use a FIFO queue. The operation of the algorithm for our standard example with positive weights is shown at right. Shown at the left of the figure are the queue entries for each pass (in red), followed by the queue entries for the next pass (in black). We start with the source on the queue and then compute the SPT as follows:

- Relax 1->3 and put 3 on the queue.
- Relax 3->6 and put 6 on the queue.
- Relax 6->4, 6->0, and 6->2 and put 4, 0, and 2 on the queue.
- Relax 4->7 and 4->5 and put 7 and 4 on the queue. Then relax 0->4 and 0->2, which are ineligible. Then relax 2->7 (and recolor 4->7).
- Relax 7->5 (and recolor 4->5) but do not put 5 on the queue (it is already there). Then relax 7->3, which is ineligible. Then relax 5->4, and 5->7, which are ineligible, leaving the queue empty.

Implementation. Implementing the Bellman-Ford algorithm along these lines requires remarkably little code, as shown in ALGORITHM 4.11. It is based on two additional data structures:

- A queue `q` of vertices to be relaxed
- A vertex-indexed boolean array `onQ[]` that indicates which vertices are on the queue, to avoid duplicates

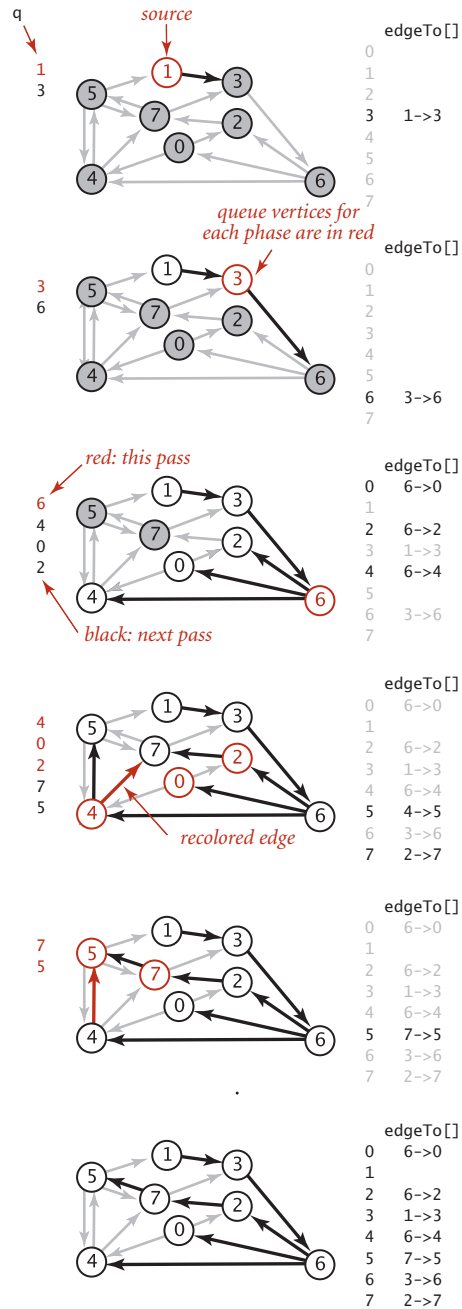

Trace of the Bellman-Ford algorithm

We start by putting the source s on the queue, then enter a loop where we take a vertex off the queue and relax it. To add vertices to the queue, we augment our `relax()` implementation from page 646 to put the vertex pointed to by any edge that successfully relaxes onto the queue, as shown in the code at right. The data structures ensure that

- Only one copy of each vertex appears on the queue
- Every vertex whose `edgeTo[]` and `distTo[]` values change in some pass is processed in the next pass

To complete the implementation, we need to ensure that the algorithm terminates after V passes. One way to achieve this end is to explicitly keep track of the passes. Our implementation `BellmanFordSP` (ALGORITHM 4.11) uses a different approach that we will consider in detail on page 677: it checks for negative cycles in the subset of digraph edges in `edgeTo[]` and terminates if it finds one.

```
private void relax(EdgeWeightedDigraph G, int v)
{
    for (DirectedEdge e : G.adj(v))
    {
        int w = e.to();
        if (distTo[w] > distTo[v] + e.weight())
        {
            distTo[w] = distTo[v] + e.weight();
            edgeTo[w] = e;
            if (!onQ[w])
            {
                q.enqueue(w);
                onQ[w] = true;
            }
        }
    }
    if (cost++ % G.V() == 0)
        findNegativeCycle();
}
}
```

Relaxation for Bellman-Ford

Proposition Y. The queue-based implementation of the Bellman-Ford algorithm solves the shortest-paths problem from a given source s (or finds a negative cycle reachable from s) for any edge-weighted digraph with V vertices, in time proportional to EV and extra space proportional to V , in the worst case.

Proof: If there is no negative cycle reachable from s , the algorithm terminates after relaxations corresponding to the $(V-1)$ st pass of the generic algorithm described in PROPOSITION X (since all shortest paths have fewer than $V-1$ edges). If there does exist a negative cycle reachable from s , the queue never empties. After relaxations corresponding to the V th pass of the generic algorithm described in PROPOSITION X the `edgeTo[]` array has a path with a cycle (connects some vertex w to itself) and that cycle must be negative, since the path from s to the second occurrence of w must be shorter than the path from s to the first occurrence of w for w to be included on the path the second time. In the worst case, the algorithm mimics the general algorithm and relaxes all E edges in each of V passes.

ALGORITHM 4.11 Bellman-Ford algorithm (queue-based)

```

public class BellmanFordSP
{
    private double[] distTo;           // length of path to v
    private DirectedEdge[] edgeTo;    // last edge on path to v
    private boolean[] onQ;            // Is this vertex on the queue?
    private Queue<Integer> queue;     // vertices being relaxed
    private int cost;                 // number of calls to relax()
    private Iterable<DirectedEdge> cycle; // negative cycle in edgeTo[]?

    public BellmanFordSP(EdgeWeightedDigraph G, int s)
    {
        distTo = new double[G.V()];
        edgeTo = new DirectedEdge[G.V()];
        onQ = new boolean[G.V()];
        queue = new Queue<Integer>();
        for (int v = 0; v < G.V(); v++)
            distTo[v] = Double.POSITIVE_INFINITY;
        distTo[s] = 0.0;
        queue.enqueue(s);
        onQ[s] = true;
        while (!queue.isEmpty() && !this.hasNegativeCycle())
        {
            int v = queue.dequeue();
            onQ[v] = false;
            relax(v);
        }
    }

    private void relax(int v)
    // See page 673.

    public double distTo(int v) // standard client query methods
    public boolean hasPathTo(int v) // for SPT implementations
    public Iterable<Edge> pathTo(int v) // (See page 649.)

    private void findNegativeCycle()
    public boolean hasNegativeCycle()
    public Iterable<Edge> negativeCycle()
    // See page 677.
}

```

This implementation of the Bellman-Ford algorithm uses a version of `relax()` that puts vertices pointed to by edges that successfully relax on a FIFO queue (avoiding duplicates) and periodically checks for a negative cycle in `edgeTo[]` (see text).

The queue-based Bellman-Ford algorithm is an effective and efficient method for solving the shortest-paths problem that is widely used in practice, even for the case when edge weights are positive. For example, as shown in the diagram at right, our 250-vertex example is complete in 14 passes and requires fewer path-length compares than Dijkstra's algorithm for the same problem.

Negative weights. The example on the next page traces the progress of the Bellman-Ford algorithm in a digraph with negative weights. We start with the source on q and then compute the SPT as follows:

- Relax $0 \rightarrow 2$ and $0 \rightarrow 4$ and put 2 and 4 on the queue.
- Relax $2 \rightarrow 7$ and put 7 on the queue. Then relax $4 \rightarrow 5$ and put 5 on the queue. Then relax $4 \rightarrow 7$, which is ineligible.
- Relax $7 \rightarrow 3$ and $5 \rightarrow 1$ and put 3 and 1 on the queue. Then relax $5 \rightarrow 4$ and $5 \rightarrow 7$, which are ineligible.
- Relax $3 \rightarrow 6$ and put 6 on the queue. Then relax $1 \rightarrow 3$, which is ineligible.
- Relax $6 \rightarrow 4$ and put 4 on the queue. This negative-weight edge gives a shorter path to 4, so its edges must be relaxed again (they were first relaxed in pass 2). The distances to 5 and to 1 are no longer valid but will be corrected in later passes.
- Relax $4 \rightarrow 5$ and put 5 on the queue. Then relax $4 \rightarrow 7$, which is still ineligible.
- Relax $5 \rightarrow 1$ and put 1 on the queue. Then relax $5 \rightarrow 4$ and $5 \rightarrow 7$, which are both still ineligible.
- Relax $1 \rightarrow 3$, which is still ineligible, leaving the queue empty.

The shortest-paths tree for this example is a single long path from 0 to 1. The edges from 4, 5, and 1 are all relaxed twice for this example. Rereading the proof of PROPOSITION X in the context of this example is a good way to better understand it.

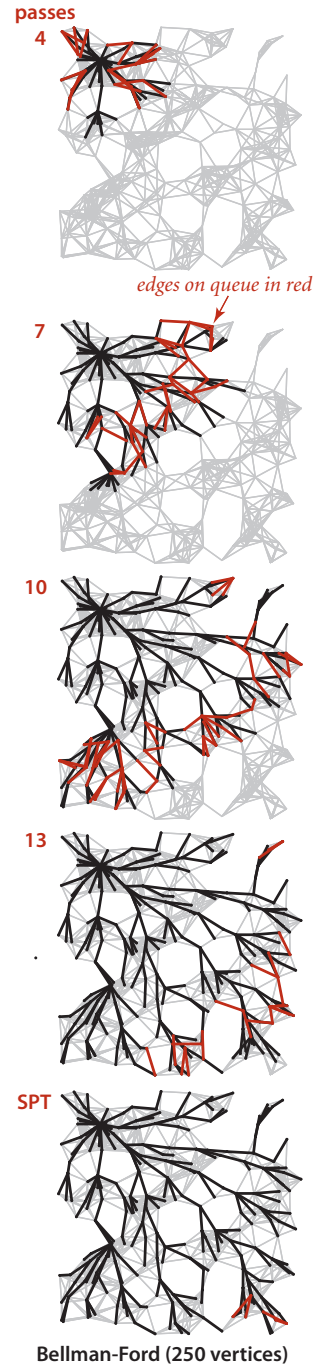

tinyEWDn.txt

```

4->5 0.35
5->4 0.35
4->7 0.37
5->7 0.28
7->5 0.28
5->1 0.32
0->4 0.38
0->2 0.26
7->3 0.39
1->3 0.29
2->7 0.34
2->7 0.34
6->2 -1.20
3->6 0.52
6->0 -1.40
6->4 -1.25
    
```

queue

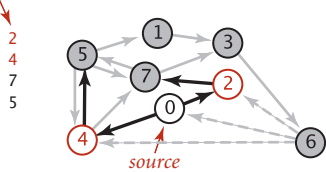

edgeTo[]	distTo[]
0	
1	
2	0->2 0.26
3	
4	0->4 0.38
5	4->5 0.73
6	
7	2->7 0.60

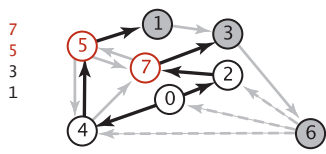

edgeTo[]	distTo[]
0	
1	5->1 1.05
2	0->2 0.26
3	7->3 0.99
4	0->4 0.38
5	4->5 0.73
6	
7	2->7 0.60

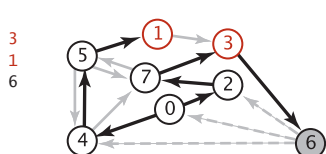

edgeTo[]	distTo[]
0	
1	5->1 1.05
2	0->2 0.26
3	7->3 0.99
4	0->4 0.38
5	4->5 0.73
6	3->6 1.51
7	2->7 0.60

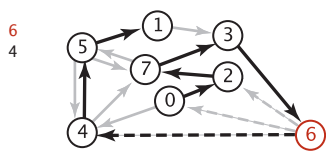

edgeTo[]	distTo[]
0	
1	5->1 1.05
2	0->2 0.26
3	7->3 0.99
4	6->4 0.26
5	4->5 0.73
6	3->6 1.51
7	2->7 0.60

no longer eligible!

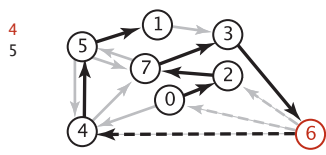

edgeTo[]	distTo[]
0	
1	5->1 1.05
2	0->2 0.26
3	7->3 0.99
4	6->4 0.26
5	4->5 0.61
6	3->6 1.51
7	2->7 0.60

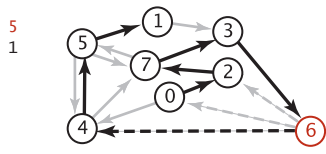

edgeTo[]	distTo[]
0	
1	5->1 0.93
2	0->2 0.26
3	7->3 0.99
4	6->4 0.26
5	4->5 0.61
6	3->6 1.51
7	2->7 0.60

Trace of the Bellman-Ford algorithm (negative weights)

Negative cycle detection. Our implementation `BellmanFordSP` checks for negative cycles to avoid an infinite loop. We can apply the code that does this check to provide clients with the capability to check for and extract negative cycles, as well. We do so by adding the following methods to the SP API on page 644:

```
boolean hasNegativeCycle() has a negative cycle?
Iterable<DirectedEdge> negativeCycle() a negative cycle
(null if no negative cycles)
```

Shortest -paths API extensions for handling negative cycles

Implementing these methods is not difficult, as shown in the code below. After running the constructor in `BellmanFordSP`, the proof of PROPOSITION Y tells us that the digraph has a negative cycle reachable from the source if and only if the queue is nonempty after the V th pass through all the edges. Moreover, the subgraph of edges in our `edgeTo[]` array must contain a negative cycle. Accordingly, to implement `negativeCycle()` we build an edge-weighted digraph from the edges in `edgeTo[]` and look for a cycle in that digraph. To find the cycle, we use a version of `DirectedCycle` from SECTION 4.3, adapted to work for edge-weighted digraphs (see EXERCISE 4.4.12). We amortize the cost of this check by

- Adding an instance variable `cycle` and a private method `findNegativeCycle()` that sets `cycle` to an iterator for the edges of a negative cycle if one is found (and to `null` if none is found)
- Calling `findNegativeCycle()` every V th call to `relax()`

This approach ensures that the loop in the constructor terminates. Moreover, clients can call `hasNegativeCycle()` to learn whether there is a negative cycle reachable from the source (and `negativeCycle()` to get one such cycle. Adding the capability to detect any negative cycle in the digraph is also a simple extension (see EXERCISE 4.4.43).

```
private void findNegativeCycle()
{
    int V = edgeTo.length;
    EdgeWeightedDigraph spt;
    spt = new EdgeWeightedDigraph(V);
    for (int v = 0; v < V; v++)
        if (edgeTo[v] != null)
            spt.addEdge(edgeTo[v]);

    EdgeWeightedCycleFinder cf;
    cf = new EdgeWeightedCycleFinder(spt);
    cycle = cf.cycle();
}

public boolean hasNegativeCycle()
{ return cycle != null; }

public Iterable<Edge> negativeCycle()
{ return cycle; }
```

Negative cycle detection methods for Bellman-Ford algorithm

The example below traces the progress of the Bellman-Ford algorithm in a digraph with a negative cycle. The first two passes are the same as for `tinyEWDn.txt`. In the third pass, after relaxing `7->3` and `5->1` and putting 3 and 1 on queue, it relaxes the negative-weight edge `5->4`. *This relaxation discovers the negative cycle `4->5->4`.* It puts `5->4` on the tree and cuts the cycle off from the source 0 in `edgeTo[]`. From that point on, the algorithm spins through the cycle, lowering the distances to all the vertices touched, until finishing when the cycle is detected, with the queue not empty. The cycle is in the `edgeTo[]` array, for discovery by `findNegativeCycle()`.

tinyEWDnc.txt

```

4->5 0.35
5->4 -0.66
4->7 0.37
5->7 0.28
7->5 0.28
5->1 0.32
0->4 0.38
0->2 0.26
7->3 0.39
1->3 0.29
2->7 0.34
6->2 0.40
3->6 0.52
6->0 0.58
6->4 0.93
    
```

queue

2
4
7
5

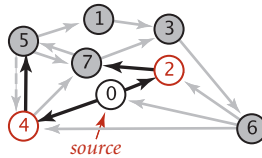

edgeTo[] distTo[]

```

0
1
2 0->2 0.26
3
4 0->4 0.38
5 4->5 0.73
6
7 2->7 0.60
    
```

7
5
3
1
4

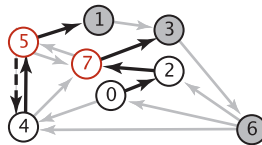

edgeTo[] distTo[]

```

0
1 5->1 1.05
2 0->2 0.26
3 7->3 0.99
4 5->4 0.07
5 4->5 0.73
6
7 2->7 0.60
    
```

length of
0->4->5->4

3
1
4
6
7
5

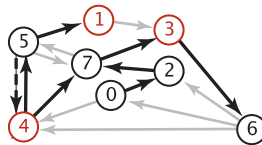

edgeTo[] distTo[]

```

0
1 5->1 1.05
2 0->2 0.26
3 7->3 0.99
4 0->4 0.07
5 4->5 0.42
6 3->6 1.51
7 2->7 0.44
    
```

6
7
5
3
1
4

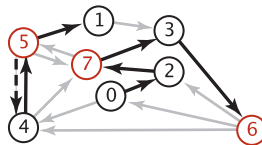

edgeTo[] distTo[]

```

0
1 5->1 0.74
2 0->2 0.26
3 7->3 0.83
4 5->4 -0.59
5 4->5 0.73
6 3->6 1.51
7 2->7 0.60
    
```

length of
0->4->5->4->5->4

...

Trace of the Bellman-Ford algorithm (negative cycle)

Arbitrage. Consider a market for financial transactions that is based on trading commodities. You can find a familiar example in tables that show conversion rates among currencies, such as the one in our sample file `rates.txt` shown here. The first line in the file is the number V of currencies; then the file has one line per currency, giving its name followed by the conversion rates to the other currencies. For brevity, this example includes just five of the hundreds of currencies that are traded on modern markets: U.S. dollars (USD), Euros (EUR), British pounds (GBP), Swiss francs (CHF), and Canadian dollars (CAD). The t th number on line s represents a conversion rate: the number of units of the currency named on row s that is needed to buy 1 unit of the currency named on row t . For example, our table says that 1,000 U.S. dollars will buy 741 euros. This table is equivalent to a *complete edge-weighted digraph* with a vertex corresponding to each currency and an edge corresponding to each conversion rate. An edge $s \rightarrow t$ with weight x corresponds to a conversion from s to t at exchange rate x . Paths in the digraph specify multistep conversions. For example, combining the conversion just mentioned with an edge $t \rightarrow u$ with weight y gives a path $s \rightarrow t \rightarrow u$ that represents a way to convert 1 unit of currency s into xy units of currency u . For example, we might buy 1,012.206 = 741 × 1.366 Canadian dollars with our euros. Note that this gives a better rate than directly converting from U.S. dollars to Canadian dollars. You might expect xy to be equal to the weight of $s \rightarrow u$ in all such cases, but such tables represent a complex financial system where such consistency cannot be guaranteed. Thus, finding the path from s to u such that the product of the weights is maximal is certainly of interest. Even more interesting is a case where the product of the edge weights is *smaller* than the weight of the edge from the last vertex back to the first. In our example, suppose that the weight of $u \rightarrow s$ is z and $xyz > 1$. Then cycle $s \rightarrow t \rightarrow u \rightarrow s$ gives a way to convert 1 unit of currency s into more than 1 unit (xyz) of currency s . In other words, we can make a $100(xyz - 1)$ percent profit by converting from s to t to u back to s . For example, if we convert our 1,012.206 Canadian dollars back to US dollars, we get $1,012.206 \cdot .995 = 1,007.14497$ dollars, a 7.14497-dollar profit. That might not seem like

```
% more rates.txt
5
USD 1      0.741  0.657  1.061  1.005
EUR 1.349  1      0.888  1.433  1.366
GBP 1.521  1.126  1      1.614  1.538
CHF 0.942  0.698  0.619  1      0.953
CAD 0.995  0.732  0.650  1.049  1
```

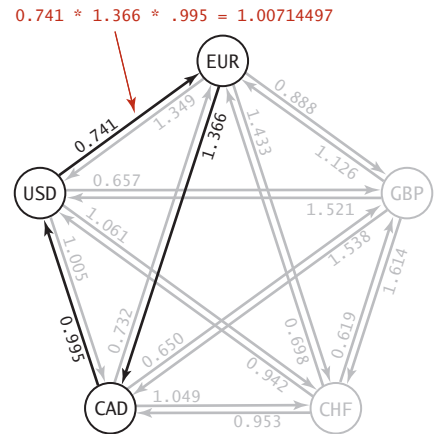

An arbitrage opportunity

For example, if we convert our 1,012.206 Canadian dollars back to US dollars, we get $1,012.206 \cdot .995 = 1,007.14497$ dollars, a 7.14497-dollar profit. That might not seem like

Arbitrage in currency exchange

```
public class Arbitrage
{
    public static void main(String[] args)
    {
        int V = StdIn.readInt();
        String[] name = new String[V];
        EdgeWeightedDigraph G = new EdgeWeightedDigraph(V);
        for (int v = 0; v < V; v++)
        {
            name[v] = StdIn.readString();
            for (int w = 0; w < V; w++)
            {
                double rate = StdIn.readDouble();
                DirectedEdge e = new DirectedEdge(v, w, -Math.log(rate));
                G.addEdge(e);
            }
        }
        BellmanFordSP spt = new BellmanFordSP(G, 0);
        if (spt.hasNegativeCycle())
        {
            double stake = 1000.0;
            for (DirectedEdge e : spt.negativeCycle())
            {
                StdOut.printf("%10.5f %s ", stake, name[e.from()]);
                stake *= Math.exp(-e.weight());
                StdOut.printf("= %10.5f %s\n", stake, name[e.to()]);
            }
        }
        else StdOut.println("No arbitrage opportunity");
    }
}
```

This `BellmanFordSP` client finds an arbitrage opportunity in a currency exchange table by constructing a complete-graph representation of the exchange table and then using the Bellman-Ford algorithm to find a negative cycle in the graph.

```
% java Arbitrage < rates.txt
1000.00000 USD = 741.00000 EUR
 741.00000 EUR = 1012.20600 CAD
1012.20600 CAD = 1007.14497 USD
```

much, but a currency trader might have 1 million dollars and be able to execute these transactions every minute, which would lead to profits of over \$7,000 per minute, or \$420,000 per hour! This situation is an example of an *arbitrage* opportunity that would allow traders to make unlimited profits were it not for forces outside the model, such as transaction fees or limitations on the size of transactions. Even with these forces, arbitrage is plenty profitable in the real world. What does this problem have to do with shortest paths? The answer to this question is remarkably simple:

Proposition Z. The arbitrage problem is a negative-cycle-detection problem in edge-weighted digraphs.

Proof: Replace each weight by its *logarithm*, negated. With this change, computing path weights by multiplying edge weights in the original problem corresponds to adding them in the transformed problem. Specifically, any product $w_1 w_2 \dots w_k$ corresponds to a sum $-\ln(w_1) - \ln(w_2) - \dots - \ln(w_k)$. The transformed edge weights might be negative or positive, a path from v to w gives a way of converting from currency v to currency w , and any negative cycle is an arbitrage opportunity.

In our example, where all transactions are possible, the digraph is a complete graph, so any negative cycle is reachable from any vertex. In general commodity exchanges, some edges may be absent, so the one-argument constructor described in EXERCISE 4.4.43 is needed. No efficient algorithm for finding the *best* arbitrage opportunity (the most negative cycle in a digraph) is known (and the graph does not have to be very big for this computational burden to be overwhelming), but the fastest algorithm to find *any* arbitrage opportunity is crucial—a trader with that algorithm is likely to systematically wipe out numerous opportunities before the second-fastest algorithm finds any.

THE TRANSFORMATION IN THE PROOF OF PROPOSITION Z is useful even in the absence of arbitrage, because it reduces currency conversion to a shortest-paths problem. Since the logarithm function is monotonic (and we negated the logarithms), the product is maximized precisely when the sum is minimized. The edge weights might be negative or positive, and a shortest path from v to w gives a best way of converting from currency v to currency w .

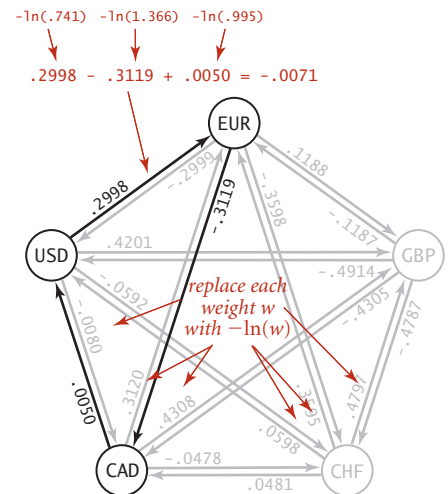

A negative cycle that represents an arbitrage opportunity

Perspective The table below summarizes the important characteristics of the shortest-paths algorithms that we have considered in this section. The first reason to choose among the algorithms has to do with basic properties of the digraph at hand. Does it have negative weights? Does it have cycles? Does it have negative cycles? Beyond these basic characteristics, the characteristics of edge-weighted digraphs can vary widely, so choosing among the algorithms requires some experimentation when more than one can apply.

algorithm	restriction	path length compares (order of growth)		extra space	sweet spot
		typical	worst case		
<i>Dijkstra (eager)</i>	positive edge weights	$E \log V$	$E \log V$	V	worst-case guarantee
<i>topological sort</i>	edge-weighted DAGs	$E + V$	$E + V$	V	optimal for acyclic
<i>Bellman-Ford (queue-based)</i>	no negative cycles	$E + V$	VE	V	widely applicable

Performance characteristics of shortest-paths algorithms

Historical notes. Shortest-paths problems have been intensively studied and widely used since the 1950s. The history of Dijkstra's algorithm for computing shortest paths is similar (and related) to the history of Prim's algorithm for computing the MST. The name *Dijkstra's algorithm* is commonly used to refer both to the abstract method of building an SPT by adding vertices in order of their distance from the source and to its implementation as the optimal algorithm for the adjacency-matrix representation, because E. W. Dijkstra presented both in his 1959 paper (and also showed that the same approach could compute the MST). Performance improvements for sparse graphs are dependent on later improvements in priority-queue implementations that are not specific to the shortest-paths problem. Improved performance of Dijkstra's algorithm is one of the most important applications of that technology (for example, with a data structure known as a *Fibonacci heap*, the worst-case bound can be reduced to $E + V \log V$). The Bellman-Ford algorithm has proven to be useful in practice and has found wide application, particularly for general edge-weighted digraphs. While the running time of the Bellman-Ford algorithm is likely to be linear for typical applications, its worst-case running time is VE . The development of a worst-case linear-time shortest-paths algorithm for sparse graphs remains an open problem. The basic Bellman-Ford algorithm

was developed in the 1950s by L. Ford and R. Bellman; despite the dramatic strides in performance that we have seen for many other graph problems, we have not yet seen algorithms with better worst-case performance for digraphs with negative edge weights (but no negative cycles).

Q&A

Q. Why define separate data types for undirected graphs, directed graphs, edge-weighted undirected graphs, and edge-weighted digraphs?

A. We do so both for clarity in client code and for simpler and more efficient implementation code in unweighted graphs. In applications or systems where all types of graphs are to be processed, it is a textbook exercise in software engineering to define an ADT from which ADTs can be derived for `Graph`, the unweighted undirected graphs of SECTION 4.1; `Digraph`, the unweighted digraphs of SECTION 4.2; `EdgeWeightedGraph`, the edge-weighted undirected graphs of SECTION 4.3; or `EdgeWeightedDigraph`, the edge-weighted directed graphs of this section.

Q. How can we find shortest paths in undirected (edge-weighted) graphs?

A. For positive edge weights, Dijkstra's algorithm does the job. We just build an `EdgeWeightedDigraph` corresponding to the given `EdgeWeightedGraph` (by adding two directed edges corresponding to each undirected edge, one in each direction) and then run Dijkstra's algorithm. If edge weights can be negative, efficient algorithms are available, but they are more complicated than the Bellman-Ford algorithm.

EXERCISES

- 4.4.1** True or false: Adding a constant to every edge weight does not change the solution to the single-source shortest-paths problem.
- 4.4.2** Provide an implementation of `toString()` for `EdgeWeightedDigraph`.
- 4.4.3** Develop an implementation of `EdgeWeightedDigraph` for dense graphs that uses an adjacency-matrix (two-dimensional array of weights) representation (see EXERCISE 4.3.9). Ignore parallel edges.
- 4.4.4** Draw the SPT for source 0 of the edge-weighted digraph obtained by deleting vertex 7 from `tinyEWD.txt` (see page 644), and give the parent-link representation of the SPT. Answer the question for the same graph with all edge reversed.
- 4.4.5** Change the direction of edge 0→2 in `tinyEWD.txt` (see page 644). Draw two different SPTs that are rooted at 2 for this modified edge-weighted digraph.
- 4.4.6** Give a trace that shows the process of computing the SPT of the digraph defined in EXERCISE 4.4.5 with the eager version of Dijkstra's algorithm.
- 4.4.7** Develop a version of `DijkstraSP` that supports a client method that returns a *second* shortest path from `s` to `t` in an edge-weighted digraph (and returns `null` if there is only one shortest path from `s` to `t`).
- 4.4.8** The *diameter* of a digraph is the length of the maximum-length shortest path connecting two vertices. Write a `DijkstraSP` client that finds the diameter of a given `EdgeWeightedDigraph` that has nonnegative weights.
- 4.4.9** The table below, from an old published road map, purports to give the length of the shortest routes connecting the cities. It contains an error. Correct the table. Also, add a table that shows how to achieve the shortest routes.

	Providence	Westerly	New London	Norwich
Providence	-	53	54	48
Westerly	53	-	18	101
New London	54	18	-	12
Norwich	48	101	12	-

EXERCISES *(continued)*

4.4.10 Consider the edges in the digraph defined in EXERCISE 4.4.4 to be undirected edges such that each edge corresponds to equal-weight edges in both directions in the edge-weighted digraph. Answer EXERCISE 4.4.6 for this corresponding edge-weighted digraph.

4.4.11 Use the memory-cost model of SECTION 1.4 to determine the amount of memory used by `EdgeWeightedDigraph` to represent a graph with V vertices and E edges.

4.4.12 Adapt the `DirectedCycle` and `Topological` classes from SECTION 4.2 to use the `EdgeWeightedDigraph` and `DirectedEdge` APIs of this section, thus implementing `EdgeWeightedCycleFinder` and `EdgeWeightedTopological` classes.

4.4.13 Show, in the style of the trace in the text, the process of computing the SPT with Dijkstra's algorithm for the digraph obtained by removing the edge 5→7 from `tinyEWD.txt` (see page 644).

4.4.14 Show the paths that would be discovered by the two strawman approaches described on page 668 for the example `tinyEWDn.txt` shown on that page.

4.4.15 What happens to Bellman-Ford if there is a negative cycle on the path from s to v and then you call `pathTo(v)`?

4.4.16 Suppose that we convert an `EdgeWeightedGraph` into an `EdgeWeightedDigraph` by creating two `DirectedEdge` objects in the `EdgeWeightedDigraph` (one in each direction) for each `Edge` in the `EdgeWeightedGraph` (as described for Dijkstra's algorithm in the Q&A on page 684) and then use the Bellman-Ford algorithm. Explain why this approach fails spectacularly.

4.4.17 What happens if you allow a vertex to be enqueued more than once in the same pass in the Bellman-Ford algorithm?

Answer: The running time of the algorithm can go exponential. For example, describe what happens for the complete edge-weighted digraph whose edge weights are all -1 .

4.4.18 Write a CPM client that prints all critical paths.

4.4.19 Find the lowest-weight cycle (best arbitrage opportunity) in the example shown in the text.

4.4.20 Find a currency-conversion table online or in a newspaper. Use it to build an arbitrage table. *Note:* Avoid tables that are derived (calculated) from a few values and that therefore do not give sufficiently accurate conversion information to be interesting. *Extra credit:* Make a killing in the money-exchange market!

4.4.21 Show, in the style of the trace in the text, the process of computing the SPT with the Bellman-Ford algorithm for the edge-weighted digraph of EXERCISE 4.4.5.

CREATIVE PROBLEMS

4.4.22 *Vertex weights.* Show that shortest-paths computations in edge-weighted digraphs with nonnegative weights on vertices (where the weight of a path is defined to be the sum of the weights of the vertices) can be handled by building an edge-weighted digraph that has weights on only the edges.

4.4.23 *Source-sink shortest paths.* Develop an API and implementation that use a version of Dijkstra's algorithm to solve the *source-sink* shortest path problem on edge-weighted digraphs.

4.4.24 *Multisource shortest paths.* Develop an API and implementation that uses Dijkstra's algorithm to solve the *multisource* shortest-paths problem on edge-weighted digraphs with positive edge weights: given a *set* of sources, find a shortest-paths forest that enables implementation of a method that returns to clients the shortest path from any source to each vertex. *Hint:* Add a dummy vertex with a zero-weight edge to each source, or initialize the priority queue with all sources, with their `distTo[]` entries set to 0.

4.4.25 *Shortest path between two subsets.* Given a digraph with positive edge weights, and two distinguished subsets of vertices S and T , find a shortest path from any vertex in S to any vertex in T . Your algorithm should run in time proportional to $E \log V$, in the worst case.

4.4.26 *Single-source shortest paths in dense graphs.* Develop a version of Dijkstra's algorithm that can find the SPT from a given vertex in a dense edge-weighted digraph in time proportional to V^2 . Use an adjacency-matrix representation (see EXERCISE 4.4.3 and EXERCISE 4.3.29).

4.4.27 *Shortest paths in Euclidean graphs.* Adapt our APIs to speed up Dijkstra's algorithm in the case where it is known that vertices are points in the plane.

4.4.28 *Longest paths in DAGs.* Develop an implementation `AcyclicLP` that can solve the *longest-paths* problem in edge-weighted DAGs, as described in PROPOSITION T.

4.4.29 *General optimality.* Complete the proof of PROPOSITION W by showing that if there exists a directed path from s to v and no vertex on any path from s to v is on a negative cycle, then there exists a shortest path from s to v (*Hint:* See PROPOSITION P.)

4.4.30 *All-pairs shortest path in graphs with negative cycles.* Articulate an API like the one implemented on page 656 for the all-pairs shortest-paths problem in graphs with no

negative cycles. Develop an implementation that runs a version of Bellman-Ford to identify weights $\pi_i[v]$ such that for any edge $v \rightarrow w$, the edge weight plus the difference between $\pi_i[v]$ and $\pi_i[w]$ is nonnegative. Then use these weights to reweight the graph, so that Dijkstra's algorithm is effective for finding all shortest paths in the reweighted graph.

4.4.31 *All-pairs shortest path on a line.* Given a weighted line graph (undirected connected graph, all vertices of degree 2, except two endpoints which have degree 1), devise an algorithm that preprocesses the graph in linear time and can return the distance of the shortest path between any two vertices in constant time.

4.4.32 *Parent-checking heuristic.* Modify Bellman-Ford to visit a vertex v only if its SPT parent $\text{edgeTo}[v]$ is not currently on the queue. This heuristic has been reported by Cherkassky, Goldberg, and Radzik to be useful in practice. Prove that it correctly computes shortest paths and that the worst-case running time is proportional to EV .

4.4.33 *Shortest path in a grid.* Given an N -by- N matrix of positive integers, find the shortest path from the $(0, 0)$ entry to the $(N-1, N-1)$ entry, where the length of the path is the sum of the integers in the path. Repeat the problem but assume you can only move right and down.

4.4.34 *Monotonic shortest path.* Given a weighted digraph, find a *monotonic* shortest path from s to every other vertex. A path is monotonic if the weight of every edge on the path is either strictly increasing or strictly decreasing. The path should be simple (no repeated vertices). *Hint:* Relax edges in ascending order and find a best path; then relax edges in descending order and find a best path.

4.4.35 *Bitonic shortest path.* Given a digraph, find a *bitonic* shortest path from s to every other vertex (if one exists). A path is bitonic if there is an intermediate vertex v such that the edges on the path from s to v are strictly increasing and the edges on the path from v to t are strictly decreasing. The path should be simple (no repeated vertices).

4.4.36 *Neighbors.* Develop an SP client that finds all vertices within a given distance d of a given vertex in a given edge-weighted digraph. The running time of your method should be proportional to the size of the subgraph induced by those vertices and the vertices incident on them, or V (to initialize data structures), whichever is larger.

CREATIVE PROBLEMS *(continued)*

4.4.37 *Critical edges.* Develop an algorithm for finding an edge whose removal causes maximal increase in the shortest-paths length from one given vertex to another given vertex in a given edge-weighted digraph.

4.4.38 *Sensitivity.* Develop an SP client that performs a sensitivity analysis on the edge-weighted digraph's edges with respect to a given pair of vertices s and t : Compute a V -by- V boolean matrix such that, for every v and w , the entry in row v and column w is `true` if $v \rightarrow w$ is an edge in the edge-weighted digraphs whose weight can be increased without the shortest-path length from v to w being increased and is `false` otherwise.

4.4.39 *Lazy implementation of Dijkstra's algorithm.* Develop an implementation of the lazy version of Dijkstra's algorithm that is described in the text.

4.4.40 *Bottleneck SPT.* Show that an MST of an undirected graph is equivalent to a bottleneck SPT of the graph: For every pair of vertices v and w , it gives the path connecting them whose longest edge is as short as possible.

4.4.41 *Bidirectional search.* Develop a class for the source-sink shortest-paths problem that is based on code like ALGORITHM 4.9 but that initializes the priority queue with both the source and the sink. Doing so leads to the growth of an SPT from each vertex; your main task is to decide precisely what to do when the two SPTs collide.

4.4.42 *Worst case (Dijkstra).* Describe a family of graphs with V vertices and E edges for which the worst-case running time of Dijkstra's algorithm is achieved.

4.4.43 *Negative cycle detection.* Suppose that we add a constructor to ALGORITHM 4.11 that differs from the constructor given only in that it omits the second argument and that it initializes all `distTo[]` entries to 0. Show that, if a client uses that constructor, a client call to `hasNegativeCycle()` returns `true` if and only if the graph has a negative cycle (and `negativeCycle()` returns that cycle).

Answer: Consider a digraph formed from the original by adding a new source with an edge of weight 0 to all the other vertices. After one pass, all `distTo[]` entries are 0, and finding a negative cycle reachable from that source is the same as finding a negative cycle anywhere in the original graph.

4.4.44 *Worst case (Bellman-Ford).* Describe a family of graphs for which ALGORITHM 4.11 takes time proportional to VE .

4.4.45 *Fast Bellman-Ford.* Develop an algorithm that breaks the linearithmic running time barrier for the single-source shortest-paths problem in general edge-weighted digraphs for the special case where the weights are integers known to be bounded in absolute value by a constant.

4.4.46 *Animate.* Write a client program that does dynamic graphical animations of Dijkstra's algorithm.

EXPERIMENTS

4.4.47 *Random sparse edge-weighted digraphs.* Modify your solution to EXERCISE 4.3.34 to assign a random direction to each edge.

4.4.48 *Random Euclidean edge-weighted digraphs.* Modify your solution to EXERCISE 4.3.35 to assign a random direction to each edge.

4.4.49 *Random grid edge-weighted digraphs.* Modify your solution to EXERCISE 4.3.36 to assign a random direction to each edge.

4.4.50 *Negative weights I.* Modify your random edge-weighted digraph generators to generate weights between x and y (where x and y are both between -1 and 1) by rescaling.

4.4.51 *Negative weights II.* Modify your random edge-weighted digraph generators to generate negative weights by negating a fixed percentage (whose value is supplied by the client) of the edge weights.

4.4.52 *Negative weights III.* Develop client programs that use your edge-weighted digraph to produce edge-weighted digraphs that have a large percentage of negative weights but have at most a few negative cycles, for as large a range of values of V and E as possible.

Testing all algorithms and studying all parameters against all edge-weighted digraph models is unrealistic. For each problem listed below, write a client that addresses the problem for any given input digraph, then choose among the generators above to run experiments for that graph model. Use your judgment in selecting experiments, perhaps in response to results of previous experiments. Write a narrative explaining your results and any conclusions that might be drawn.

4.4.53 *Prediction.* Estimate, to within a factor of 10, the largest graph with $E = 10V$ that your computer and programming system could handle if you were to use Dijkstra's algorithm to compute all its shortest paths in 10 seconds.

4.4.54 *Cost of laziness.* Run empirical studies to compare the performance of the lazy version of Dijkstra's algorithm with the eager version, for various edge-weighted digraph models.

4.4.55 *Johnson's algorithm.* Develop a priority-queue implementation that uses a d -way heap. Find the best value of d for various edge-weighted digraph models.

4.4.56 *Arbitrage model.* Develop a model for generating random arbitrage problems. Your goal is to generate tables that are as similar as possible to the tables that you used in EXERCISE 4.4.20.

4.4.57 *Parallel job-scheduling-with-deadlines model.* Develop a model for generating random instances of the parallel job-scheduling-with-deadlines problem. Your goal is to generate nontrivial problems that are likely to be feasible.

FIVE



Strings

5.1	String Sorts	702
5.2	Tries	730
5.3	Substring Search	758
5.4	Regular Expressions	788
5.5	Data Compression	810

We communicate by exchanging strings of characters. Accordingly, numerous important and familiar applications are based on processing strings. In this chapter, we consider classic algorithms for addressing the underlying computational challenges surrounding applications such as the following:

Information processing. When you search for web pages containing a given keyword, you are using a string-processing application. In the modern world, virtually *all* information is encoded as a sequence of strings, and the applications that process it are string-processing applications of crucial importance.

Genomics. Computational biologists work with a *genetic code* that reduces DNA to (very long) strings formed from four characters (A, C, T, and G). Vast databases giving codes describing all manner of living organisms have been developed in recent years, so that string processing is a cornerstone of modern research in computational biology.

Communications systems. When you send a text message or an email or download an ebook, you are transmitting a string from one place to another. Applications that process strings for this purpose were an original motivation for the development of string-processing algorithms.

Programming systems. Programs are strings. Compilers, interpreters, and other applications that convert programs into machine instructions are critical applications that use sophisticated string-processing techniques. Indeed, all written languages are expressed as strings, and another motivation for the development of string-processing algorithms was the theory of formal languages, the study of describing sets of strings.

This list of a few significant examples illustrates the diversity and importance of string-processing algorithms.

The plan of this chapter is as follows: After addressing basic properties of strings, we revisit in SECTIONS 5.1 AND 5.2 the sorting and searching APIs from CHAPTERS 2 and 3. Algorithms that exploit special properties of string keys are faster and more flexible than the algorithms that we considered earlier. In SECTION 5.3 we consider algorithms for *substring search*, including a famous algorithm due to Knuth, Morris, and Pratt. In SECTION 5.4 we introduce *regular expressions*, the basis of the *pattern-matching* problem, a generalization of substring search, and a quintessential search tool known as *grep*. These classic algorithms are based on the related conceptual devices known as *formal languages* and *finite automata*. SECTION 5.5 is devoted to a central application: *data compression*, where we try to reduce the size of a string as much as possible.

Rules of the game For clarity and efficiency, our implementations are expressed in terms of the Java `String` class, but we intentionally use as few operations as possible from that class to make it easier to adapt our algorithms for use on other string-like types of data and to other programming languages. We introduced strings in detail in SECTION 1.2 but briefly review here their most important characteristics.

Characters. A `String` is a sequence of characters. Characters are of type `char` and can have one of 2^{16} possible values. For many decades, programmers restricted attention to characters encoded in 7-bit ASCII (see page 815 for a conversion table) or 8-bit extended ASCII, but many modern applications call for 16-bit Unicode.

Immutability. `String` objects are immutable, so that we can use them in assignment statements and as arguments and return values from methods without having to worry about their values changing.

Indexing. The operation that we perform most often is *extract a specified character from a string* that the `charAt()` method in Java's `String` class provides. We expect `charAt()` to complete its work in *constant* time, as if the string were stored in a `char[]` array. As discussed in CHAPTER 1, this expectation is quite reasonable.

Length. In Java, the *find the length of a string* operation is implemented in the `length()` method in `String`. Again, we expect `length()` to complete its work in *constant* time, and again, this expectation is reasonable, although some care is needed in some programming environments.

Substring. Java's `substring()` method implements the *extract a specified substring* operation. Again, we expect a *constant*-time implementation of this method, as in Java's standard implementation. *If you are not familiar with `substring()` and the reason that it is constant-time, be sure to reread our discussion of Java's standard string implementation in SECTION 1.2 (see page 80 and page 204).*

Concatenation. In Java, the *create a new string formed by appending one string to another* operation is a built-in operation (using the + operator) that takes time proportional to the length of the result. For example, we avoid forming a string by appending one character at a time because that is a *quadratic* process in Java. (Java has a `StringBuilder` class for that use.)

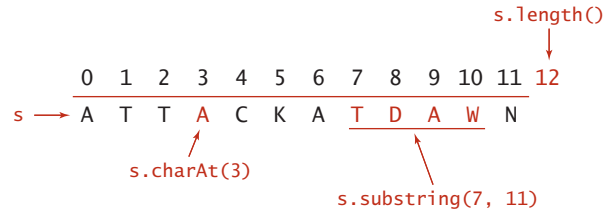

Fundamental constant-time String operations

Character arrays. The Java `String` is decidedly not a primitive type. The standard implementation provides the operations just described to facilitate client programming. By contrast, many of the algorithms that we consider can work with a low-level representation such as an array of `char` values, and many clients might prefer such a representation, because it consumes less space and takes less time. For several of the algorithms that we consider, the cost of converting from one representation to the other would be higher than the cost of running the algorithm. As indicated in the table below, the differences in code that processes the two representations are minor (`substring()` is more complicated and is omitted), so use of one representation or the other is no barrier to understanding the algorithm.

UNDERSTANDING THE EFFICIENCY OF THESE OPERATIONS is a key ingredient in understanding the efficiency of several string-processing algorithms. Not all programming languages provide `String` implementations with these performance characteristics. For example, the `substring` operation and determining the length of a string take time proportional to the number of characters in the string in the widely used C programming language. Adapting the algorithms that we describe to such languages is always possible (implement an ADT like Java's `String`), but also might present different challenges and opportunities.

operation	array of characters	Java string
<i>declare</i>	<code>char[] a</code>	<code>String s</code>
<i>indexed character access</i>	<code>a[i]</code>	<code>s.charAt(i)</code>
<i>length</i>	<code>a.length</code>	<code>s.length()</code>
<i>convert</i>	<code>a = s.toCharArray();</code>	<code>s = new String(a);</code>

Two ways to represent strings in Java

We primarily use the `String` data type in the text, with liberal use of indexing and length and occasional use of substring extraction and concatenation. When appropriate, we also provide on the booksite the corresponding code for `char` arrays. In performance-critical applications, the primary consideration in choosing between the two for clients is often the cost of accessing a character (`a[i]` is likely to be much faster than `s.charAt(i)` in typical Java implementations).

Alphabets Some applications involve strings taken from a restricted alphabet. In such applications, it often makes sense to use an `Alphabet` class with the following API:

```
public class Alphabet
```

<code>Alphabet(String s)</code>	<i>create a new alphabet from chars in s</i>
<code>char toChar(int index)</code>	<i>convert index to corresponding alphabet char</i>
<code>int toIndex(char c)</code>	<i>convert c to an index between 0 and R-1</i>
<code>boolean contains(char c)</code>	<i>is c in the alphabet?</i>
<code>int R()</code>	<i>radix (number of characters in alphabet)</i>
<code>int lgR()</code>	<i>number of bits to represent an index</i>
<code>int[] toIndices(String s)</code>	<i>convert s to base-R integer</i>
<code>String toChars(int[] indices)</code>	<i>convert base-R integer to string over this alphabet</i>

Alphabet API

This API is based on a constructor that takes as argument an R -character string that specifies the alphabet and the `toChar()` and `toIndex()` methods for converting (in constant time) between string characters and `int` values between 0 and $R-1$. It also includes a `contains()` method for checking whether a given character is in the alphabet, the methods `R()` and `lgR()` for finding the number of characters in the alphabet and the number of bits needed to represent them, and the methods `toIndices()` and `toChars()` for converting between strings of characters in the alphabet and `int` arrays. For convenience, we also include the built-in alphabets in the table at the top of the next page, which you can access with code such as `Alphabet.UNICODE`. Implementing `Alphabet` is a straightforward exercise (see EXERCISE 5.1.12). We will examine a sample client on page 699.

Character-indexed arrays. One of the most important reasons to use `Alphabet` is that many algorithms gain efficiency through the use of character-indexed arrays, where we associate information with each character that we can retrieve with a single array

name	R()	lgR()	characters
BINARY	2	1	01
DNA	4	2	ACTG
OCTAL	8	3	01234567
DECIMAL	10	4	0123456789
HEXADECIMAL	16	4	0123456789ABCDEF
PROTEIN	20	5	ACDEFGHIKLMNPQRSTUVWY
LOWERCASE	26	5	abcdefghijklmnopqrstvwxyz
UPPERCASE	26	5	ABCDEFGHIJKLMNQPQRSTUVWXYZ
BASE64	64	6	ABCDEFGHIJKLMNOPQRSTUVWXYZabcdefghijklmnopqrstuvwxyz0123456789+/ ghijklmnopqrstuvwxyz
ASCII	128	7	<i>ASCII characters</i>
EXTENDED_ASCII	256	8	<i>extended ASCII characters</i>
UNICODE16	65536	16	<i>Unicode characters</i>

Standard alphabets

```
public class Count
{
    public static void main(String[] args)
    {
        Alphabet alpha = new Alphabet(args[0]);
        int R = alpha.R();
        int[] count = new int[R];

        String s = StdIn.readAll();
        int N = s.length();
        for (int i = 0; i < N; i++)
            if (alpha.contains(s.charAt(i)))
                count[alpha.toIndex(s.charAt(i))]++;

        for (int c = 0; c < R; c++)
            StdOut.println(alpha.toChar(c)
                + " " + count[c]);
    }
}
```

```
% more abra.txt
ABRACADABRA!

% java Count ABCDR < abra.txt
A 5
B 2
C 1
D 1
R 2
```

Typical Alphabet client

access. With a Java `String`, we have to use an array of size 65,536; with `Alphabet`, we just need an array with one entry for each alphabet character. Some of the algorithms that we consider can produce huge numbers of such arrays, and in such cases, the space for arrays of size 65,536 can be prohibitive. As an example, consider the class `Count` at the bottom of the previous page, which takes a string of characters from the command line and prints a table of the frequency of occurrence of those characters that appear on standard input. The `count[]` array that holds the frequencies in `Count` is an example of a character-indexed array. This calculation may seem to you to be a bit frivolous; actually, it is the basis for a family of fast sorting methods that we will consider in SECTION 5.1.

Numbers. As you can see from several of the standard `Alphabet` examples, we often represent numbers as strings. The method `toIndices()` converts any `String` over a given `Alphabet` into a base- R number represented as an `int[]` array with all values between 0 and $R-1$. In some situations, doing this conversion at the start leads to compact code, because any digit can be used as an index in a character-indexed array. For example, if we know that the input consists only of characters from the alphabet, we could replace the inner loop in `Count` with the more compact code

```
int[] a = alpha.toIndices(s);
for (int i = 0; i < N; i++)
    count[a[i]]++;
```

In this context, we refer to R as the *radix*, the base of the number system. Several of the algorithms that we consider are often referred to as “radix” methods because they work with one digit at a time.

```
% more pi.txt
3141592653
5897932384
6264338327
9502884197
... [100,000 digits of pi]

% java Count 0123456789 < pi.txt
0 9999
1 10137
2 9908
3 10026
4 9971
5 10026
6 10028
7 10025
8 9978
9 9902
```

DESPITE THE ADVANTAGES of using a data type such as `Alphabet` in string-processing algorithms (particularly for small alphabets), we do not develop our implementations in the book for strings taken from a general `Alphabet` because

- The preponderance of clients just use `String`
- Conversion to and from indices tends to fall in the inner loop and slow down implementations considerably
- The code is more complicated, and therefore more difficult to understand

Accordingly we use `String`, use the constant $R = 256$ in the code and R as a parameter in the analysis, and discuss performance for general alphabets when appropriate. You can find full `Alphabet`-based implementations on the booksite.



5.1 STRING SORTS

FOR MANY SORTING APPLICATIONS, the keys that define the order are strings. In this section, we look at methods that take advantage of special properties of strings to develop sorts for string keys that are more efficient than the general-purpose sorts that we considered in CHAPTER 2.

We consider two fundamentally different approaches to string sorting. Both of them are venerable methods that have served programmers well for many decades.

The first approach examines the characters in the keys in a right-to-left order. Such methods are generally referred to as least-significant-digit (LSD) string sorts. Use of the term *digit* instead of *character* traces back to the application of the same basic method to numbers of various types. Thinking of a string as a base-256 number, considering characters from right to left amounts to considering first the least significant digits. This approach is the method of choice for string-sorting applications where all the keys are the same length.

The second approach examines the characters in the keys in a left-to-right order, working with the most significant character first. These methods are generally referred to as most-significant-digit (MSD) string sorts—we will consider two such methods in this section. MSD string sorts are attractive because they can get a sorting job done without necessarily examining all of the input characters. MSD string sorts are similar to quicksort, because they partition the array to be sorted into independent pieces such that the sort is completed by recursively applying the same method to the subarrays. The difference is that MSD string sorts use just the first character of the sort key to do the partitioning, while quicksort uses comparisons that could involve examining the whole key. The first method that we consider creates a partition for each character value; the second always creates three partitions, for sort keys whose first character is less than, equal to, or greater than the partitioning key's first character.

The number of characters in the alphabet is an important parameter when analyzing string sorts. Though we focus on extended ASCII strings ($R = 256$), we will also consider strings taken from much smaller alphabets (such as genomic sequences) and from much larger alphabets (such as the 65,536-character Unicode alphabet that is an international standard for encoding natural languages).

Key-indexed counting As a warmup, we consider a simple method for sorting that is effective whenever the keys are small integers. This method, known as *key-indexed counting*, is useful in its own right and is also the basis for two of the three string sorts that we consider in this section.

Consider the following data-processing problem, which might be faced by a teacher maintaining grades for a class with students assigned to sections, which are numbered 1, 2, 3, and so forth. On some occasions, it is necessary to have the class listed by section. Since the section numbers are small integers, sorting by key-indexed counting is appropriate. To describe the method, we assume that the information is kept in an array `a[]` of items that each contain a name and a section number, that section numbers are integers between 0 and `R-1`, and that

```
for (i = 0; i < N; i++)
    count[a[i].key() + 1]++;
```

		count[]
		0 1 2 3 4 5
		0 0 0 0 0 0
Anderson	2	0 0 0 1 0 0
Brown	3	0 0 0 1 1 0
Davis	3	0 0 0 1 2 0
Garcia	4	0 0 0 1 2 1
Harris	1	0 0 1 1 2 1
Jackson	3	0 0 1 1 3 1
Johnson	4	0 0 1 1 3 2
Jones	3	0 0 1 1 4 2
Martin	1	0 0 2 1 4 2
Martinez	2	0 0 2 2 4 2
Miller	2	0 0 2 3 4 2
Moore	1	0 0 3 3 4 2
Robinson	2	0 0 3 4 4 2
Smith	4	0 0 3 4 4 3
Taylor	3	0 0 3 4 5 3
Thomas	4	0 0 3 4 5 4
Thompson	4	0 0 3 4 5 5
White	2	0 0 3 5 5 5
Williams	3	0 0 3 5 6 5
Wilson	4	0 0 3 5 6 6

Computing frequency counts

the code `a[i].key()` returns the section number for the indicated student. The method breaks down into four steps, which we describe in turn.

Compute frequency counts. The first step is to count the frequency of occurrence of each key value, using an `int` array `count[]`. For each item, we use the key to access an entry in `count[]` and increment that entry. If the key value is `r`, we increment `count[r+1]`. (Why +1? The reason for that will become clear in the next step.) In the example at left, we first increment `count[3]` because Anderson is in section 2, then we increment `count[4]` twice because Brown and Davis are in section 3, and so forth. Note that `count[0]` is always 0, and that `count[1]` is 0 in this example (no students are in section 0).

input name	section	sorted result (by section)
Anderson	2	Harris 1
Brown	3	Martin 1
Davis	3	Moore 1
Garcia	4	Anderson 2
Harris	1	Martinez 2
Jackson	3	Miller 2
Johnson	4	Robinson 2
Jones	3	White 2
Martin	1	Brown 3
Martinez	2	Davis 3
Miller	2	Jackson 3
Moore	1	Jones 3
Robinson	2	Taylor 3
Smith	4	Williams 3
Taylor	3	Garcia 4
Thomas	4	Johnson 4
Thompson	4	Smith 4
White	2	Thomas 4
Williams	3	Thompson 4
Wilson	4	Wilson 4

Typical candidate for key-indexed counting

Transform counts to indices. Next, we use `count[]` to compute, for each key value, the starting index positions in the sorted order of items with that key. In our example, since there are three items with key 1 and five items with key 2, then the items with key 3 start at position 8 in the sorted array. In general, to get the starting index for items with any given key value we sum the frequency counts of smaller values. For each key value `r`, the sum of the counts for key values less than `r+1` is equal to the sum of the counts for key values less than `r` plus `count[r]`, so it is easy to proceed from left to right to transform `count[]` into an index table that we can use to sort the data.

```
for (int r = 0; r < R; r++)
    count[r+1] += count[r];
```

r	0	1	2	3	4	5
0	0	0	3	5	6	6
1	0	0	3	5	6	6
2	0	0	3	5	6	6
3	0	0	3	8	6	6
4	0	0	3	8	14	6
5	0	0	3	8	14	20
0	0	3	8	14	20	

always 0
number of keys less than 3
(start index of 3s in output)

Transforming counts to start indices

```
for (int i = 0; i < N; i++)
    aux[count[a[i].key()]++] = a[i];
```

i	1	2	3	4					
0	0	3	8	14					
1	0	4	8	14	a[0]	Anderson	2	Harris	1 aux[0]
2	0	4	9	14	a[1]	Brown	3	Martin	1 aux[1]
3	0	4	10	14	a[2]	Davis	3	Moore	1 aux[2]
4	0	4	10	15	a[3]	Garcia	4	Anderson	2 aux[3]
5	1	4	10	15	a[4]	Harris	1	Martinez	2 aux[4]
6	1	4	11	15	a[5]	Jackson	3	Miller	2 aux[5]
7	1	4	11	16	a[6]	Johnson	4	Robinson	2 aux[6]
8	1	4	12	16	a[7]	Jones	3	White	2 aux[7]
9	2	4	12	16	a[8]	Martin	1	Brown	3 aux[8]
10	2	5	12	16	a[9]	Martinez	2	Davis	3 aux[9]
11	2	6	12	16	a[10]	Miller	2	Jackson	3 aux[10]
12	3	6	12	16	a[11]	Moore	1	Jones	3 aux[11]
13	3	7	12	16	a[12]	Robinson	2	Taylor	3 aux[12]
14	3	7	12	17	a[13]	Smith	4	Williams	3 aux[13]
15	3	7	13	17	a[14]	Taylor	3	Garcia	4 aux[14]
16	3	7	13	18	a[15]	Thomas	4	Johnson	4 aux[15]
17	3	7	13	19	a[16]	Thompson	4	Smith	4 aux[16]
18	3	8	13	19	a[17]	White	2	Thomas	4 aux[17]
19	3	8	14	19	a[18]	Williams	3	Thompson	4 aux[18]
	3	8	14	20	a[19]	Wilson	4	Wilson	4 aux[19]
	3	8	14	20					

Distributing the data (records with key 3 highlighted)

Distribute the data. With the `count[]` array transformed into an index table, we accomplish the actual sort by moving the items to an auxiliary array `aux[]`. We move each item to the position in `aux[]` indicated by the `count[]` entry corresponding to its key, and then increment that entry to maintain the following invariant for `count[]`: for each key value `r`, `count[r]` is the index of the position in `aux[]` where the next item with key value `r` (if any) should be placed. This process produces a sorted result with one pass through the data, as illustrated at left. *Note:* In one of our applications, the fact that this implementation is *stable* is critical: items with equal keys are brought together but kept in the same relative order.

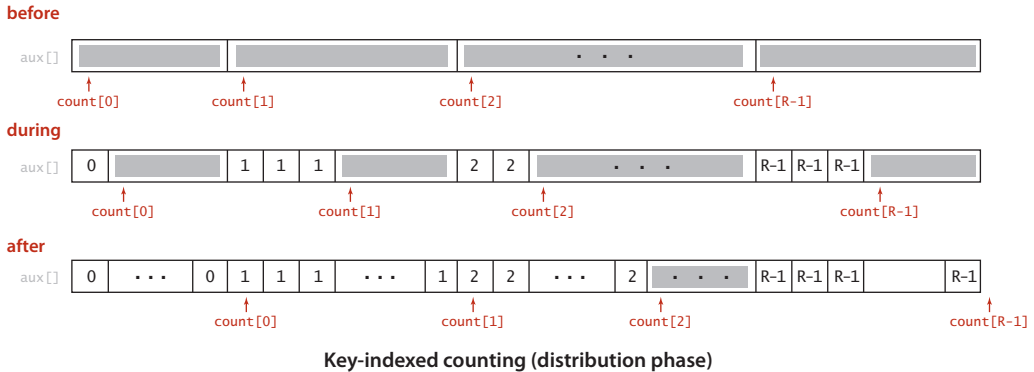

Copy back. Since we accomplished the sort by moving the items to an auxiliary array, the last step is to copy the sorted result back to the original array.

Proposition A. Key-indexed counting uses $8N + 3R + 1$ array accesses to stably sort N items whose keys are integers between 0 and $R - 1$.

Proof: Immediate from the code. Initializing the arrays uses $N + R + 1$ array accesses. The first loop increments a counter for each of the N items ($2N$ array accesses); the second loop does R additions ($2R$ array accesses); the third loop does N counter increments and N data moves ($3N$ array accesses); and the fourth loop does N data moves ($2N$ array accesses). Both moves preserve the relative order of equal keys.

KEY-INDEXED COUNTING is an extremely effective and often overlooked sorting method for applications where keys are small integers. Understanding how it works is a first step toward understanding string sorting. PROPOSITION A implies that key-indexed counting breaks through the $N \log N$ lower bound that we proved for sorting. How does it manage to do so? PROPOSITION I in SECTION 2.2 is a lower bound on the number of *compares* needed (when data is accessed only through `compareTo()`)—key-indexed counting does *no* compares (it accesses data only through `key()`). When R is within a constant factor of N , we have a linear-time sort.

```
int N = a.length;
String[] aux = new String[N];
int[] count = new int[R+1];

// Compute frequency counts.
for (int i = 0; i < N; i++)
    count[a[i].key() + 1]++;
// Transform counts to indices.
for (int r = 0; r < R; r++)
    count[r+1] += count[r];
// Distribute the records.
for (int i = 0; i < N; i++)
    aux[count[a[i].key()]++] = a[i];
// Copy back.
for (int i = 0; i < N; i++)
    a[i] = aux[i];
```

Key-indexed counting (`a[i].key` is an `int` in $[0, R)$).

LSD string sort The first string-sorting method that we consider is known as *least-significant-digit first* (LSD) string sort. Consider the following motivating application: Suppose that a highway engineer sets up a device that records the license plate numbers of all vehicles using a busy highway for a given period of time and wants to know the number of *different* vehicles that used the highway. As you know from SECTION 2.1, one easy way to solve this problem is to sort the numbers, then make a pass through to count the different values, as in *Dedup* (page 490). License plates are a mixture of numbers and letters, so it is natural to represent them as strings. In the simplest situation (such as the California license plate examples at right) the strings all have the same number of characters. This situation is often found in sort applications—for example, telephone numbers, bank account numbers, and IP addresses are typically fixed-length strings.

input	sorted result
4PGC938	1ICK750
2IYE230	1ICK750
3CIO720	10HV845
1ICK750	10HV845
10HV845	10HV845
4JZY524	2IYE230
1ICK750	2RLA629
3CIO720	2RLA629
10HV845	3ATW723
10HV845	3CIO720
2RLA629	3CIO720
2RLA629	4JZY524
3ATW723	4PGC938

↑
keys are all
the same length

Typical candidate for
LSD string sort

Sorting such strings can be done with key-indexed counting, as shown in ALGORITHM 5.1 (LSD) and the example below it on the facing page. If the strings are each of length W , we sort the strings W times with key-indexed counting, using each of the positions as the key, proceeding from right to left. It is not easy, at first, to be convinced that the method produces a sorted array—in fact, it does not work at all unless the key-indexed count implementation is stable. Keep this fact in mind and refer to the example when studying this proof of correctness:

Proposition B. LSD string sort stably sorts fixed-length strings.

Proof: This fact depends crucially on the key-indexed counting implementation being *stable*, as indicated in PROPOSITION A. After sorting keys on their i trailing characters (in a stable manner), we know that any two keys appear in proper order in the array (considering just those characters) either because the first of their i trailing characters is different, in which case the sort on that character puts them in order, or because the first of their i th trailing characters is the same, in which case they are in order because of stability (and by induction, for $i-1$).

Another way to state the proof is to think about the future: if the characters that have not been examined for a pair of keys are identical, any difference between the keys is restricted to the characters already examined, so the keys have been properly ordered and will remain so because of stability. If, on the other hand, the characters that have not

ALGORITHM 5.1 LSD string sort

```

public class LSD
{
    public static void sort(String[] a, int W)
    { // Sort a[] on leading W characters.
        int N = a.length;
        int R = 256;
        String[] aux = new String[N];

        for (int d = W-1; d >= 0; d--)
        { // Sort by key-indexed counting on dth char.

            int[] count = new int[R+1]; // Compute frequency counts.
            for (int i = 0; i < N; i++)
                count[a[i].charAt(d) + 1]++;

            for (int r = 0; r < R; r++) // Transform counts to indices.
                count[r+1] += count[r];

            for (int i = 0; i < N; i++) // Distribute.
                aux[count[a[i].charAt(d)]++] = a[i];

            for (int i = 0; i < N; i++) // Copy back.
                a[i] = aux[i];
        }
    }
}

```

To sort an array `a[]` of strings that each have exactly `W` characters, we do `W` key-indexed counting sorts: one for each character position, proceeding from right to left.

input ($W=7$)	$d=6$	$d=5$	$d=4$	$d=3$	$d=2$	$d=1$	$d=0$	output
4PGC938	2IYE230	3CI0720	2IYE230	2RLA629	1ICK750	3ATW723	1ICK750	1ICK750
2IYE230	3CI0720	3CI0720	4JZY524	2RLA629	1ICK750	3CI0720	1ICK750	1ICK750
3CI0720	1ICK750	3ATW723	2RLA629	4PGC938	4PGC938	3CI0720	10HV845	10HV845
1ICK750	1ICK750	4JZY524	2RLA629	2IYE230	10HV845	1ICK750	10HV845	10HV845
10HV845	3CI0720	2RLA629	3CI0720	1ICK750	10HV845	1ICK750	10HV845	10HV845
4JZY524	3ATW723	2RLA629	3CI0720	1ICK750	10HV845	2IYE230	2IYE230	2IYE230
1ICK750	4JZY524	2IYE230	3ATW723	3CI0720	3CI0720	4JZY524	2RLA629	2RLA629
3CI0720	10HV845	4PGC938	1ICK750	3CI0720	3CI0720	10HV845	2RLA629	2RLA629
10HV845	10HV845	10HV845	1ICK750	10HV845	2RLA629	10HV845	3ATW723	3ATW723
10HV845	10HV845	10HV845	10HV845	10HV845	2RLA629	10HV845	3CI0720	3CI0720
2RLA629	4PGC938	10HV845	10HV845	10HV845	3ATW723	4PGC938	3CI0720	3CI0720
2RLA629	2RLA629	1ICK750	10HV845	3ATW723	2IYE230	2RLA629	4JZY524	4JZY524
3ATW723	2RLA629	1ICK750	4PGC938	4JZY524	4JZY524	2RLA629	4PGC938	4PGC938

♣ J	♦ A	♠ A
♥ 6	♥ A	♠ 2
♦ A	♣ A	♠ 3
♥ A	♠ A	♠ 4
♠ K	♠ 2	♠ 5
♥ J	♥ 2	♠ 6
♦ Q	♥ 2	♠ 7
♣ 6	♦ 2	♠ 8
♠ J	♥ 3	♠ 9
♣ A	♠ 3	♠ 10
♦ 9	♠ 3	♠ J
♥ 9	♦ 3	♠ Q
♦ 8	♦ 4	♠ K
♠ 9	♣ 4	♥ A
♣ K	♥ 4	♥ 2
♦ 4	♠ 4	♥ 3
♠ 5	♠ 5	♥ 4
♠ Q	♦ 5	♥ 5
♥ 3	♣ 5	♥ 6
♠ 2	♥ 5	♥ 7
♣ 10	♥ 6	♥ 8
♠ 9	♠ 6	♥ 9
♥ 7	♠ 6	♥ 10
♣ 4	♦ 6	♥ J
♥ 4	♥ 7	♥ Q
♦ 10	♠ 7	♥ K
♠ A	♠ 7	♦ A
♦ 5	♦ 7	♦ 2
♠ 3	♦ 8	♦ 3
♥ 8	♥ 8	♦ 4
♣ 2	♠ 8	♦ 5
♦ K	♠ 8	♦ 6
♠ 4	♦ 9	♦ 7
♠ 7	♥ 9	♦ 8
♥ Q	♠ 9	♦ 9
♦ J	♠ 9	♦ 10
♠ 6	♠ 10	♦ J
♣ 3	♦ 10	♦ Q
♠ 7	♠ 10	♦ K
♠ 8	♥ 10	♠ A
♠ 10	♠ J	♠ 2
♦ 3	♥ J	♠ 3
♥ 10	♠ J	♠ 4
♦ 7	♦ J	♠ 5
♠ Q	♦ Q	♠ 6
♥ 2	♠ Q	♠ 7
♦ 2	♥ Q	♠ 8
♣ 5	♠ Q	♠ 9
♥ K	♠ K	♠ 10
♥ 5	♠ K	♠ J
♦ 6	♦ K	♠ Q
♣ 8	♥ K	♠ K

Sorting a card deck with
LSD string sort

been examined are different, the characters already examined do not matter, and a later pass will correctly order the pair based on the more significant differences.

LSD radix sorting is the method used by the old punched-card-sorting machines that were developed at the beginning of the 20th century and thus predated the use of computers in commercial data processing by several decades. Such machines had the capability of distributing a deck of punched cards among 10 bins, according to the pattern of holes punched in the selected columns. If a deck of cards had numbers punched in a particular set of columns, an operator could sort the cards by running them through the machine on the rightmost digit, then picking up and stacking the output decks in order, then running them through the machine on the next-to-rightmost digit, and so forth, until getting to the first digit. The physical stacking of the cards is a stable process, which is mimicked by key-indexed counting sort. Not only was this version of LSD radix sorting important in commercial applications up through the 1970s, but it was also used by many cautious programmers (and students!), who would have to keep their programs on punched cards (one line per card) and would punch sequence numbers in the final few columns of a program deck so as to be able to put the deck back in order mechanically if it were accidentally dropped. This method is also a neat way to sort a deck of playing cards: deal them into thirteen piles (one for each value), pick up the piles in order, then deal into four piles (one for each suit). The (stable) dealing process keeps the cards in order within each suit, so picking up the piles in suit order yields a sorted deck.

In many string-sorting applications (even license plates, for some states), the keys are not all be the same length. It is possible to adapt LSD string sort to work for such applications, but we leave this task for exercises because we will next consider two other methods that are specifically designed for variable-length keys.

From a theoretical standpoint, LSD string sort is significant because it is a *linear*-time sort for typical applications. No matter how large the value of N , it makes W passes through the data. Specifically:

Proposition B (continued). LSD string sort uses $\sim 7WN + 3WR$ array accesses and extra space proportional to $N + R$ to sort N items whose keys are W -character strings taken from an R -character alphabet.

Proof: The method is W passes of key-indexed counting, except that the `aux[]` array is initialized just once. The total is immediate from the code and PROPOSITION A.

For typical applications, R is far smaller than N , so PROPOSITION B implies that the total running time is proportional to WN . An input array of N strings that each have W characters has a total of WN characters, so the running time of LSD string sort is *linear* in the size of the input.

♣ J	♠ K	♠ A
♥ 6	♠ J	♠ 2
♦ A	♠ 9	♠ 3
♥ A	♠ 5	♠ 4
♠ K	♠ 2	♠ 5
♥ J	♠ A	♠ 6
♦ Q	♠ 3	♠ 7
♣ 6	♠ 4	♠ 8
♠ J	♠ 6	♠ 9
♣ A	♠ 7	♠ 10
♦ 9	♠ 8	♠ J
♥ 9	♠ 10	♠ Q
♦ 8	♠ Q	♠ K
♠ 9	♥ 6	♥ A
♣ K	♥ A	♥ 2
♦ 4	♥ J	♥ 3
♠ 5	♥ 9	♥ 4
♣ Q	♥ 3	♥ 5
♥ 3	♥ 7	♥ 6
♠ 2	♥ 4	♥ 7
♠ 10	♥ 8	♥ 8
♣ 9	♥ Q	♥ 9
♥ 7	♥ 10	♥ 10
♣ 4	♥ 2	♥ J
♥ 4	♥ K	♥ Q
♦ 10	♥ 5	♥ K
♠ A	♦ A	♦ A
♦ 5	♦ Q	♦ 2
♠ 3	♦ 9	♦ 3
♥ 8	♦ 8	♦ 4
♣ 2	♦ 4	♦ 5
♦ K	♦ 10	♦ 6
♠ 4	♦ 5	♦ 7
♣ 7	♦ K	♦ 8
♥ Q	♦ J	♦ 9
♠ J	♦ 3	♦ 10
♠ 6	♦ 7	♦ J
♣ 3	♦ 2	♦ Q
♠ 7	♦ 6	♦ K
♠ 8	♣ J	♣ A
♠ 10	♣ 6	♣ 2
♦ 3	♣ A	♣ 3
♥ 10	♣ K	♣ 4
♦ 7	♣ Q	♣ 5
♠ Q	♣ 10	♣ 6
♥ 2	♣ 9	♣ 7
♦ 2	♣ 4	♣ 8
♠ 5	♣ 2	♣ 9
♥ K	♣ 7	♣ 10
♥ 5	♣ 3	♣ J
♦ 6	♣ 5	♣ Q
♠ 8	♣ 8	♣ K

Sorting a card deck with MSD string sort

MSD string sort To implement a general-purpose string sort, where strings are not necessarily all the same length, we consider the characters in left-to-right order. We know that strings that start with a should appear before strings that start with b, and so forth. The natural way to implement this idea is a recursive method known as *most-significant-digit-first* (MSD) string sort. We use key-indexed counting to sort the strings according to their first character, then (recursively) sort the subarrays corresponding to each character (excluding the first character, which we know to be the same for each string in each subarray). Like quicksort, MSD string sort partitions the array into subarrays that can be sorted independently to complete the job, but it partitions the array into one subarray for each possible value of the first character, instead of the two or three partitions in quicksort.

End-of-string convention. We need to pay particular attention to reaching the ends of strings in MSD string sort. For a proper sort, we need the subarray for strings whose characters have all been examined to appear as the first subarray, and we do not want to recursively sort this subarray. To facilitate these two parts of the computation we use a private two-argument `toChar()` method to convert from an indexed string character to an array index that returns `-1` if the specified character position is past the end of the string. Then, we just add 1 to each returned value, to get a nonnegative `int` that we can use to index `count[]`. This convention means that we have `R+1` different possible character values at each string position: 0 to signify *end of string*, 1 for the first alphabet character, 2 for the second alphabet character, and so forth. Since

sort on first character value to partition into subarrays *recursively sort subarrays (excluding first character)*



Overview of MSD string sort

key-indexed counting already needs one extra position, we use the code `int count[] = new int[R+2];` to create the array of frequency counts (and set all of its values to 0). *Note*: Some languages, notably C and C++, have a built-in end-of-string convention, so our code needs to be adjusted accordingly for such languages.

WITH THESE PREPARATIONS, the implementation of MSD string sort, in ALGORITHM 5.2, requires very little new code. We add a test to cutoff to insertion sort for small subarrays (using a specialized insertion sort that we will consider later), and we add a loop to key-indexed counting to do the recursive calls. As summarized in the table at the bottom of this page, the values in the `count[]` array (after serving to count the frequencies, transform counts to indices, and distribute the data) give us precisely the information that we need to (recursively) sort the subarrays corresponding to each character value.

Specified alphabet. The cost of MSD string sort depends strongly on the number of possible characters in the alphabet. It is easy to modify our sort method to take an `Alphabet` as argument, to allow for improved efficiency in clients involving strings taken from relatively small alphabets. The following changes will do the job:

- Save the alphabet in an instance variable `alpha` in the constructor.
- Set `R` to `alpha.R()` in the constructor.
- Replace `s.charAt(d)` with `alpha.toIndex(s.charAt(d))` in `charAt()`.

input	sorted result
she	are
se11s	by
seashells	seashells
by	seashells
the	seashore
seashore	sells
the	sells
se11s	she
she	she
se11s	se11s
are	surely
surely	the
seashells	the

various key lengths

Typical candidate for MSD string sort

at completion of phase for dth character	value of count[r] is				
	r = 0	r = 1	r between 2 and R-1	r = R	r = R+1
count frequencies	0 (not used)	number of strings of length d	number of strings whose dth character value is r-2		
transform counts to indices	start index of subarray for strings of length d	start index of subarray for strings whose dth character value is r-1			not used
distribute	start index of subarray for strings whose dth character value is r			not used	
	1 + end index of subarray for strings of length d	1 + end index of subarray for strings whose dth character value is r-1			not used

Interpretation of `count[]` values during MSD string sort

ALGORITHM 5.2 MSD string sort

```

public class MSD
{
    private static int R = 256;           // radix
    private static final int M = 15;     // cutoff for small subarrays
    private static String[] aux;        // auxiliary array for distribution

    private static int charAt(String s, int d)
    { if (d < s.length()) return s.charAt(d); else return -1; }

    public static void sort(String[] a)
    {
        int N = a.length;
        aux = new String[N];
        sort(a, 0, N-1, 0);
    }

    private static void sort(String[] a, int lo, int hi, int d)
    { // Sort from a[lo] to a[hi], starting at the dth character.

        if (hi <= lo + M)
            { Insertion.sort(a, lo, hi, d); return; }

        int[] count = new int[R+2];      // Compute frequency counts.
        for (int i = lo; i <= hi; i++)
            count[charAt(a[i], d) + 2]++;

        for (int r = 0; r < R+1; r++)    // Transform counts to indices.
            count[r+1] += count[r];

        for (int i = lo; i <= hi; i++)  // Distribute.
            aux[count[charAt(a[i], d) + 1]++] = a[i];

        for (int i = lo; i <= hi; i++)  // Copy back.
            a[i] = aux[i - lo];

        // Recursively sort for each character value.
        for (int r = 0; r < R; r++)
            sort(a, lo + count[r], lo + count[r+1] - 1, d+1);
    }
}

```

To sort an array `a[]` of strings, we sort them on their first character using key-indexed counting, then (recursively) sort the subarrays corresponding to each first-character value.

In our running examples, we use strings made up of lowercase letters. It is also easy to extend LSD string sort to provide this feature, but typically with much less impact on performance than for MSD string sort.

THE CODE IN ALGORITHM 5.2 is deceptively simple, masking a rather sophisticated computation. It is definitely worth your while to study the trace of the top level at the bottom of this page and the trace of recursive calls on the next page, to be sure that you understand the intricacies of the algorithm. This trace uses a cutoff-for-small-subarrays threshold value (M) of 0, so that you can see the sort to completion for this small example. The strings in this example are taken from `Alphabet.LOWERCASE`, with $R = 26$; bear in mind that typical applications might use `Alphabet.EXTENDED.ASCII`, with $R = 256$, or `Alphabet.UNICODE`, with $R = 65536$. For large alphabets, MSD string sort is so simple as to be dangerous—improperly used, it can consume outrageous amounts of time and space. Before considering performance characteristics in detail, we shall discuss three important issues (all of which we have considered before, in CHAPTER 2) that must be addressed in any application.

Small subarrays. The basic idea behind MSD string sort is quite effective: in typical applications, the strings will be in order after examining only a few characters in the key. Put another way, the method quickly divides the array to be sorted into small

	use key-indexed counting on first character				recursively sort subarrays	
	count frequencies	transform counts to indices	distribute and copy back	indices at completion of distribute phase		
0	she	0 a 0	0 are	0 0 0	sort(a, 0, 0, 1);	0 are
1	sells	2 b 1	1 by	1 a 1	sort(a, 1, 1, 1);	1 by
2	seashells	3 c 1	2 she	2 b 2	sort(a, 2, 1, 1);	2 sea
3	by	4 d 0	3 sells	3 c 2	sort(a, 2, 1, 1);	3 seashells
4	the	5 e 0	4 seashells	4 d 2	sort(a, 2, 1, 1);	4 seashells
5	sea	6 f 0	5 sea	5 e 2	sort(a, 2, 1, 1);	5 sells
6	shore	7 g 0	6 shore	6 f 2	sort(a, 2, 1, 1);	6 sells
7	the	8 h 0	7 shells	7 g 2	sort(a, 2, 1, 1);	7 she
8	shells	9 i 0	8 she	8 h 2	sort(a, 2, 1, 1);	8 she
9	she	10 j 0	9 sells	9 i 2	sort(a, 2, 1, 1);	9 shells
10	sells	11 k 0	10 surely	10 j 2	sort(a, 2, 1, 1);	10 shore
11	are	12 l 0	11 seashells	11 k 2	sort(a, 2, 1, 1);	11 surely
12	surely	13 m 0	12 the	12 l 2	sort(a, 2, 11, 1);	12 the
13	seashells	14 n 0	13 the	13 m 2	sort(a, 12, 13, 1);	13 the
		15 o 0		14 n 2	sort(a, 14, 13, 1);	
		16 p 0		15 o 2	sort(a, 14, 13, 1);	
		17 q 0		16 p 2	sort(a, 2, 1, 1);	
		18 r 0		17 q 2	sort(a, 14, 13, 1);	
		19 s 0		18 r 2	sort(a, 14, 13, 1);	
		20 t 10		19 s 12	sort(a, 14, 13, 1);	
		21 u 2		20 t 14	sort(a, 14, 13, 1);	
		22 v 0		21 u 14	sort(a, 14, 13, 1);	
		23 w 0		22 v 14	sort(a, 14, 13, 1);	
		24 x 0		23 w 14	sort(a, 14, 13, 1);	
		25 y 0		24 x 14	sort(a, 14, 13, 1);	
		26 z 0		25 y 14	sort(a, 14, 13, 1);	
		27 0		26 z 14	sort(a, 14, 13, 1);	
				27 14	sort(a, 14, 13, 1);	

Trace of MSD string sort: top level of sort(a, 0, 14, 0)

input

she	are	are	are	are	are	are	are	are	are
sells	by	by	by	by	by	by	by	by	by
seashells	she	sells	seashells	sea	sea	sea	seas	sea	
by	sells	seashells	sea	seashells	seashells	seashells	seashells	seashells	
the	seashells	sea	seashells	seashells	seashells	seashells	seashells	seashells	
sea	sea	sells	sells	sells	sells	sells	sells	sells	
shore	shore	seashells	sells	sells	sells	sells	sells	sells	
the	shells	she	she	she	she	she	she	she	
shells	she	shore	shore	shore	shore	shore	shells	shells	
she	sells	shells	shells	shells	shells	shells	shore	shore	
sells	surely	she	she	she	she	she	she	she	
are	seashells	surely	surely	surely	surely	surely	surely	surely	
surely	the	the	the	the	the	the	the	the	
seashells	the	the	the	the	the	the	the	the	

are	are	are	are	are	are	are	are	output
by	by	by	by	by	by	by	by	are
sea	sea	sea	sea	sea	sea	sea	sea	by
seashells	seashells	seashells	seashells	seashells	seashells	seashells	seashells	sea
seashells	seashells	seashells	seashells	seashells	seashells	seashells	seashells	seashells
sells	sells	sells	sells	sells	sells	sells	sells	sells
sells	sells	sells	sells	sells	sells	sells	sells	sells
she	she	she	she	she	she	she	she	she
shells	shells	shells	shells	she	she	she	she	she
she	she	she	she	shells	shells	shells	shells	shells
shore	shore	shore	shore	shore	shore	shore	shore	shore
surely	surely	surely	surely	surely	surely	surely	surely	surely
the	the	the	the	the	the	the	the	the
the	the	the	the	the	the	the	the	the

Trace of recursive calls for MSD string sort (no cutoff for small subarrays, subarrays of size 0 and 1 omitted)

subarrays. But this is a double-edged sword: we are certain to have to handle huge numbers of tiny subarrays, so we had better be sure that we handle them efficiently. *Small subarrays are of critical importance in the performance of MSD string sort.* We have seen this situation for other recursive sorts (quicksort and mergesort), but it is much more dramatic for MSD string sort. For example, suppose that you are sorting millions of ASCII strings ($R = 256$) that are all different, with no cutoff for small subarrays. Each string eventually finds its way to its own subarray, so you will sort millions of subarrays of size 1. But each such sort involves initializing the 258 entries of the `count[]` array to 0 and transforming them all to indices. This cost is likely to dominate the rest of the sort. With Unicode ($R = 65536$) the sort might be *thousands* of times slower. Indeed, many unsuspecting sort clients have seen their running times explode from minutes to

```

public static void sort(String[] a, int lo, int hi, int d)
{ // Sort from a[lo] to a[hi], starting at the dth character.
    for (int i = lo; i <= hi; i++)
        for (int j = i; j > lo && less(a[j], a[j-1], d); j--)
            exch(a, j, j-1);
}

private static boolean less(String v, String w, int d)
{ return v.substring(d).compareTo(w.substring(d)) < 0; }

```

Insertion sort for strings whose first *d* characters are equal

hours on switching from ASCII to Unicode, for precisely this reason. Accordingly, the switch to insertion sort for small subarrays is a *must* for MSD string sort. To avoid the cost of reexamining characters that we know to be equal, we use the version of insertion sort given at the top of the page, which takes an extra argument *d* and assumes that the first *d* characters of all the strings to be sorted are known to be equal. The efficiency of this code depends on `substring()` being a constant-time operation. As with quicksort and mergesort, most of the benefit of this improvement is achieved with a small value of the cutoff, but the savings here are much more dramatic. The diagram at right shows the results of experiments where using a cutoff to insertion sort for subarrays of size 10 or less decreases the running time by a factor of 10 for a typical application.

Equal keys. A second pitfall for MSD string sort is that it can be relatively slow for subarrays containing large numbers of equal keys. If a substring occurs sufficiently often that the cutoff for small subarrays does not apply, then a recursive call is needed for every character in all of the equal keys. Moreover, key-indexed counting is an inefficient way to determine that the characters are all equal: not only does each character need to be examined and each string moved, but all the counts have to be initialized, converted to indices, and so forth. Thus, the worst case for MSD string sorting is when all keys are equal. The same problem arises when large numbers of keys have long common prefixes, a situation often found in applications.

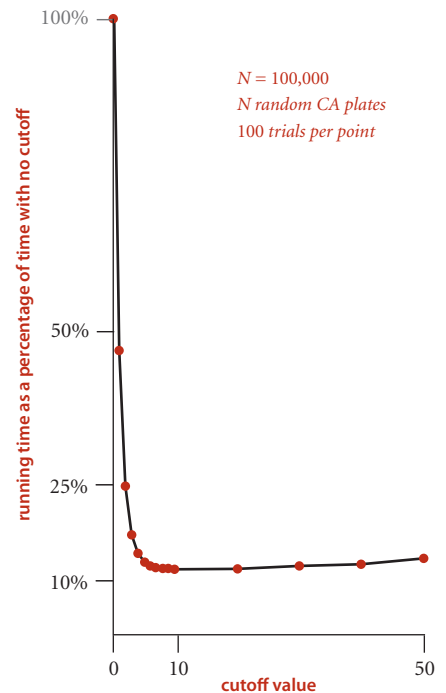

Effect of cutoff for small subarrays in MSD string sort

Extra space. To do the partitioning, MSD uses two auxiliary arrays: the temporary array for distributing keys (`aux[]`) and the array that holds the counts that are transformed into partition indices (`count[]`). The `aux[]` array is of size N and can be created outside the recursive `sort()` method. This extra space can be eliminated by sacrificing stability (see EXERCISE 5.1.17), but it is often not a major concern in practical applications of MSD string sort. Space for the `count[]` array, on the other hand, can be an important issue (because it *cannot* be created outside the recursive `sort()` method) as addressed in PROPOSITION D below.

Random string model. To study the performance of MSD string sort, we use a *random string model*, where each string consists of (independently) random characters, with no bound on their length. Long equal keys are essentially ignored, because they are extremely unlikely. The behavior of MSD string sort in this model is similar to its behavior in a model where we consider random fixed-length keys and also to its performance for typical real data; in all three, MSD string sort tends to examine just a few characters at the beginning of each key, as we will see.

Performance. The running time of MSD string sort depends on the data. For compare-based methods, we were primarily concerned with the *order* of the keys; for MSD string sort, the order of the keys is immaterial, but we are concerned with the *values* of the keys.

random (sublinear)	nonrandom with duplicates (nearly linear)	worst case (linear)
1EI0402	are	1DNB377
1HYL490	by	1DNB377
1R0Z572	sea	1DNB377
2HXE734	seashells	1DNB377
2IYE230	seashells	1DNB377
2X0R846	sells	1DNB377
3CDB573	sells	1DNB377
3CVP720	she	1DNB377
3IGJ319	she	1DNB377
3KNA382	shells	1DNB377
3TAV879	shore	1DNB377
4CQP781	surely	1DNB377
4QGI284	the	1DNB377
4YHV229	the	1DNB377

Characters examined by MSD string sort

- For *random* inputs, MSD string sort examines just enough characters to distinguish among the keys, and the running time is *sublinear* in the number of characters in the data (it examines a small fraction of the input characters).
- For *nonrandom* inputs, MSD string sort still could be sublinear but might need to examine more characters than in the random case, depending on the data. In particular, it has to examine all the characters in equal keys, so the running time is nearly linear in the number of characters in the data when significant numbers of equal keys are present.
- In the *worst* case, MSD string sort examines all the characters in the keys, so the running time is *linear* in the number of characters in the data (like LSD string sort). A worst-case input is one with all strings equal.

Some applications involve distinct keys that are well-modeled by the random string model; others have significant numbers of equal keys or long common prefixes, so the sort time is closer to the worst case. Our license-plate-processing application, for example, can fall anywhere between these extremes: if our engineer takes an hour of data from a busy interstate, there will not be many duplicates and the random model will apply; for a week's worth of data on a local road, there will be numerous duplicates and performance will be closer to the worst case.

Proposition C. To sort N random strings from an R -character alphabet, MSD string sort examines about $N \log_R N$ characters, on average.

Proof sketch: We expect the subarrays to be all about the same size, so the recurrence $C_N = RC_{N/R} + N$ approximately describes the performance, which leads to the stated result, generalizing our argument for quicksort in CHAPTER 2. Again, this description of the situation is not entirely accurate, because N/R is not necessarily an integer, and the subarrays are the same size only on the average (and because the number of characters in real keys is finite). These effects turn out to be less significant for MSD string sort than for standard quicksort, so the leading term of the running time is the solution to this recurrence. The detailed analysis that proves this fact is a classical example in the analysis of algorithms, first done by Knuth in the early 1970s.

As food for thought and to indicate why the proof is beyond the scope of this book, note that key length does not play a role. Indeed, the random-string model allows key length to approach infinity. There is a nonzero probability that two keys will match for any specified number of characters, but this probability is so small as to not play a role in our performance estimates.

As we have discussed, the number of characters examined is not the full story for MSD string sort. We also have to take into account the time and space required to count frequencies and turn the counts into indices.

Proposition D. MSD string sort uses between $8N + 3R$ and $\sim 7wN + 3WR$ array accesses to sort N strings taken from an R -character alphabet, where w is the average string length.

Proof: Immediate from the code, PROPOSITION A, and PROPOSITION B. In the best case MSD sort uses just one pass; in the worst case, it performs like LSD string sort.

When N is small, the factor of R dominates. Though precise analysis of the total cost becomes difficult and complicated, you can estimate the effect of this cost just by considering small subarrays when keys are distinct. With no cutoff for small subarrays, each key appears in its own subarray, so NR array accesses are needed for just these subarrays. If we cut off to small subarrays of size M , we have about N/M subarrays of size M , so we are trading off NR/M array accesses with $NM/4$ compares, which tells us that we should choose M to be proportional to the square root of R .

Proposition D (continued). To sort N strings taken from an R -character alphabet, the amount of space needed by MSD string sort is proportional to R times the length of the longest string (plus N), in the worst case.

Proof: The `count[]` array must be created within `sort()`, so the total amount of space needed is proportional to R times the depth of recursion (plus N for the auxiliary array). Precisely, the depth of the recursion is the length of the longest string that is a prefix of two or more of the strings to be sorted.

As just discussed, equal keys cause the depth of the recursion to be proportional to the length of the keys. The immediate practical lesson to be drawn from PROPOSITION D is that it is quite possible for MSD string sort to run out of time or space when sorting long strings taken from large alphabets, particularly if long equal keys are to be expected. For example, with `Alphabet.UNICODE` and more than M equal 1,000-character strings, `MSD.sort()` would require space for over 65 million counters!

THE MAIN CHALLENGE in getting maximum efficiency from MSD string sort on keys that are long strings is to deal with lack of randomness in the data. Typically, keys may have long stretches of equal data, or parts of them might fall in only a narrow range. For example, an information-processing application for student data might have keys that include graduation year (4 bytes, but one of four different values), state names (perhaps 10 bytes, but one of 50 different values), and gender (1 byte with one of two given values), as well as a person's name (more similar to random strings, but probably not short, with nonuniform letter distributions, and with trailing blanks in a fixed-length field). Restrictions like these lead to large numbers of empty subarrays during the MSD string sort. Next, we consider a graceful way to adapt to such situations.

Three-way string quicksort We can also adapt quicksort to MSD string sorting by using 3-way partitioning on the leading character of the keys, moving to the next character on only the middle subarray (keys with leading character equal to the partitioning character). This method is not difficult to implement, as you can see in ALGORITHM 5.3: we just add an argument to the recursive method in ALGORITHM 2.5 that keeps track of the current character, adapt the 3-way partitioning code to use that character, and appropriately modify the recursive calls.

Although it does the computation in a different order, 3-way string quicksort amounts to sorting the array on the leading characters of the keys (using quicksort), then applying the method recursively on the remainder of the keys. For sorting strings, the method compares favorably with normal quicksort and with MSD string sort. Indeed, it is a hybrid of these two algorithms.

Three-way string quicksort divides the array into only three parts, so it involves more data movement than MSD string sort when the number of nonempty partitions is large because it has to

input	sorted result
edu.princeton.cs	com.adobe
com.apple	com.apple
edu.princeton.cs	com.cnn
com.cnn	com.google
com.google	edu.princeton.cs
edu.uva.cs	edu.princeton.cs
edu.princeton.cs	edu.princeton.cs
edu.princeton.cs.www	edu.princeton.cs.www
edu.uva.cs	edu.princeton.ee
edu.uva.cs	edu.uva.cs
edu.uva.cs	edu.uva.cs
com.adobe	edu.uva.cs
edu.princeton.ee	edu.uva.cs

long prefix match (arrow pointing to the 'edu.princeton.cs' entries)

duplicate keys (arrow pointing to the 'edu.uva.cs' entries)

Typical 3-way string quicksort candidate

use first character value to partition into "less," "equal," and "greater" subarrays

recursively sort subarrays (excluding first character for "equal" subarray)



Overview of 3-way string quicksort

do a series of 3-way partitions to get the effect of the multiway partition. On the other hand, MSD string sort can create large numbers of (empty) subarrays, whereas 3-way string quicksort always has just three. Thus, 3-way string quicksort adapts well to handling equal keys, keys with long common prefixes, keys that fall into a small range, and small arrays—all situations where MSD string sort runs slowly. Of particular importance is that the

ALGORITHM 5.3 Three-way string quicksort

```
public class Quick3string
{
    private static int charAt(String s, int d)
    { if (d < s.length()) return s.charAt(d); else return -1; }

    public static void sort(String[] a)
    { sort(a, 0, a.length - 1, 0); }

    private static void sort(String[] a, int lo, int hi, int d)
    {
        if (hi <= lo) return;

        int lt = lo, gt = hi;
        int v = charAt(a[lo], d);
        int i = lo + 1;
        while (i <= gt)
        {
            int t = charAt(a[i], d);
            if (t < v)  exch(a, lt++, i++);
            else if (t > v) exch(a, i, gt--);
            else      i++;
        }

        // a[lo..lt-1] < v = a[lt..gt] < a[gt+1..hi]

        sort(a, lo, lt-1, d);
        if (v >= 0) sort(a, lt, gt, d+1);
        sort(a, gt+1, hi, d);
    }
}
```

To sort an array `a[]` of strings, we 3-way partition them on their first character, then (recursively) sort the three resulting subarrays: the strings whose first character is less than the partitioning character, the strings whose first character is equal to the partitioning character (excluding their first character in the sort), and the strings whose first character is greater than the partitioning character.

partitioning adapts to different kinds of structure in different parts of the key. Also, like quicksort, 3-way string quicksort does not use extra space (other than the implicit stack to support recursion), which is an important advantage over MSD string sort, which requires space for both frequency counts and an auxiliary array.

The figure at the bottom of this page shows all of the recursive calls that `Quick3string` makes for our example. Each subarray is sorted using precisely three recursive calls, except when we skip the recursive call on reaching the ends of the (equal) string(s) in the middle subarray.

As usual, in practice, it is worthwhile to consider various standard improvements to the implementation in ALGORITHM 5.3:

Small subarrays. In any recursive algorithm, we can gain efficiency by treating small subarrays differently. In this case, we use the insertion sort from page 715, which skips the characters that are known to be equal. The improvement due to this change is likely to be significant, though not nearly as important as for MSD string sort.

Restricted alphabet. To handle specialized alphabets, we could add an `Alphabet` argument `alpha` to each of the methods and replace `s.charAt(d)` with `alpha.toIndex(s.charAt(d))` in `charAt()`. In this case, there is no benefit to doing so, and adding this code is likely to substantially slow the algorithm down because this code is in the inner loop.

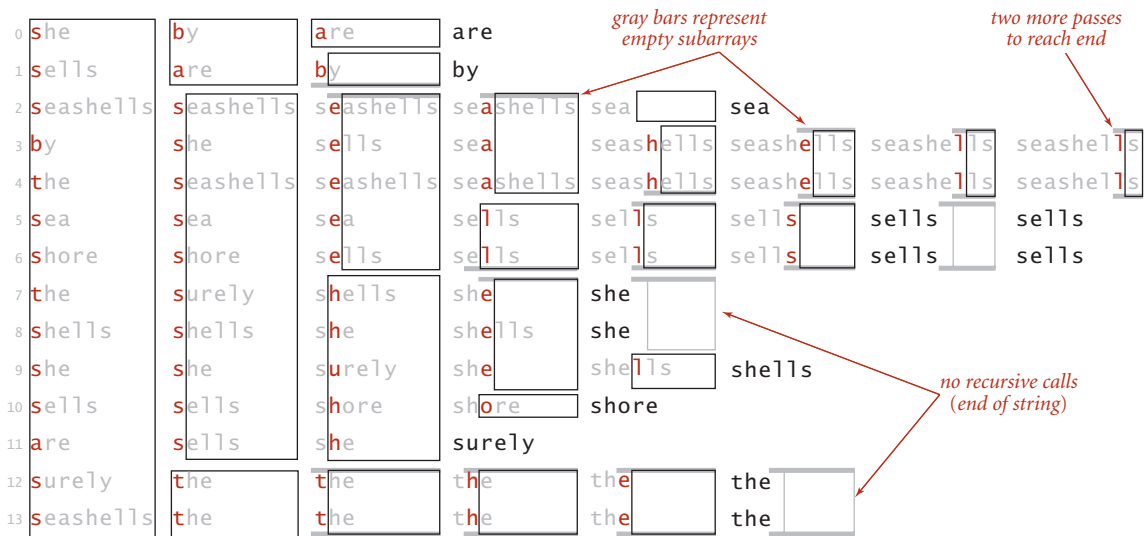

Trace of recursive calls for 3-way string quicksort (no cutoff for small subarrays)

Randomization. As with any quicksort, it is generally worthwhile to shuffle the array beforehand or to use a random partitioning item by swapping the first item with a random one. The primary reason to do so is to protect against worst-case performance in the case that the array is already sorted or nearly sorted.

For string keys, standard quicksort and all the other sorts in CHAPTER 2 are actually MSD string sorts, because the `compareTo()` method in `String` accesses the characters in left-to-right order. That is, `compareTo()` accesses only the leading characters if they are different, the leading two characters if the first characters are the same and the second different, and so forth. For example, if the first characters of the strings are all different, the standard sorts will examine just those characters, thus automatically realizing some of the same performance gain that we seek in MSD string sorting. The essential idea behind 3-way quicksort is to take special action when the leading characters are equal. Indeed, one way to think of ALGORITHM 5.3 is as a way for standard quicksort to keep track of leading characters that are known to be equal. In the small subarrays, where most of the compares in the sort are done, the strings are likely to have numerous equal leading characters. The standard algorithm has to scan over all those characters for each compare; the 3-way algorithm avoids doing so.

Performance. Consider a case where the string keys are long (and are all the same length, for simplicity), but most of the leading characters are equal. In such a situation, the running time of standard quicksort is proportional to the string length *times* $2N \ln N$, whereas the running time of 3-way string quicksort is proportional to N times the string length (to discover all the leading equal characters) *plus* $2N \ln N$ character comparisons (to do the sort on the remaining short keys). That is, 3-way string quicksort requires up to a factor of $2 \ln N$ fewer character compares than normal quicksort. It is not unusual for keys in practical sorting applications to have characteristics similar to this artificial example.

Proposition E. To sort an array of N random strings, 3-way string quicksort uses $\sim 2N \ln N$ character compares, on the average.

Proof: There are two instructive ways to understand this result. First, considering the method to be equivalent to quicksort partitioning on the leading character, then (recursively) using the same method on the subarrays, we should not be surprised that the total number of operations is about the same as for normal quicksort—but they are single-character compares, not full-key compares. Second, considering the method as replacing key-indexed counting by quicksort, we expect that the $N \log_R N$ running time from PROPOSITION D should be multiplied by a factor of $2 \ln R$ because it takes quicksort $2R \ln R$ steps to sort R characters, as opposed to R steps for the same characters in the MSD string sort. We omit the full proof.

As emphasized on page 716, considering random strings is instructive, but more detailed analysis is needed to predict performance for practical situations. Researchers have studied this algorithm in depth and have proved that no algorithm can beat 3-way string quicksort (measured by number of character compares) by more than a constant factor, under very general assumptions. To appreciate its versatility, note that 3-way string quicksort has no direct dependencies on the size of the alphabet.

Example: web logs. As an example where 3-way string quicksort shines, we can consider a typical modern data-processing task. Suppose that you have built a website and want to analyze the traffic that it generates. You can have your system administrator supply you with a web log of all transactions on your site. Among the information associated with a transaction is the domain name of the originating machine. For example, the file `week.1log.txt` on the booksite is a log of one week's transactions on our booksite. Why does 3-way string quicksort do well on such a file? Because the sorted result is replete with long common prefixes that this method does not have to reexamine.

Which string-sorting algorithm should I use? Naturally, we are interested in how the string-sorting methods that we have considered compare to the general-purpose methods that we considered in CHAPTER 2. The following table summarizes the important characteristics of the string-sort algorithms that we have discussed in this section (the rows for quicksort, mergesort, and 3-way quicksort are included from CHAPTER 2, for comparison).

algorithm	stable?	inplace?	order of growth of typical number calls to <code>charAt()</code> to sort N strings from an R -character alphabet (average length w , max length W)		sweet spot
			running time	extra space	
<i>insertion sort for strings</i>	yes	yes	between N and N^2	1	small arrays, arrays in order
<i>quicksort</i>	no	yes	$N \log^2 N$	$\log N$	general-purpose when space is tight
<i>mergesort</i>	yes	no	$N \log^2 N$	N	general-purpose stable sort
<i>3-way quicksort</i>	no	yes	between N and $N \log N$	$\log N$	large numbers of equal keys
<i>LSD string sort</i>	yes	no	NW	N	short fixed-length strings
<i>MSD string sort</i>	yes	no	between N and Nw	$N + WR$	random strings
<i>3-way string quicksort</i>	no	yes	between N and Nw	$W + \log N$	general-purpose, strings with long prefix matches

Performance characteristics of string-sorting algorithms

As in CHAPTER 2, multiplying these growth rates by appropriate algorithm- and data-dependent constants gives an effective way to predict running time.

As explored in the examples that we have already considered and in many other examples in the exercises, different specific situations call for different methods, with appropriate parameter settings. In the hands of an expert (maybe that's you, by now), dramatic savings can be realized for certain situations.

Q&A

- Q.** Does the Java system sort use one of these methods for `String` sorts?
- A.** No, but the standard implementation includes a fast string compare that makes standard sorts competitive with the methods considered here.
- Q.** So, I should just use the system sort for `String` keys?
- A.** Probably yes in Java, though if you have huge numbers of strings or need an exceptionally fast sort, you may wish to switch to `char` arrays instead of `String` values and use a radix sort.
- Q.** What is explanation of the $\log^2 N$ factors on the table in the previous page?
- A.** They reflect the idea that most of the comparisons for these algorithms wind up being between keys with a common prefix of length $\log N$. Recent research has established this fact for random strings with careful mathematical analysis (see booksite for reference).

EXERCISES

5.1.1 Develop a sort implementation that counts the number of different key values, then uses a symbol table to apply key-indexed counting to sort the array. (This method is *not* for use when the number of different key values is large.)

5.1.2 Give a trace for LSD string sort for the keys

```
no is th ti fo al go pe to co to th ai of th pa
```

5.1.3 Give a trace for MSD string sort for the keys

```
no is th ti fo al go pe to co to th ai of th pa
```

5.1.4 Give a trace for 3-way string quicksort for the keys

```
no is th ti fo al go pe to co to th ai of th pa
```

5.1.5 Give a trace for MSD string sort for the keys

```
now is the time for all good people to come to the aid of
```

5.1.6 Give a trace for 3-way string quicksort for the keys

```
now is the time for all good people to come to the aid of
```

5.1.7 Develop an implementation of key-indexed counting that makes use of an array of Queue objects.

5.1.8 Give the number of characters examined by MSD string sort and 3-way string quicksort for a file of N keys $a, aa, aaa, aaaa, aaaaa, \dots$

5.1.9 Develop an implementation of LSD string sort that works for variable-length strings.

5.1.10 What is the total number of characters examined by 3-way string quicksort when sorting N fixed-length strings (all of length W), in the worst case?

CREATIVE PROBLEMS

5.1.11 *Queue sort.* Implement MSD string sorting using queues, as follows: Keep one queue for each bin. On a first pass through the items to be sorted, insert each item into the appropriate queue, according to its leading character value. Then, sort the sublists and stitch together all the queues to make a sorted whole. Note that this method does not involve keeping the `count[]` arrays within the recursive method.

5.1.12 *Alphabet.* Develop an implementation of the `Alphabet` API that is given on page 698 and use it to develop LSD and MSD sorts for general alphabets.

5.1.13 *Hybrid sort.* Investigate the idea of using standard MSD string sort for large arrays, in order to get the advantage of multiway partitioning, and 3-way string quicksort for smaller arrays, in order to avoid the negative effects of large numbers of empty bins.

5.1.14 *Array sort.* Develop a method that uses 3-way string quicksort for keys that are *arrays* of `int` values.

5.1.15 *Sublinear sort.* Develop a sort implementation for `int` values that makes two passes through the array to do an LSD sort on the leading 16 bits of the keys, then does an insertion sort.

5.1.16 *Linked-list sort.* Develop a sort implementation that takes a linked list of nodes with `String` key values as argument and rearranges the nodes so that they appear in sorted order (returning a link to the node with the smallest key). Use 3-way string quicksort.

5.1.17 *In-place key-indexed counting.* Develop a version of key-indexed counting that uses only a constant amount of extra space. Prove that your version is stable or provide a counterexample.

EXPERIMENTS

5.1.18 *Random decimal keys.* Write a static method `randomDecimalKeys` that takes `int` values `N` and `W` as arguments and returns an array of `N` string values that are each `W`-digit decimal numbers.

5.1.19 *Random CA license plates.* Write a static method `randomPlatesCA` that takes an `int` value `N` as argument and returns an array of `N` `String` values that represent CA license plates as in the examples in this section.

5.1.20 *Random fixed-length words.* Write a static method `randomFixedLengthWords` that takes `int` values `N` and `W` as arguments and returns an array of `N` string values that are each strings of `W` characters from the alphabet.

5.1.21 *Random items.* Write a static method `randomItems` that takes an `int` value `N` as argument and returns an array of `N` string values that are each strings of length between 15 and 30 made up of three fields: a 4-character field with one of a set of 10 fixed strings; a 10-char field with one of a set of 50 fixed strings; a 1-character field with one of two given values; and a 15-byte field with random left-justified strings of letters equally likely to be 4 through 15 characters long.

5.1.22 *Timings.* Compare the running times of MSD string sort and 3-way string quicksort, using various key generators. For fixed-length keys, include LSD string sort.

5.1.23 *Array accesses.* Compare the number of array accesses used by MSD string sort and 3-way string sort, using various key generators. For fixed-length keys, include LSD string sort.

5.1.24 *Rightmost character accessed.* Compare the position of the rightmost character accessed for MSD string sort and 3-way string quicksort, using various key generators.

This page intentionally left blank

5.2 TRIES

As with sorting, we can take advantage of properties of strings to develop search methods (symbol-table implementations) that can be more efficient than the general-purpose methods of CHAPTER 3 for typical applications where search keys are strings.

Specifically, the methods that we consider in this section achieve the following performance characteristics in typical applications, even for huge tables:

- Search hits take time proportional to the length of the search key.
- Search misses involve examining only a few characters.

On reflection, these performance characteristics are quite remarkable, one of the crowning achievements of algorithmic technology and a primary factor in enabling the development of the computational infrastructure we now enjoy that has made so much information instantly accessible. Moreover, we can extend the symbol-table API to include character-based operations defined for string keys (but not necessarily for all Comparable types of keys) that are powerful and quite useful in practice, as in the following API:

```
public class StringST<Value>
```

StringST()	<i>create a symbol table</i>
void put(String key, Value val)	<i>put key-value pair into the table (remove key if value is null)</i>
Value get(String key)	<i>value paired with key (null if key is absent)</i>
void delete(String key)	<i>remove key (and its value)</i>
boolean contains(String key)	<i>is there a value paired with key?</i>
boolean isEmpty()	<i>is the table empty?</i>
String longestPrefixOf(String s)	<i>the longest key that is a prefix of s</i>
Iterable<String> keysWithPrefix(String s)	<i>all the keys having s as a prefix</i>
Iterable<String> keysThatMatch(String s)	<i>all the keys that match s (where . matches any character)</i>
int size()	<i>number of key-value pairs</i>
Iterable<String> keys()	<i>all the keys in the table</i>

API for a symbol table with string keys

This API differs from the symbol-table API introduced in CHAPTER 3 in the following aspects:

- We replace the generic type `Key` with the concrete type `String`.
- We add three new methods, `longestPrefixOf()`, `keysWithPrefix()` and `keysThatMatch()`.

We retain the basic conventions of our symbol-table implementations in CHAPTER 3 (no duplicate or null keys and no null values).

As we saw for sorting with string keys, it is often quite important to be able to work with strings from a specified alphabet. Simple and efficient implementations that are the method of choice for small alphabets turn out to be useless for large alphabets because they consume too much space. In such cases, it is certainly worthwhile to add a constructor that allows clients to specify the alphabet. We will consider the implementation of such a constructor later in this section but omit it from the API for now, in order to concentrate on string keys.

The following descriptions of the three new methods use the keys `she sells sea shells by the sea shore` to give examples:

- `longestPrefixOf()` takes a string as argument and returns the longest key in the symbol table that is a prefix of that string. For the keys above, `longestPrefixOf("shell")` is `she` and `longestPrefixOf("shellsort")` is `shells`.
- `keysWithPrefix()` takes a string as argument and returns all the keys in the symbol table having that string as prefix. For the keys above, `keysWithPrefix("she")` is `she` and `shells`, and `keysWithPrefix("se")` is `sells` and `sea`.
- `keysThatMatch()` takes a string as argument and returns all the keys in the symbol table that match that string, in the sense that a period (`.`) in the argument string matches any character. For the keys above, `keysThatMatch(".he")` returns `she` and `the`, and `keysThatMatch("s..")` returns `she` and `sea`.

We will consider in detail implementations and applications of these operations after we have seen the basic symbol-table methods. These particular operations are representative of what is possible with string keys; we discuss several other possibilities in the exercises.

To focus on the main ideas, we concentrate on `put()`, `get()`, and the new methods; we assume (as in CHAPTER 3) default implementations of `contains()` and `isEmpty()`; and we leave implementations of `size()` and `delete()` for exercises. Since strings are `Comparable`, extending the API to also include the ordered operations defined in the ordered symbol-table API in CHAPTER 3 is possible (and worthwhile); we leave those implementations (which are generally straightforward) to exercises and booksite code.

Tries In this section, we consider a search tree known as a *trie*, a data structure built from the characters of the string keys that allows us to use the characters of the search key to guide the search. The name “trie” is a bit of wordplay introduced by E. Fredkin in 1960 because the data structure is used for *retrieval*, but we pronounce it “try” to avoid confusion with “tree.” We begin with a high-level description of the basic properties of tries, including search and insert algorithms, and then proceed to the details of the representation and Java implementation.

Basic properties. As with search trees, tries are data structures composed of *nodes* that contain *links* that are either *null* or references to other nodes. Each node is pointed to by just one other node, which is called its *parent* (except for one node, the *root*, which has no nodes pointing to it), and each node has R links, where R is the alphabet size. Often, tries have a substantial number of null links, so when we draw a trie, we typically omit null links. Although links point to nodes, we can view each link as pointing to a trie, the trie whose root is the referenced node. Each link corresponds to a character value—since each link points to exactly one node, we label each node with the character value corresponding to the link that points to it (except for the root, which has no link pointing to it). Each node also has a corresponding *value*, which may be null or the value associated with one of the string keys in the symbol table. Specifically, we store the value associated with each key in the node corresponding to its last character. It is very important to bear in mind the following fact: *nodes with null values exist to facilitate search in the trie and do not correspond to keys*. An example of a trie is shown at right.

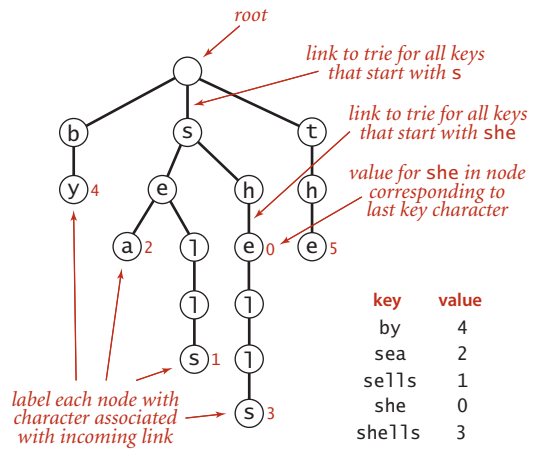

key	value
by	4
sea	2
sell's	1
she	0
shell's	3
the	5

Anatomy of a trie

Search in a trie. Finding the value associated with a given string key in a trie is a simple process, guided by the characters in the search key. Each node in the trie has a link corresponding to each possible string character. We start at the root, then follow the link associated with the first character in the key; from that node we follow the link associated with the second character in the key; from that node we follow the link associated with the third character in the key and

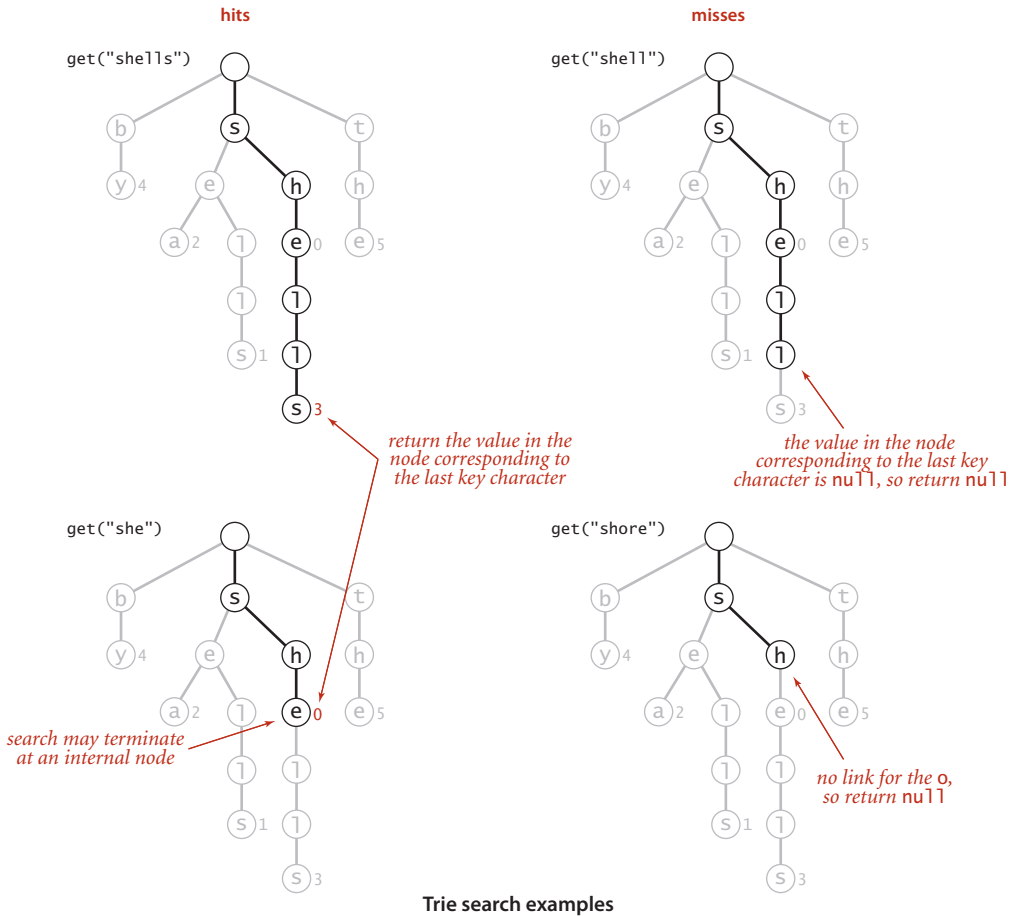

so forth, until reaching the last character of the key or a null link. At this point, one of the following three conditions holds (refer to the figure above for examples):

- The value at the node corresponding to the last character in the key is not null (as in the searches for shell's and she depicted at left above). This result is a *search hit*—the value associated with the key is the value in the node corresponding to its last character.
- The value in the node corresponding to the last character in the key is null (as in the search for shell depicted at top right above). This result is a *search miss*: the key is not in the table.
- The search terminated with a null link (as in the search for shore depicted at bottom right above). This result is also a search miss.

In all cases, the search is accomplished just by examining nodes along a path from the root to another node in the trie.

Insertion into a trie. As with binary search trees, we insert by first doing a search: in a trie that means using the characters of the key to guide us down the trie until reaching the last character of the key or a null link. At this point, one of the following two conditions holds:

- We encountered a null link before reaching the last character of the key. In this case, there is no trie node corresponding to the last character in the key, so we need to create nodes for each of the characters in the key not yet encountered and set the value in the last one to the value to be associated with the key.
- We encountered the last character of the key before reaching a null link. In this case, we set that node's value to the value to be associated with the key (whether or not that value is null), as usual with our associative array convention.

In all cases, we examine or create a node in the trie for each key character. The construction of the trie for our standard indexing client from CHAPTER 3 with the input

she sells sea shells by the sea shore

is shown on the facing page.

Node representation. As mentioned at the outset, our trie diagrams do not quite correspond to the data structures our programs will build, because we do not draw null links. Taking null links into account emphasizes the following important characteristics of tries:

- Every node has R links, one for each possible character.
- Characters and keys are *implicitly* stored in the data structure.

For example, the figure below depicts a trie for keys made up of lowercase letters, with each node having a value and 26 links. The first link points to a subtree for keys beginning with a, the second points to a subtree for substrings beginning with b, and so forth.

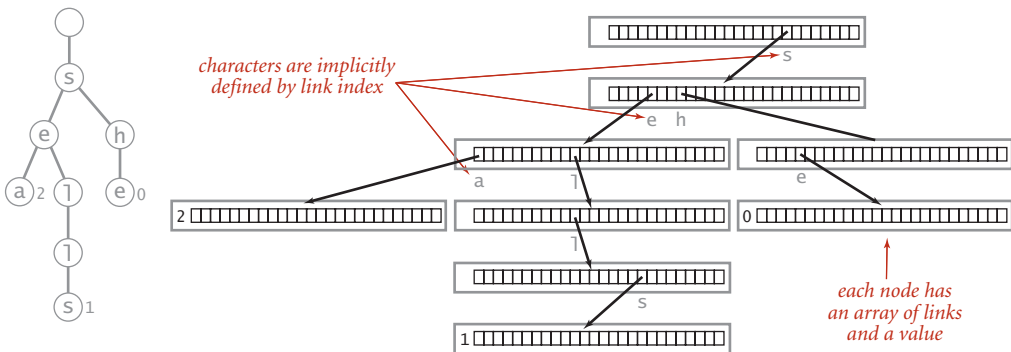

Trie representation ($R = 26$)

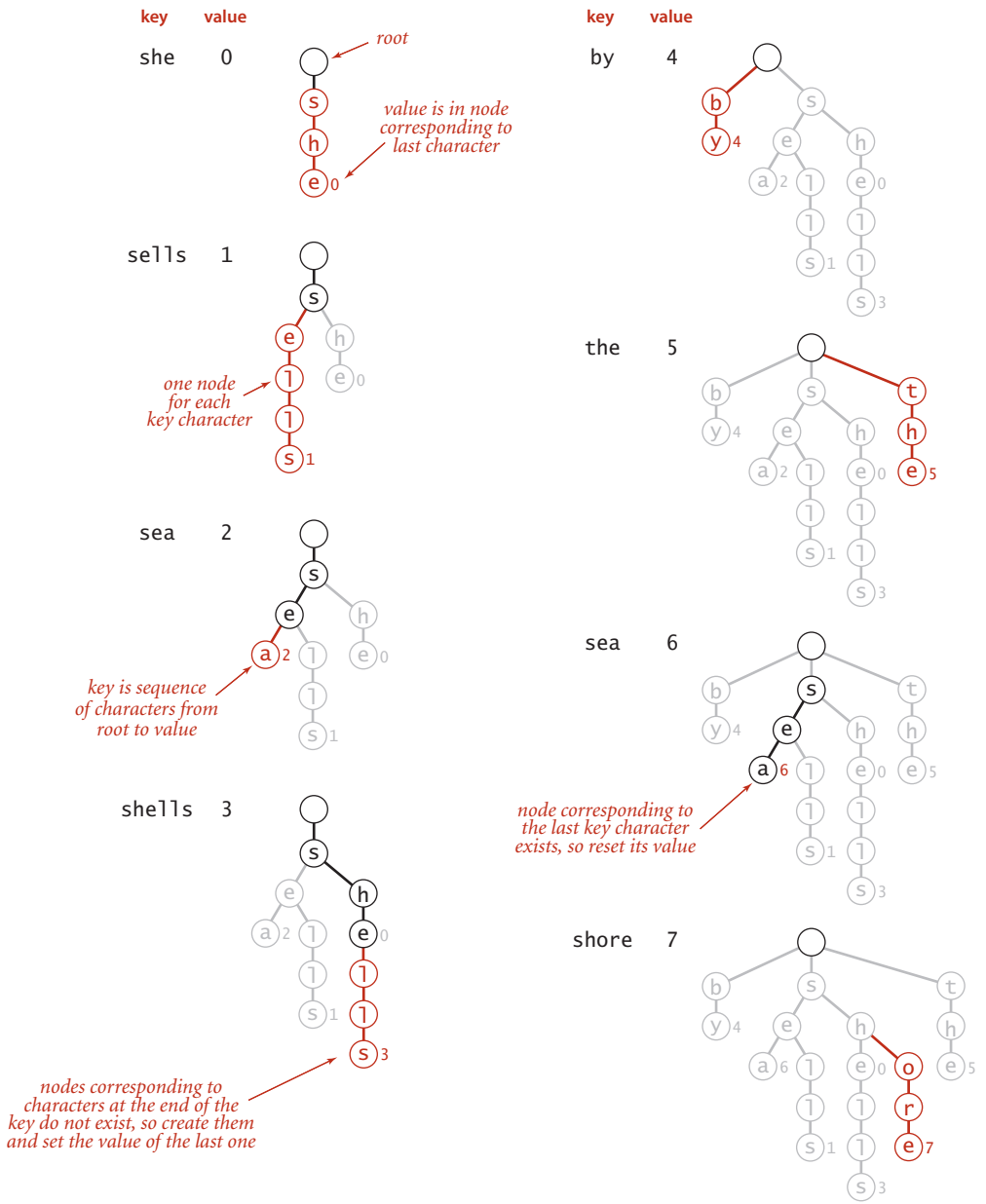

Trie construction trace for standard indexing client

Keys in the trie are implicitly represented by paths from the root that end at nodes with non-null values. For example, the string `sea` is associated with the value 2 in the trie because the 19th link in the root (which points to the trie for all keys that start with `s`) is not null and the 5th link in the node that link refers to (which points to the trie for all keys that start with `se`) is not null, and the first link in the node that link refers to (which points to the trie for all keys that starts with `sea`) has the value 2. Neither the string `sea` nor the characters `s`, `e`, and `a` are stored in the data structure. Indeed, the data structure contains no characters or strings, just links and values. Since the parameter `R` plays such a critical role, we refer to a trie for an `R`-character alphabet as an *R-way trie*.

WITH THESE PREPARATIONS, the symbol-table implementation `TrieST` on the facing page is straightforward. It uses recursive methods like those that we used for search trees in CHAPTER 3, based on a private `Node` class with instance variable `val` for client values and an array `next[]` of `Node` references. The methods are compact recursive implementations that are worthy of careful study. Next, we discuss implementations of the constructor that takes an `Alphabet` as argument and the methods `size()`, `keys()`, `longestPrefixOf()`, `keysWithPrefix()`, `keysThatMatch()`, and `delete()`. These are also easily understood recursive methods, each slightly more complicated than the last.

Size. As for the binary search trees of CHAPTER 3, three straightforward options are available for implementing `size()`:

- An eager implementation where we maintain the number of keys in an instance variable `N`.
- A very eager implementation where we maintain the number of keys in a subtrie as a node instance variable that we update after the recursive calls in `put()` and `delete()`.
- A lazy recursive implementation like the one at right. It traverses all of the nodes in the trie, counting the number having a non-null value.

As with binary search trees, the lazy implementation is instructive but should be avoided because it can lead to performance problems for clients. The eager implementations are explored in the exercises.

```
public int size()
{ return size(root); }

private int size(Node x)
{
    if (x == null) return 0;

    int cnt = 0;
    if (x.val != null) cnt++;
    for (char c = 0; c < R; c++)
        cnt += size(next[c]);

    return cnt;
}
```

Lazy recursive `size()` for tries

ALGORITHM 5.4 Trie symbol table

```
public class TrieST<Value>
{
    private static int R = 256; // radix
    private Node root;         // root of trie

    private static class Node
    {
        private Object val;
        private Node[] next = new Node[R];
    }

    public Value get(String key)
    {
        Node x = get(root, key, 0);
        if (x == null) return null;
        return (Value) x.val;
    }

    private Node get(Node x, String key, int d)
    { // Return value associated with key in the subtrie rooted at x.
        if (x == null) return null;
        if (d == key.length()) return x;
        char c = key.charAt(d); // Use dth key char to identify subtrie.
        return get(x.next[c], key, d+1);
    }

    public void put(String key, Value val)
    { root = put(root, key, val, 0); }

    private Node put(Node x, String key, Value val, int d)
    { // Change value associated with key if in subtrie rooted at x.
        if (x == null) x = new Node();
        if (d == key.length()) { x.val = val; return x; }
        char c = key.charAt(d); // Use dth key char to identify subtrie.
        x.next[c] = put(x.next[c], key, val, d+1);
        return x;
    }
}
```

This code uses an R -way trie to implement a symbol table. Additional methods in the string symbol-table API of page 730 are presented in the next several pages. Modifying this code to handle keys from specialized alphabets is straightforward (see page 740). The value in Node has to be an Object because Java does not support arrays of generics; we cast values back to Value in get().

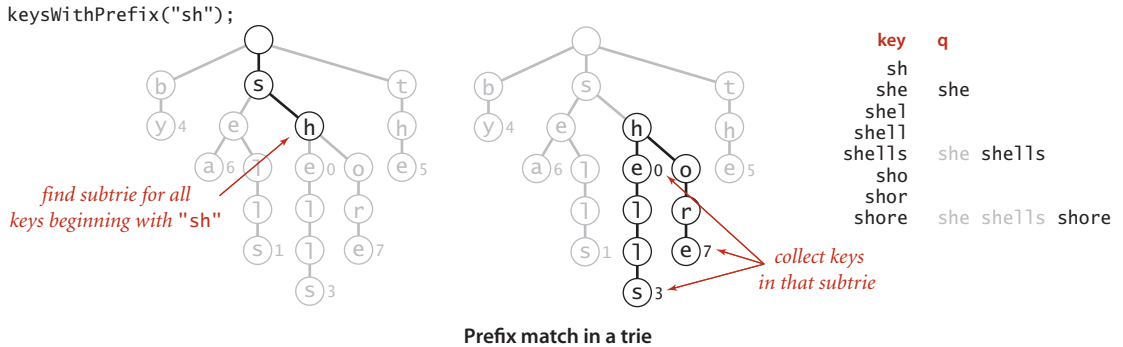

Wildcard match. To implement `keysThatMatch()`, we use a similar process, but add an argument specifying the pattern to `collect()` and add a test to make a recursive call for all links when the pattern character is a wildcard or only for the link corresponding to the pattern character otherwise, as in the code below. Note also that we do not need to consider keys longer than the pattern.

Longest prefix. To find the longest key that is a prefix of a given string, we use a recursive method like `get()` that keeps track of the length of the longest key found on the search path (by passing it as a parameter to the recursive method, updating the value

```
public Iterable<String> keysThatMatch(String pat)
{
    Queue<String> q = new Queue<String>();
    collect(root, "", pat, q);
    return q;
}

public void collect(Node x, String pre, String pat, Queue<String> q)
{
    int d = pre.length();
    if (x == null) return;
    if (d == pat.length() && x.val != null) q.enqueue(pre);
    if (d == pat.length()) return;

    char next = pat.charAt(d);
    for (char c = 0; c < R; c++)
        if (next == '.' || next == c)
            collect(x.next[c], pre + c, pat, q);
}
```

Wildcard match in a trie

```

public String longestPrefixOf(String s)
{
    int length = search(root, s, 0, 0);
    return s.substring(0, length);
}

private int search(Node x, String s, int d, int length)
{
    if (x == null) return length;
    if (x.val != null) length = d;
    if (d == s.length()) return length;
    char c = s.charAt(d);
    return search(x.next[c], s, d+1, length);
}

```

Matching the longest prefix of a given string

whenever a node with a non-null value is encountered). The search ends when the end of the string or a null link is encountered, whichever comes first.

Deletion. The first step needed to delete a key-value pair from a trie is to use a normal search to find the node corresponding to the key and set the corresponding value to `null`. If that node has a non-null link to a child, then no more work is required; if all the links are null, we need to remove the node from the data structure. If doing so leaves all the links null in its parent, we need to remove that node, and so forth. The implementation on the facing page demonstrates that this action can be accomplished with remarkably little code, using our standard recursive setup: after the recursive calls for a node `x`, we return `null` if the client value and all of the links in a node are `null`; otherwise we return `x`.

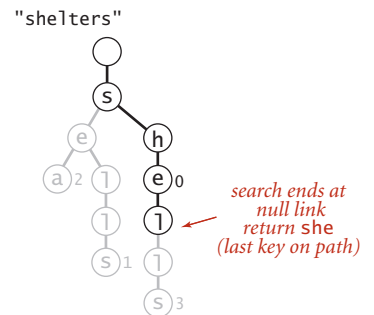
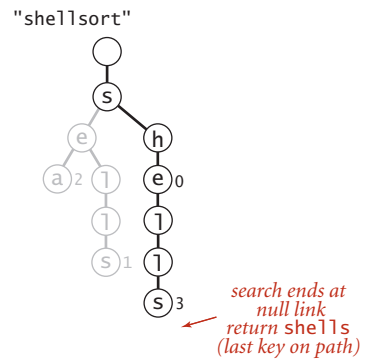
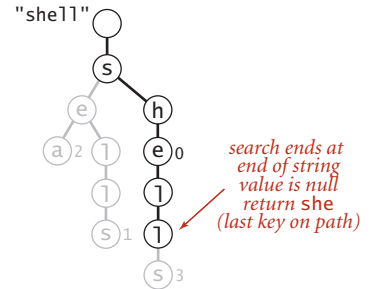
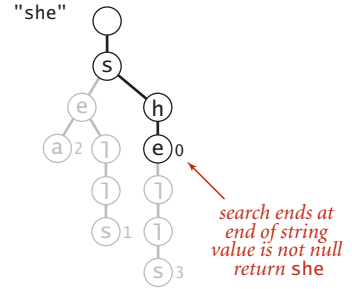

Possibilities for `longestPrefixOf()`

Alphabet. As usual, ALGORITHM 5.4 is coded for Java String keys, but it is a simple matter to modify the implementation to handle keys taken from any alphabet, as follows:

- Implement a constructor that takes an Alphabet as argument, which sets an Alphabet instance variable to that argument value and the instance variable R to the number of characters in the alphabet.
- Use the toIndex() method from Alphabet in get() and put() to convert string characters to indices between 0 and R-1.
- Use the toChar() method from Alphabet to convert indices between 0 and R-1 to char values. This operation is not needed in get() and put() but is important in the implementations of keys(), keysWithPrefix(), and keysThatMatch().

With these changes, you can save a considerable amount of space (use only R links per node) when you know that your keys are taken from a small alphabet, at the cost of the time required to do the conversions between characters and indices.

```
public void delete(String key)
{ root = delete(root, key, 0); }

private Node delete(Node x, String key, int d)
{
    if (x == null) return null;
    if (d == key.length())
        x.val = null;
    else
    {
        char c = key.charAt(d);
        x.next[c] = delete(x.next[c], key, d+1);
    }
    if (x.val != null) return x;
    for (char c = 0; c < R; c++)
        if (x.next[c] != null) return x;
    return null;
}
```

Deleting a key (and its associated value) from a trie

delete("shells");

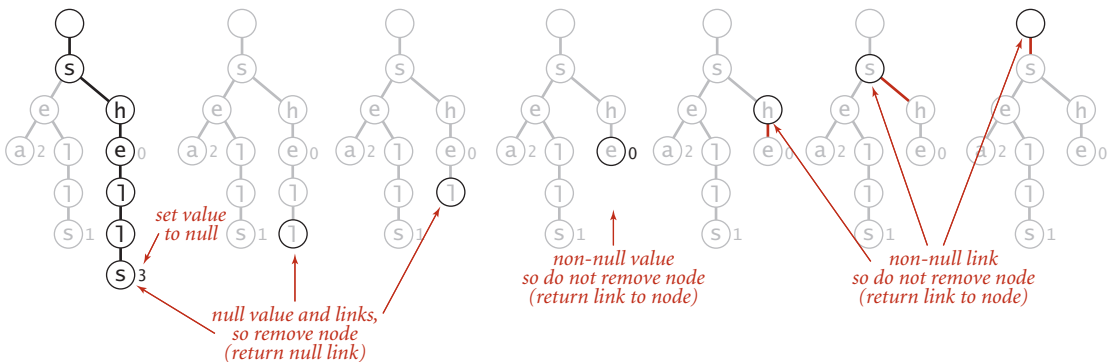

Deleting a key (and its associated value) from a trie

THE CODE THAT WE HAVE CONSIDERED is a compact and complete implementation of the string symbol-table API that has broadly useful practical applications. Several variations and extensions are discussed in the exercises. Next, we consider basic properties of tries, and some limitations on their utility.

Properties of tries As usual, we are interested in knowing the amount of time and space required to use tries in typical applications. Tries have been extensively studied and analyzed, and their basic properties are relatively easy to understand and to apply.

Proposition F. The linked structure (shape) of a trie is independent of the key insertion/deletion order: there is a unique trie for any given set of keys.

Proof: Immediate, by induction on the subtrees.

This fundamental fact is a distinctive feature of tries: for all of the other search tree structures that we have considered so far, the tree that we construct depends both on the set of keys and on the order in which we insert those keys.

Worst-case time bound for search and insert. How long does it take to find the value associated with a key? For BSTs, hashing, and other methods in CHAPTER 4, we needed mathematical analysis to study this question, but for tries it is very easy to answer:

Proposition G. The number of array accesses when searching in a trie or inserting a key into a trie is at most 1 plus the length of the key.

Proof: Immediate from the code. The recursive `get()` and `put()` implementations carry an argument `d` that starts at 0, increments for each call, and is used to stop the recursion when it reaches the key length.

From a theoretical standpoint, the implication of PROPOSITION G is that tries are *optimal* for search hit—we could not expect to do better than search time proportional to the length of the search key. Whatever algorithm or data structure we are using, we cannot know that we have found a key that we seek without examining all of its characters. From a practical standpoint this guarantee is important because *it does not depend on the number of keys*: when we are working with 7-character keys like license plate numbers, we know that we need to examine at most 8 nodes to search or insert; when we are working with 20-digit account numbers, we only need to examine at most 21 nodes to search or insert.

Expected time bound for search miss. Suppose that we are searching for a key in a trie and find that the link in the root node that corresponds to its first character is null. In this case, we know that the key is not in the table on the basis of examining just *one* node. This case is typical: one of the most important properties of tries is that search misses typically require examining just a few nodes. If we assume that the keys are drawn from the random string model (each character is equally likely to have any one of the R different character values) we can prove this fact:

Proposition H. The average number of nodes examined for search miss in a trie built from N random keys over an alphabet of size R is $\sim \log_R N$.

Proof sketch (for readers who are familiar with probabilistic analysis): The probability that each of the N keys in a random trie differs from a random search key in at least one of the leading t characters is $(1 - R^{-t})^N$. Subtracting this quantity from 1 gives the probability that one of the keys in the trie matches the search key in all of the leading t characters. In other words, $1 - (1 - R^{-t})^N$ is the probability that the search requires more than t character compares. From probabilistic analysis, the sum for $t = 0, 1, 2, \dots$ of the probabilities that an integer random variable is $>t$ is the average value of that random variable, so the average search cost is

$$1 - (1 - R^{-1})^N + 1 - (1 - R^{-2})^N + \dots + 1 - (1 - R^{-t})^N + \dots$$

Using the elementary approximation $(1 - 1/x)^x \sim e^{-1}$, we find the search cost to be approximately

$$(1 - e^{-N/R^1}) + (1 - e^{-N/R^2}) + \dots + (1 - e^{-N/R^t}) + \dots$$

The summand is extremely close to 1 for approximately $\ln_R N$ terms with R^t substantially smaller than N ; it is extremely close to 0 for all the terms with R^t substantially greater than N ; and it is somewhere between 0 and 1 for the few terms with $R^t \approx N$. So the grand total is about $\log_R N$.

From a practical standpoint, the most important implication of this proposition is that *search miss does not depend on the key length*. For example, it says that unsuccessful search in a trie built with 1 million random keys will require examining only three or four nodes, whether the keys are 7-digit license plates or 20-digit account numbers. While it is unreasonable to expect truly random keys in practical applications, it *is* reasonable to hypothesize that the behavior of trie algorithms for keys in typical applica-

tions is described by this model. Indeed, this sort of behavior is widely seen in practice and is an important reason for the widespread use of tries.

Space. How much space is needed for a trie? Addressing this question (and understanding how much space is *available*) is critical to using tries effectively.

Proposition I. The number of links in a trie is between RN and RNw , where w is the average key length.

Proof: Every key in the trie has a node containing its associated value that also has R links, so the number of links is at least RN . If the first characters of all the keys are different, then there is a node with R links for every key character, so the number of links is R times the total number of key characters, or RNw .

The table on the facing page shows the costs for some typical applications that we have considered. It illustrates the following rules of thumb for tries:

- When keys are short, the number of links is close to RN .
- When keys are long, the number of links is close to RNw .
- Therefore, decreasing R can save a huge amount of space.

A more subtle message of this table is that it is important to understand the properties of the keys to be inserted before deploying tries in an application.

One-way branching. The primary reason that trie space is excessive for long keys is that long keys tend to have long tails in the trie, with each node having a single link to the next node (and, therefore, $R-1$ null links). This situation is not difficult to correct (see EXERCISE 5.2.11). A trie might also have internal one-way branching. For example, two long keys may be equal except for their last character. This situation is a bit more difficult to address (see EXERCISE 5.2.12). These changes can make trie space usage a less important factor

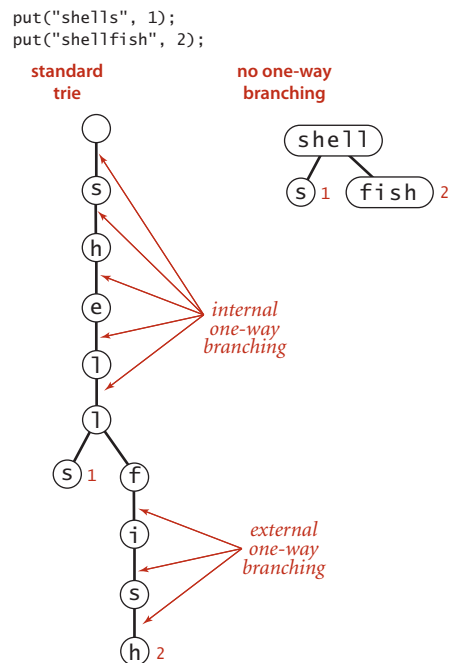

Removing one-way branching in a trie

than for the straightforward implementation that we have considered, but they are not necessarily effective in practical applications. Next, we consider an alternative approach to reducing space usage for tries.

THE BOTTOM LINE is this: *do not try to use ALGORITHM 5.4 for large numbers of long keys taken from large alphabets*, because it will require space proportional to R times the total number of key characters. Otherwise, if you can afford the space, trie performance is difficult to beat.

application	typical key	average length w	alphabet size R	links in trie built from 1 million keys
<i>CA license plates</i>	4PGC938	7	256	256 million
<i>account numbers</i>	02400019992993299111	20	256	4 billion
<i>URLs</i>	www.cs.princeton.edu	28	10	256 million
<i>text processing</i>	seashe11s	11	256	4 billion
<i>proteins in genomic data</i>	ACTGACTG	8	256	256 million
			4	4 million

Space requirements for typical tries

Ternary search tries (TSTs) To help us avoid the excessive space cost associated with R -way tries, we now consider an alternative representation: the *ternary search trie* (TST). In a TST, each node has a character, *three* links, and a value. The three links correspond to keys whose current characters are less than, equal to, or greater than the node's character. In the R -way tries of ALGORITHM 5.4, trie nodes are represented by R links, with the character corresponding to each non-null link implicitly represented by its index. In the corresponding TST, characters appear *explicitly* in nodes—we find characters corresponding to keys only when we are traversing the middle links.

Search and insert. The search and insert code for implementing our symbol-table API with TSTs writes itself. To search, we compare the first character in the key with the character at the root. If it is less, we take the left link; if it is greater, we take the right link; and if it is equal, we take the middle link and move to the next search key character. In each case, we apply

the algorithm recursively. We terminate with a *search miss* if we encounter a null link or if the node where the search ends has a null value, and we terminate with a *search hit* if the node where the search ends has a non-null value. To insert a new key, we search, then add new nodes for the characters in the tail of the key, just as we did for tries. ALGORITHM 5.5 gives the details of the implementation of these methods.

Using this arrangement is equivalent to implementing each R -way trie node as a binary search tree that uses as keys the characters corresponding to non-null links. By contrast, ALGORITHM 5.4 uses a key-indexed array. A

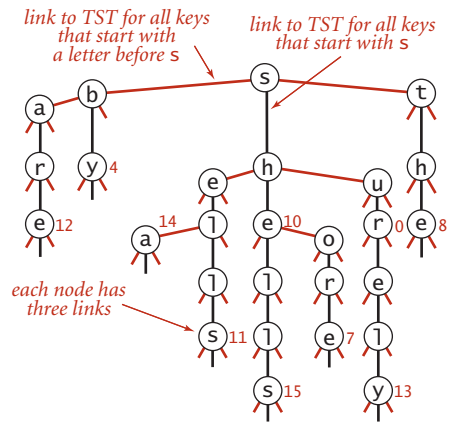
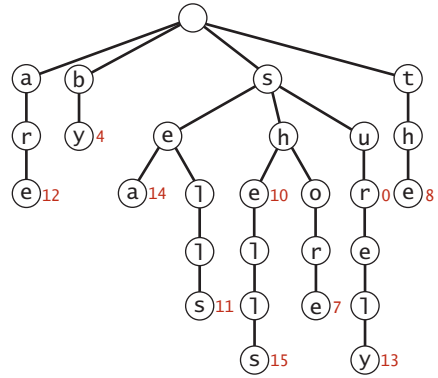

TST representation of a trie

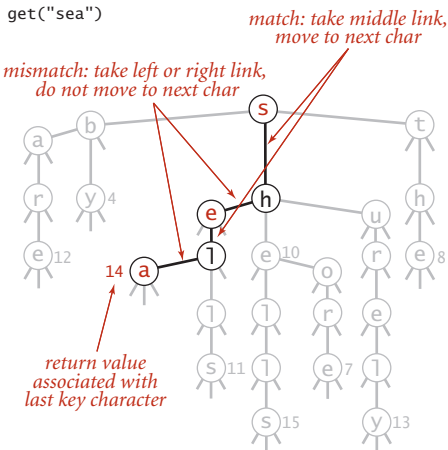

TST search example

ALGORITHM 5.5 TST symbol table

```

public class TST<Value>
{
    private Node root;           // root of trie

    private class Node
    {
        char c;                 // character
        Node left, mid, right;  // left, middle, and right subtrees
        Value val;             // value associated with string
    }

    public Value get(String key) // same as for tries (See page 737).
    private Node get(Node x, String key, int d)
    {
        if (x == null) return null;
        char c = key.charAt(d);
        if (c < x.c) return get(x.left, key, d);
        else if (c > x.c) return get(x.right, key, d);
        else if (d < key.length() - 1)
            return get(x.mid, key, d+1);
        else return x;
    }

    public void put(String key, Value val)
    { root = put(root, key, val, 0); }

    private Node put(Node x, String key, Value val, int d)
    {
        char c = key.charAt(d);
        if (x == null) { x = new Node(); x.c = c; }
        if (c < x.c) x.left = put(x.left, key, val, d);
        else if (c > x.c) x.right = put(x.right, key, val, d);
        else if (d < key.length() - 1)
            x.mid = put(x.mid, key, val, d+1);
        else x.val = val;
        return x;
    }
}

```

This implementation uses a char value *c* and three links per node to build string search tries where subtrees have keys whose first character is less than *c* (left), equal to *c* (middle), and greater than *c* (right).

TST and its corresponding trie are illustrated above. Continuing the correspondence described in CHAPTER 3 between binary search trees and sorting algorithms, we see that TSTs correspond to 3-way string quicksort in the same way that BSTs correspond to quicksort and tries correspond to MSD sorting. The figures on page 714 and 721, which show the recursive call structure for MSD and 3-way three-way string quicksort (respectively), correspond precisely to the trie and TST drawn on page 746 for that set of keys. Space for links in tries corresponds to the space for counters in string sorting; 3-way branching provides an effective solution to both problems.

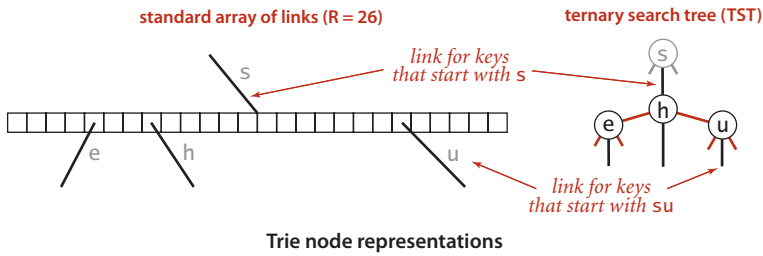

Properties of TSTs A TST is a compact representation of an R -way trie, but the two data structures have remarkably different properties. Perhaps the most important difference is that PROPERTY A does not hold for TSTs: the BST representations of each trie node depend on the order of key insertion, as with any other BST.

Space. The most important property of TSTs is that they have just three links in each node, so a TST requires far less space than the corresponding trie.

Proposition J. The number of links in a TST built from N string keys of average length w is between $3N$ and $3Nw$.

Proof. Immediate, by the same argument as for PROPOSITION I.

Actual space usage is generally less than the upper bound of three links per character, because keys with common prefixes share nodes at high levels in the tree.

Search cost. To determine the cost of search (and insert) in a TST, we multiply the cost for the corresponding trie by the cost of traversing the BST representation of each trie node..

Proposition K. A search miss in a TST built from N random string keys requires $\sim \ln N$ character compares, on the average. A search hit or an insertion in a TST uses a character compare for each character in the search key.

Proof: The search hit/insertion cost is immediate from the code. The search miss cost is a consequence of the same arguments discussed in the proof sketch of PROPOSITION H. We assume that all but a constant number of the nodes on the search path (a few at the top) act as random BSTs on R character values with average path length $\ln R$, so we multiply the time cost $\log_R N = \ln N / \ln R$ by $\ln R$.

In the worst case, a node might be a full R -way node that is unbalanced, stretched out like a singly linked list, so we would need to multiply by a factor of R . More typically, we might expect to do $\ln R$ or fewer character compares at the first level (since the root node behaves like a random BST on the R different character values) and perhaps at a few other levels (if there are keys with a common prefix and up to R different values on the character following the prefix), and to do only a few compares for most characters (since most trie nodes are sparsely populated with non-null links). Search misses are likely to involve only a few character compares, ending at a null link high in the trie,

and search hits involve only about one compare per search key character, since most of them are in nodes with one-way branching at the bottom of the trie.

Alphabet. The prime virtue of using TSTs is that they adapt gracefully to irregularities in search keys that are likely to appear in practical applications. In particular, note that there is no reason to allow for strings to be built from a client-supplied alphabet, as was crucial for tries. There are two main effects. First, keys in practical applications come from large alphabets, and usage of particular characters in the character sets is far from uniform. With TSTs, we can use a 256-character ASCII encoding or a 65,536-character Unicode encoding without having to worry about the excessive costs of nodes with 256- or 65,536-way branching, and without having to determine which sets of characters are relevant. Unicode strings in non-Roman alphabets can have thousands of characters—TSTs are especially appropriate for standard Java `String` keys that consist of such characters. Second, keys in practical applications often have a structured format, differing from application to application, perhaps using only letters in one part of the key, only digits in another part of the key. In our CA license plate example, the second, third, and fourth characters are uppercase letter ($R = 26$) and the other characters are decimal digits ($R = 10$). In a TST for such keys, some of the trie nodes will be represented as 10-node BSTs (for places where all keys have digits) and others will be represented as 26-node BSTs (for places where all keys have letters). This structure develops automatically, without any need for special analysis of the keys.

Prefix match, collecting keys, and wildcard match. Since a TST represents a trie, implementations of `longestPrefixOf()`, `keys()`, `keysWithPrefix()`, and `keysThatMatch()` are easily adapted from the corresponding code for tries in the previous section, and a worthwhile exercise for you to cement your understanding of both tries and TSTs (see EXERCISE 5.2.9). The same tradeoff as for search (linear memory usage but an extra $\ln R$ multiplicative factor per character compare) holds.

Deletion. The `delete()` method for TSTs requires more work. Essentially, each character in the key to be deleted belongs to a BST. In a trie, we could remove the link corresponding to a character by setting the corresponding entry in the array of links to `null`; in a TST, we have to use BST node deletion to remove the node corresponding to the character.

Hybrid TSTs. An easy improvement to TST-based search is to use a large explicit multiway node at the root. The simplest way to proceed is to keep a table of R TSTs: one for each possible value of the first character in the keys. If R is not large, we might use the first two letters of the keys (and a table of size R^2). For this method to be effective, the leading digits of the keys must be well-distributed. The resulting hybrid search

algorithm corresponds to the way that a human might search for names in a telephone book. The first step is a multiway decision (“Let’s see, it starts with ‘A’”), followed perhaps by some two-way decisions (“It’s before ‘Andrews,’ but after ‘Aitken,’”), followed by sequential character matching (“‘Algonquin,’ ... No, ‘Algorithms’ isn’t listed, because nothing starts with ‘Algor!’”). These programs are likely to be among the fastest available for searching with string keys.

One-way branching. Just as with tries, we can make TSTs more efficient in their use of space by putting keys in leaves at the point where they are distinguished and by eliminating one-way branching between internal nodes.

Proposition L. A search or an insertion in a TST built from N random string keys with no external one-way branching and R^t -way branching at the root requires roughly $\ln N - t \ln R$ character compares, on the average.

Proof: These rough estimates follow from the same argument we used to prove PROPOSITION K. We assume that all but a constant number of the nodes on the search path (a few at the top) act as random BSTs on R character values, so we multiply the time cost by $\ln R$.

DESPITE THE TEMPTATION to tune the algorithm to peak performance, we should not lose sight of the fact that one of the most attractive features of TSTs is that they free us from having to worry about application-specific dependencies, often providing good performance without any tuning.

Which string symbol-table implementation should I use? As with string sorting, we are naturally interested in how the string-searching methods that we have considered compare to the general-purpose methods that we considered in CHAPTER 3. The following table summarizes the important characteristics of the algorithms that we have discussed in this section (the rows for BSTs, red-black BSTs and hashing are included from CHAPTER 3, for comparison). For a particular application, these entries must be taken as indicative, not definitive, since so many factors (such as characteristics of keys and mix of operations) come into play when studying symbol-table implementations.

algorithm (data structure)	typical growth rate for N strings from an R -character alphabet (average length w)		sweet spot
	characters examined for search miss	memory usage	
<i>binary tree search</i> (BST)	$c_1 (\lg N)^2$	$64N$	randomly ordered keys
<i>2-3 tree search</i> (red-black BST)	$c_2 (\lg N)^2$	$64N$	guaranteed performance
<i>linear probing[†]</i> (parallel arrays)	w	$32N$ to $128N$	built-in types cached hash values
<i>trie search</i> (R -way trie)	$\log_R N$	$(8R+56)N$ to $(8R+56)Nw$	short keys small alphabets
<i>trie search</i> (TST)	$1.39 \lg N$	$64N$ to $64Nw$	nonrandom keys

Performance characteristics of string-searching algorithms

If space is available, R -way tries provide the fastest search, essentially completing the job with a *constant* number of character compares. For large alphabets, where space may not be available for R -way tries, TSTs are preferable, since they use a logarithmic number of *character* compares, while BSTs use a logarithmic number of *key* compares. Hashing can be competitive, but, as usual, cannot support ordered symbol-table operations or extended character-based API operations such as prefix or wildcard match.

Q&A

Q. Does the Java system sort use one of these methods for searching with `String` keys?

A. No.

EXERCISES

5.2.1 Draw the *R*-way trie that results when the keys

no is th ti fo al go pe to co to th ai of th pa

are inserted in that order into an initially empty trie (do not draw null links).

5.2.2 Draw the TST that results when the keys

no is th ti fo al go pe to co to th ai of th pa

are inserted in that order into an initially empty TST.

5.2.3 Draw the *R*-way trie that results when the keys

now is the time for all good people to come to the aid of

are inserted in that order into an initially empty trie (do not draw null links).

5.2.4 Draw the TST that results when the keys

now is the time for all good people to come to the aid of

are inserted in that order into an initially empty TST.

5.2.5 Develop nonrecursive versions of TrieST and TST.

5.2.6 Implement the following API, for a StringSET data type:

```
public class StringSET
```

StringSET()	<i>create a string set</i>
void add(String key)	<i>put key into the set</i>
void delete(String key)	<i>remove key from the set</i>
boolean contains(String key)	<i>is key in the set?</i>
boolean isEmpty()	<i>is the set empty?</i>
int size()	<i>number of keys in the set</i>
int toString()	<i>string representation of the set</i>

API for a string set data type

CREATIVE PROBLEMS

5.2.7 *Empty string in TSTs.* The code in TST does not handle the empty string properly. Explain the problem and suggest a correction.

5.2.8 *Ordered operations for tries.* Implement the `floor()`, `ceil()`, `rank()`, and `select()` (from our standard ordered ST API from CHAPTER 3) for `TrieST`.

5.2.9 *Extended operations for TSTs.* Implement `keys()` and the extended operations introduced in this section—`longestPrefixOf()`, `keysWithPrefix()`, and `keysThatMatch()`—for TST.

5.2.10 *Size.* Implement very eager `size()` (that keeps in each node the number of keys in its subtree) for `TrieST` and TST.

5.2.11 *External one-way branching.* Add code to `TrieST` and TST to eliminate external one-way branching.

5.2.12 *Internal one-way branching.* Add code to `TrieST` and TST to eliminate internal one-way branching.

5.2.13 *Hybrid TST with R^2 -way branching at the root.* Add code to TST to do multiway branching at the first two levels, as described in the text.

5.2.14 *Unique substrings of length L .* Write a TST client that reads in text from standard input and calculates the number of unique substrings of length L that it contains. For example, if the input is `cgcgggcgcg`, then there are five unique substrings of length 3: `cgc`, `cgg`, `gcg`, `ggc`, and `ggg`. *Hint:* Use the string method `substring(i, i + L)` to extract the i th substring, then insert it into a symbol table.

5.2.15 *Unique substrings.* Write a TST client that reads in text from standard input and calculates the number of distinct substrings of any length. This can be done very efficiently with a suffix tree—see CHAPTER 6

5.2.16 *Document similarity.* Write a TST client with a static method that takes an `int` value L and two file names as command-line arguments and computes the L -similarity of the two documents: the Euclidean distance between the frequency vectors defined by the number of occurrences of each trigram divided by the number of trigrams. Include a static method `main()` that takes an `int` value L as command-line argument and a list of file names from standard input and prints a matrix showing the L -similarity of all pairs of documents.

CREATIVE PROBLEMS *(continued)*

5.2.17 *Spell checking.* Write a TST client `SpellChecker` that takes as command-line argument the name of a file containing a dictionary of words in the English language, and then reads a string from standard input and prints out any word that is not in the dictionary. Use a string set.

5.2.18 *Whitelist.* Write a TST client that solves the whitelisting problem presented in SECTION 1.1 and revisited in SECTION 3.5 (see page 491).

5.2.19 *Random phone numbers.* Write a `TrieST` client (with $R = 10$) that takes as command line argument an `int` value N and prints N random phone numbers of the form `(xxx) xxx-xxxx`. Use a symbol table to avoid choosing the same number more than once. Use the file `AreaCodes.txt` from the booksite to avoid printing out bogus area codes.

5.2.20 *Contains prefix.* Add a method `containsPrefix()` to `StringSET` (see EXERCISE 5.2.6) that takes a string `s` as input and returns `true` if there is a string in the set that contains `s` as a prefix.

5.2.21 *Substring matches.* Given a list of (short) strings, your goal is to support queries where the user looks up a string `s` and your job is to report back all strings in the list that contain `s`. Design an API for this task and develop a TST client that implements your API. *Hint:* Insert the suffixes of each word (e.g., `string`, `tring`, `ring`, `ing`, `ng`, `g`) into the TST.

5.2.22 *Typing monkeys.* Suppose that a typing monkey creates random words by appending each of 26 possible letter with probability p to the current word and finishes the word with probability $1 - 26p$. Write a program to estimate the frequency distribution of the lengths of words produced. If "abc" is produced more than once, count it only once.

EXPERIMENTS

5.2.23 *Duplicates (revisited again)*. Redo EXERCISE 3.5.30 using `StringSET` (see EXERCISE 5.2.6) instead of `HashSet`. Compare the running times of the two approaches. Then use `Dedup` to run the experiments for $N = 10^7$, 10^8 , and 10^9 , repeat the experiments for random long values and discuss the results.

5.2.24 *Spell checker*. Redo EXERCISE 3.5.31, which uses the file `dictionary.txt` from the booksite and the `BlackFilter` client on page 491 to print all misspelled words in a text file. Compare the performance of `TrieST` and `TST` for the file `war.txt` with this client and discuss the results.

5.2.25 *Dictionary*. Redo EXERCISE 3.5.32: Study the performance of a client like `LookupCSV` (using `TrieST` and `TST`) in a scenario where performance matters. Specifically, design a query-generation scenario instead of taking commands from standard input, and run performance tests for large inputs and large numbers of queries.

5.2.26 *Indexing*. Redo EXERCISE 3.5.33: Study a client like `LookupIndex` (using `TrieST` and `TST`) in a scenario where performance matters. Specifically, design a query-generation scenario instead of taking commands from standard input, and run performance tests for large inputs and large numbers of queries.

A short history The algorithms that we examine have an interesting history; we summarize it here to help place the various methods in perspective.

There is a simple brute-force algorithm for substring search that is in widespread use. While it has a worst-case running time proportional to MN , the strings that arise in many applications lead to a running time that is (except in pathological cases) proportional to $M + N$. Furthermore, it is well-suited to standard architectural features on most computer systems, so an optimized version provides a standard benchmark that is difficult to beat, even with a clever algorithm.

In 1970, S. Cook proved a theoretical result about a particular type of abstract machine that implied the existence of an algorithm that solves the substring search problem in time proportional to $M + N$ in the worst case. D. E. Knuth and V. R. Pratt laboriously followed through the construction Cook used to prove his theorem (which was not intended to be practical) and refined it into a relatively simple and practical algorithm. This seemed a rare and satisfying example of a theoretical result with immediate (and unexpected) practical applicability. But it turned out that J. H. Morris had discovered virtually the same algorithm as a solution to an annoying problem confronting him when implementing a text editor (he wanted to avoid having to “back up” in the text string). The fact that the same algorithm arose from two such different approaches lends it credibility as a fundamental solution to the problem.

Knuth, Morris, and Pratt didn't get around to publishing their algorithm until 1976, and in the meantime R. S. Boyer and J. S. Moore (and, independently, R. W. Gosper) discovered an algorithm that is much faster in many applications, since it often examines only a fraction of the characters in the text string. Many text editors use this algorithm to achieve a noticeable decrease in response time for substring search.

Both the Knuth-Morris-Pratt (KMP) and the Boyer-Moore algorithms require some complicated preprocessing on the pattern that is difficult to understand and has limited the extent to which they are used. (In fact, the story goes that an unknown systems programmer found Morris's algorithm too difficult to understand and replaced it with a brute-force implementation.)

In 1980, M. O. Rabin and R. M. Karp used hashing to develop an algorithm almost as simple as the brute-force algorithm that runs in time proportional to $M + N$ with very high probability. Furthermore, their algorithm extends to two-dimensional patterns and text, which makes it more useful than the others for image processing.

This story illustrates that the search for a better algorithm is still very often justified; indeed, one suspects that there are still more developments on the horizon even for this classic problem.

Brute-force substring search An obvious method for substring search is to check, for each possible position in the text at which the pattern could match, whether it does in fact match. The `search()` method below operates in this way to find the first occurrence of a pattern string `pat` in a text string `txt`. The program keeps one pointer

```
public static int search(String pat, String txt)
{
    int M = pat.length();
    int N = txt.length();
    for (int i = 0; i <= N - M; i++)
    {
        int j;
        for (j = 0; j < M; j++)
            if (txt.charAt(i+j) != pat.charAt(j))
                break;
        if (j == M) return i; // found
    }
    return N; // not found
}
```

Brute-force substring search

compares find a mismatch with the first character of the pattern. For example, suppose that you search for the pattern `pattern` in the text of this paragraph. There are 191 characters up to the end of the first occurrence of the pattern, only 7 of which are the character `p` (and there are no occurrences of `pa`), so the total number of character compares is $191+7$, for an average of 1.036 compares per character in the text. On the other hand, there is no guarantee that the algorithm will always be so efficient. For example, a pattern might begin with a long string of `As`. If it does, and the text also has long strings of `As`, then the substring search will be slow.

<i>i</i>	<i>j</i>	<i>i+j</i>	0	1	2	3	4	5	6	7	8	9	10
			txt → A B A C A D A B R A C										
0	2	2	A	B	R	A	← pat						
1	0	1	A	B	R	A	entries in red are mismatches						
2	1	3	A	B	R	A	entries in gray are for reference only						
3	0	3	A	B	R	A	entries in black match the text						
4	1	5	A	B	R	A	A B R A						
5	0	5	A	B	R	A	A B R A						
6	4	10	A	B	R	A	A B R A						
										↑ match			

Brute-force substring search

Proposition M. Brute-force substring search requires $\sim NM$ character compares to search for a pattern of length M in a text of length N , in the worst case.

Proof: A worst-case input is when both pattern and text are all As followed by a B. Then for each of the $N - M + 1$ possible match positions, all the characters in the pattern are checked against the text, for a total cost of $M(N - M + 1)$. Normally M is very small compared to N , so the total is $\sim NM$.

Such degenerate strings are not likely to appear in English text, but they may well occur in other applications (for example, in binary texts), so we seek better algorithms.

<i>i</i>	<i>j</i>	<i>i+j</i>	0	1	2	3	4	5	6	7	8	9
			A	A	A	A	A	A	A	A	A	B
0	4	4	A	A	A	A	B					
1	4	5		A	A	A	A	B				
2	4	6			A	A	A	A	B			
3	4	7				A	A	A	A	B		
4	4	8					A	A	A	A	B	
5	5	10						A	A	A	A	B

Brute-force substring search (worst case)

The alternate implementation at the bottom of this page is instructive. As before, the program keeps one pointer (i) into the text and another pointer (j) into the pattern. As long as they point to matching characters, both pointers are incremented. This code performs precisely the same character compares as the previous implementation. To understand it,

note that i in this code maintains the value of $i+j$ in the previous code: it points to the *end* of the sequence of already-matched characters in the text (where i pointed to the *beginning* of the sequence before). If i and j point to mismatching characters, then we *back up* both pointers: j to point to the beginning of the pattern and i to correspond to moving the pattern to the right one position for matching against the text.

```
public static int search(String pat, String txt)
{
    int j, M = pat.length();
    int i, N = txt.length();
    for (i = 0, j = 0; i < N && j < M; i++)
    {
        if (txt.charAt(i) == pat.charAt(j)) j++;
        else { i -= j; j = 0; }
    }
    if (j == M) return i - M; // found
    else return N; // not found
}
```

Alternate implementation of brute-force substring search (explicit backup)

Knuth-Morris-Pratt substring search The basic idea behind the algorithm discovered by Knuth, Morris, and Pratt is this: whenever we detect a mismatch, we already know some of the characters in the text (since they matched the pattern characters prior to the mismatch). We can take advantage of this information to avoid backing up the text pointer over all those known characters.

As a specific example, suppose that we have a two-character alphabet and are searching for the pattern B A A A A A A A A. Now, suppose that we match five characters in the pattern, with a mismatch on the sixth. When the mismatch is detected,

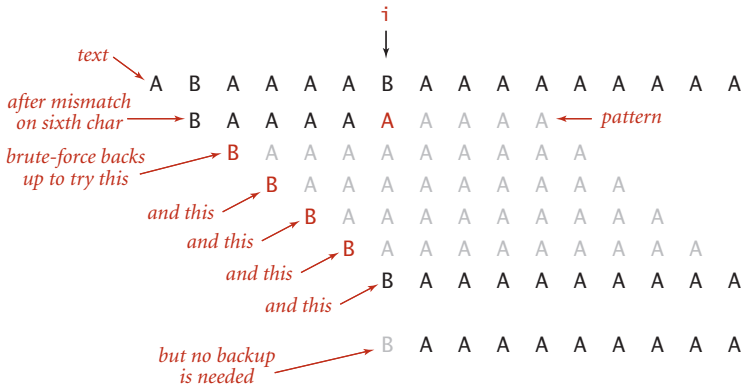

Text pointer backup in substring searching

i is a B and does match the first character in the pattern, so we can increment i and compare the next character in the text with the second character in the pattern. This argument leads to the observation that, for this pattern, we can change the `else` clause in the alternate brute-force implementation to just set $j = 1$ (and not decrement i). Since the value of i does not change within the loop, this method does at most N character compares. The practical effect of this particular change is limited to this particular pattern, but the idea is worth thinking about—the Knuth-Morris-Pratt algorithm is a generalization of it. Surprisingly, it is *always* possible to find a value to set the j pointer to on a mismatch, so that the i pointer is never decremented.

Fully skipping past all the matched characters when detecting a mismatch will not work when the pattern could match itself at any position overlapping the point of the mismatch. For example, when searching for the pattern A A B A A A in the text A A B A A B A A A A, we first detect the mismatch at position 5, but we had better restart at position 3 to continue the search, since otherwise we would miss the match. The insight of the KMP algorithm is that we can decide ahead of time exactly how to restart the search, because that decision depends only on the pattern.

we know that the six previous characters in the text must be B A A A A B (the first five match and the sixth does not), with the text pointer now pointing at the B at the end. The key observation is that we need not back up the text pointer i , since the previous four characters in the text are all As and do not match the first character in the pattern. Furthermore, the character currently pointed to by

Backing up the pattern pointer. In KMP substring search, we never back up the text pointer i , and we use an array $\text{dfa}[][]$ to record how far to back up the pattern pointer j when a mismatch is detected. For every character c , $\text{dfa}[c][j]$ is the pattern position to compare against the next text position after comparing c with $\text{pat.charAt}(j)$. During the search, $\text{dfa}[\text{txt.charAt}(i)][j]$ is the pattern position to compare with $\text{txt.charAt}(i+1)$ after comparing $\text{txt.charAt}(i)$ with $\text{pat.charAt}(j)$. For a match, we want to just move on to the next character, so $\text{dfa}[\text{pat.charAt}(j)][j]$ is always $j+1$. For a mismatch, we know not just $\text{txt.charAt}(i)$, but also the $j-1$ previous characters in the text: *they are the first $j-1$ characters in the pattern*. For each character c , imagine that we slide a copy of the pattern over these j characters (the first $j-1$ characters in the pattern followed by c —we are deciding what to do when these characters are $\text{txt.charAt}(i-j+1..i)$), from left to right, stopping when all overlapping characters match (or there are none). This gives the next possible place the pattern could match. The index of the pattern character to compare with $\text{txt.charAt}(i+1)$ ($\text{dfa}[\text{txt.charAt}(i)][j]$) is precisely the number of overlapping characters.

KMP search method. Once we have computed the $\text{dfa}[][]$ array, we have the substring search method at the top of the next page: when i and j point to mismatching characters (testing for a pattern match beginning at position $i-j+1$ in the text string), then the next possible position for a pattern match is beginning at position $i-\text{dfa}[\text{txt.charAt}(i)][j]$. But by construction, the first $\text{dfa}[\text{txt.charAt}(i)][j]$ characters at that position match the first $\text{dfa}[\text{txt.charAt}(i)][j]$ characters of the pattern, so there is no need to back up the i pointer: we can simply set j to $\text{dfa}[\text{txt.charAt}(i)][j]$ and increment i , which is precisely what we do when i and j point to matching characters.

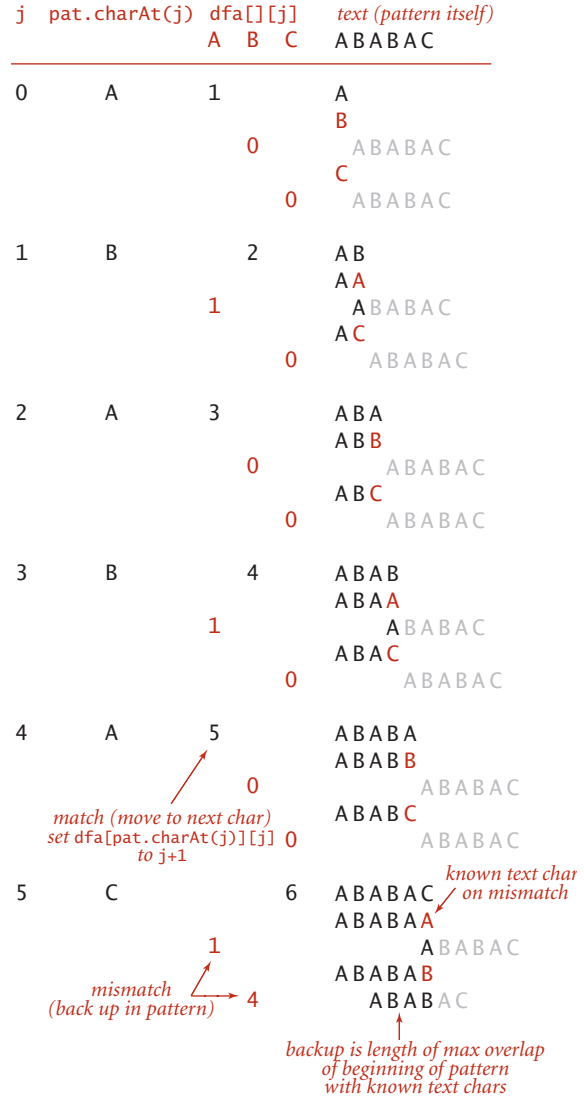

Pattern backup for ABABAC in KMP substring search

DFA simulation. A useful way to describe this process is in terms of a *deterministic finite-state automaton* (DFA). Indeed, as indicated by its name, our `dfa[][]` array precisely defines a DFA. The graphical DFA representation shown at the bottom of this page

```
public int search(String txt)
{ // Simulate operation of DFA on txt.
  int i, j, N = txt.length();
  for (i = 0, j = 0; i < N && j < M; i++)
    j = dfa[txt.charAt(i)][j];
  if (j == M) return i - M; // found
  else return N; // not found
}
```

KMP substring search (DFA simulation)

consists of states (indicated by circled numbers) and transitions (indicated by labeled lines). There is one state for each character in the pattern, each such state having one transition leaving it for each character in the alphabet. For the substring-matching DFAs that we are considering, one of the transitions is a *match* transition (going from `j` to `j+1` and labeled with `pat.charAt(j)`) and all the others are *mismatch* transition (going left). The states correspond to character compares, one for each value of the pattern index. The transitions correspond to changing the value of the pattern index. When examining the text character `i` when in the state labeled `j`, the machine does the following: “Take the transition to `dfa[txt.charAt(i)][j]` and move to the next character (by incrementing `i`).” For a match transition, we move to the right one position because `dfa[pat.charAt(j)][j]` is always `j+1`; for a mismatch transition we move to the left. The automaton reads the text characters one at a time, from left to right, moving to a new state each time it reads a character. We also include a *halt* state `M` that has no transitions. We start the machine at state 0: if the machine reaches state `M`, then a substring of the text matching the pattern has been found

(and we say that the DFA *recognizes* the pattern); if the machine reaches the end of the text before reaching state `M`, then we know the pattern does not appear as a substring of the text. Each pattern corresponds to an automaton (which is represented by the `dfa[][]` array that gives the transitions). The KMP substring search() method is a Java program that simulates the operation of such an automaton.

To get a feeling for the operation of a substring search DFA, consider two of the simplest things that it does. At

internal representation

j	0	1	2	3	4	5
pat.charAt(j)	A	B	A	B	A	C
dfa[][j]	A 1 1 3 1 5 1	B 0 2 0 4 0 4	C 0 0 0 0 0 6			

graphical representation

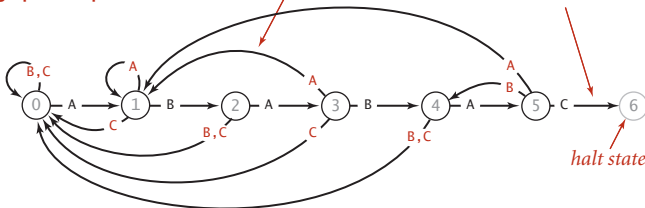

DFA corresponding to the string A B A B A C

The key observation is that the characters in the text that would need to be rescanned are precisely `pat.charAt(1)` through `pat.charAt(j-1)`: we drop the first character to shift right one position and the last character because of the mismatch. These are

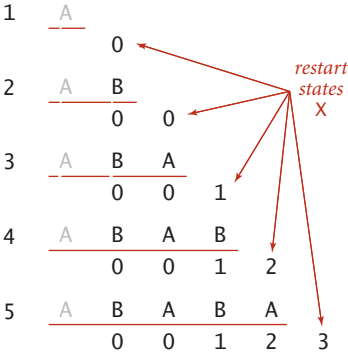

DFA simulations to compute restart states for A B A B A C

pattern characters that we know, so we can figure out ahead of time, for each possible mismatch position, the state where we need to restart the DFA. The figure at left shows the possibilities for our example. *Be sure that you understand this concept.*

What should the DFA do with the next character? Exactly what it should have done if we had backed up, *except* if it finds a match with `pat.charAt(j)`, when it should go to state `j+1`. For example, to decide what the DFA should do when we have a mismatch at `j = 5` for A B A B A C, we use the DFA to learn that a full backup would leave us in state 3 for B A B A, so we can copy `dfa[][3]` to `dfa[][5]`, then set the entry for C to 6 because `pat.charAt(5)` is C (a match). Since we only need to know how the DFA runs for `j-1` characters when we are building the `j`th state, we can always get the information that we need

from the partially built DFA.

The final crucial detail to the computation is to observe that maintaining the restart position `X` when working on column `j` of `dfa[][]` is easy because `X < j` so that we can use the partially built DFA to do the job—the next value of `X` is `dfa[pat.charAt(j)][X]`. Continuing our example from the previous paragraph, we would update the value of `X` to `dfa['C'][3] = 0` (but we do not use that value because the DFA construction is complete).

The discussion above leads to the remarkably compact code below for constructing the DFA corresponding to a given pattern. For each `j`, it

- Copies `dfa[][X]` to `dfa[][j]` (for mismatch cases)
- Sets `dfa[pat.charAt(j)][j]` to `j+1` (for the match case)
- Updates `X`

The diagram on the facing page traces this code for our example. To make sure that you understand it, work EXERCISE 5.3.2 and EXERCISE 5.3.3.

```
dfa[pat.charAt(0)][0] = 1;
for (int X = 0, j = 1; j < M; j++)
{ // Compute dfa[][j].
  for (int c = 0; c < R; c++)
    dfa[c][j] = dfa[c][X];
  dfa[pat.charAt(j)][j] = j+1;

  X = dfa[pat.charAt(j)][X];
}
```

Constructing the DFA for KMP substring search

j	0
pat.charAt(j)	A
dfa[][j]	A 1
	B 0
	C 0

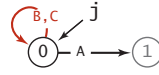

	X	
j	0	1
pat.charAt(j)	A	B
dfa[][j]	A 1	1
	B 0	2
	C 0	0

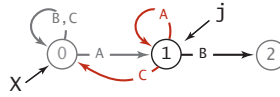

copy dfa[][X] to dfa[][j]
 dfa[pat.charAt(j)][j] = j+1;
 X = dfa[pat.charAt(j)][X];

	X		
j	0	1	2
pat.charAt(j)	A	B	A
dfa[][j]	A 1	1	3
	B 0	2	0
	C 0	0	0

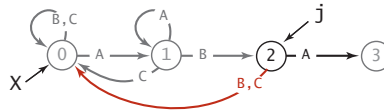

		X		
j	0	1	2	3
pat.charAt(j)	A	B	A	B
dfa[][j]	A 1	1	3	1
	B 0	2	0	4
	C 0	0	0	0

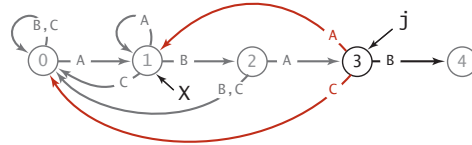

			X		
j	0	1	2	3	4
pat.charAt(j)	A	B	A	B	A
dfa[][j]	A 1	1	3	1	5
	B 0	2	0	4	0
	C 0	0	0	0	0

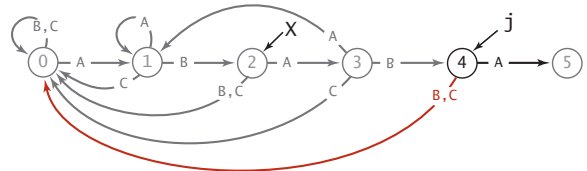

				X		
j	0	1	2	3	4	5
pat.charAt(j)	A	B	A	B	A	C
dfa[][j]	A 1	1	3	1	5	1
	B 0	2	0	4	0	4
	C 0	0	0	0	0	6

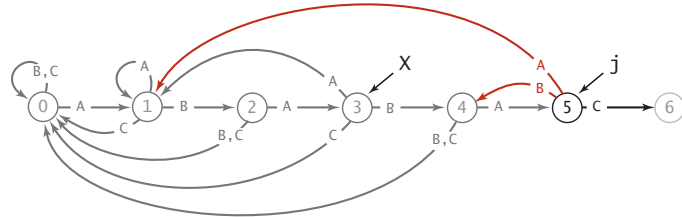

Constructing the DFA for KMP substring search for A B A B A C

ALGORITHM 5.6 Knuth-Morris-Pratt substring search

```

public class KMP
{
    private String pat;
    private int[][] dfa;

    public KMP(String pat)
    { // Build DFA from pattern.
        this.pat = pat;
        int M = pat.length();
        int R = 256;
        dfa = new int[R][M];
        dfa[pat.charAt(0)][0] = 1;
        for (int X = 0, j = 1; j < M; j++)
        { // Compute dfa[][j].
            for (int c = 0; c < R; c++)
                dfa[c][j] = dfa[c][X];           // Copy mismatch cases.
            dfa[pat.charAt(j)][j] = j+1;         // Set match case.
            X = dfa[pat.charAt(j)][X];           // Update restart state.
        }
    }

    public int search(String txt)
    { // Simulate operation of DFA on txt.
        int i, j, N = txt.length(), M = pat.length();
        for (i = 0, j = 0; i < N && j < M; i++)
            j = dfa[txt.charAt(i)][j];
        if (j == M) return i - M; // found (hit end of pattern)
        else return N; // not found (hit end of text)
    }

    public static void main(String[] args)
    // See page 769.
}

```

The constructor in this implementation of the Knuth-Morris-Pratt algorithm for substring search builds a DFA from a pattern string, to support a search() method that can find the pattern in a given text string. This program does the same job as the brute-force method, but it runs faster for patterns that are self-repetitive.

```

% java KMP AACAA AABRAACADABRAACAADABRA
text: AABRAACADABRAACAADABRA
pattern: AACAA

```

ALGORITHM 5.6 on the facing page implements the following API:

```
public class KMP
```

```
    KMP(String pat)           create a DFA that can search for pat
```

```
    int search(String txt)   find index of pat in txt
```

Substring search API

You can see a typical test client at the bottom of this page. The constructor builds a DFA from a pattern that the `search()` method uses to search for the pattern in a given text.

Proposition N. Knuth-Morris-Pratt substring search accesses no more than $M + N$ characters to search for a pattern of length M in a text of length N .

Proof. Immediate from the code: we access each pattern character once when computing `dfa[][]` and each text character once (in the worst case) in `search()`.

Another parameter comes into play: for an R -character alphabet, the total running time (and space) required to build the DFA is proportional to MR . It is possible to remove the factor of R by building a DFA where each state has a match transition and a mismatch transition (not transitions for each possible character), though the construction is somewhat more intricate.

The linear-time worst-case guarantee provided by the KMP algorithm is a significant theoretical result. In practice, the speedup over the brute-force method is not often important because few applications involve searching for highly self-repetitive patterns in highly self-repetitive text. Still, the method has the practical advantage that it never backs up in the input. This property makes KMP substring search more convenient for use on an input stream of undetermined length (such as standard input) than algorithms requiring backup, which need some complicated buffering in this situation. Ironically, when backup is easy, we can do significantly better than KMP. Next, we consider a method that generally leads to substantial performance gains precisely because it *can* back up in the text.

```
public static void main(String[] args)
{
    String pat = args[0];
    String txt = args[1];
    KMP kmp = new KMP(pat);
    StdOut.println("text:   " + txt);
    int offset = kmp.search(txt);
    StdOut.print("pattern: ");
    for (int i = 0; i < offset; i++)
        StdOut.print(" ");
    StdOut.println(pat);
}
```

KMP substring search test client

Starting point. To implement the mismatched character heuristic, we use an array `right[]` that gives, for each character in the alphabet, the index of its *rightmost occurrence* in the pattern (or `-1` if the character is not in the pattern). This value tells us precisely how far to skip if that character appears in the text and causes a mismatch during the string search. To initialize the `right[]` array, we set all entries to `-1` and then, for `j` from `0` to `M-1`, set `right[pat.charAt(j)]` to `j`, as shown in the example at right for our example pattern `NEEDLE`.

	N	E	E	D	L	E	
<u>c</u>	0	1	2	3	4	5	<u>right[c]</u>
A	-1	-1	-1	-1	-1	-1	-1
B	-1	-1	-1	-1	-1	-1	-1
C	-1	-1	-1	-1	-1	-1	-1
D	-1	-1	-1	-1	3	3	3
E	-1	-1	1	2	2	5	5
...							-1
L	-1	-1	-1	-1	-1	4	4
M	-1	-1	-1	-1	-1	-1	-1
N	-1	0	0	0	0	0	0
...							-1

Boyer-Moore skip table computation

Substring search. With the `right[]` array pre-computed, the implementation in ALGORITHM 5.7 is straightforward. We have an index `i` moving from left to right through the text and an index `j` moving from right to left through the pattern. The inner loop tests whether the pattern aligns with the text at position `i`. If `txt.charAt(i+j)` is equal to `pat.charAt(j)` for all `j` from `M-1` down to `0`, then there is a match. Otherwise, there is a character mismatch, and we have one of the following three cases:

- If the character causing the mismatch is not found in the pattern, we can slide the pattern `j+1` positions to the right (increment `i` by `j+1`). Anything less would align that character with some pattern character. Actually, this move aligns some known characters at the beginning of the pattern with known characters at the end of the pattern so that we could further increase `i` by precomputing a KMP-like table (see example at right).
- If the character `c` causing the mismatch is found in the pattern, we use the `right[]` array to line up the pattern with the text so that character will match its rightmost occurrence in the pattern. To do so, we increment `i` by `j` minus `right[c]`. Again, anything less would align that text character with a pattern character it could not match (one to the right of its rightmost occurrence). Again, there is a possibility that we could do better with a KMP-like table, as indicated in the top example in the figure on page 773.

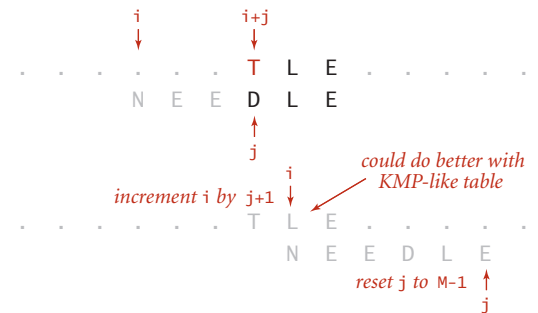

Mismatched character heuristic (mismatch not in pattern)

ALGORITHM 5.7 Boyer-Moore substring search (mismatched character heuristic)

```

public class BoyerMoore
{
    private int[] right;
    private String pat;

    BoyerMoore(String pat)
    { // Compute skip table.
        this.pat = pat;
        int M = pat.length();
        int R = 256;
        right = new int[R];
        for (int c = 0; c < R; c++)
            right[c] = -1; // -1 for chars not in pattern
        for (int j = 0; j < M; j++) // rightmost position for
            right[pat.charAt(j)] = j; // chars in pattern
    }

    public int search(String txt)
    { // Search for pattern in txt.
        int N = txt.length();
        int M = pat.length();
        int skip;
        for (int i = 0; i <= N-M; i += skip)
        { // Does the pattern match the text at position i ?
            skip = 0;
            for (int j = M-1; j >= 0; j--)
                if (pat.charAt(j) != txt.charAt(i+j))
                {
                    skip = j - right[txt.charAt(i+j)];
                    if (skip < 1) skip = 1;
                    break;
                }
            if (skip == 0) return i; // found.
        }
        return N; // not found.
    }

    public static void main(String[] args) // See page 769.
    }
}

```

The constructor in this substring search algorithm builds a table giving the rightmost occurrence in the pattern of each possible character. The search method scans from right to left in the pattern, skipping to align any character causing a mismatch with its rightmost occurrence in the pattern.

- If this computation would not increase i , we just increment i instead, to make sure that the pattern always slides at least one position to the right. The bottom example in the figure at right illustrates this situation.

ALGORITHM 5.7 is a straightforward implementation of this process. Note that the convention of using -1 in the `right[]` array entries corresponding to characters that do not appear in the pattern unifies the first two cases (increment i by $j - \text{right}[\text{txt.charAt}(i+j)]$).

The full Boyer-Moore algorithm takes into account precomputed mismatches of the pattern with itself (in a manner similar to the KMP algorithm) and provides a linear-time worst-case guarantee (whereas ALGORITHM 5.7 can take time proportional to NM in the worst case—see EXERCISE 5.3.19). We omit this computation because the mismatched character heuristic controls the performance in typical practical applications.

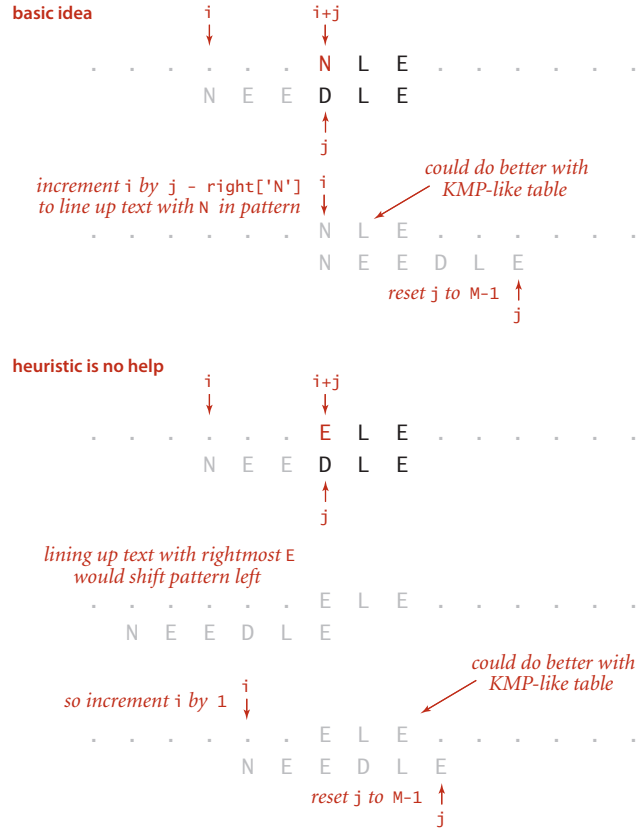

Mismatched character heuristic (mismatch in pattern)

Property O. On typical inputs, substring search with the Boyer-Moore mismatched character heuristic uses $\sim N/M$ character compares to search for a pattern of length M in a text of length N .

Discussion: This result can be proved for various random string models, but such models tend to be unrealistic, so we shall skip the details. In many practical situations it is true that all but a few of the alphabet characters appear nowhere in the pattern, so nearly all compares lead to M characters being skipped, which gives the stated result.

Rabin-Karp fingerprint search The method developed by M. O. Rabin and R. A. Karp is a completely different approach to substring search that is based on hashing. We compute a hash function for the pattern and then look for a match by using the same hash function for each possible M -character substring of the text. If we find a text substring with the same hash value as the pattern, we can check for a match. This process is equivalent to storing the pattern in a hash table, then doing a search for each substring of the text, but we do not need to reserve the memory for the hash table because it would have just one entry. A straightforward implementation based on this description would be much slower than a brute-force search (since computing a hash function that involves every character is likely to be much more expensive than just comparing characters), but Rabin and Karp showed that it is easy to compute hash functions for M -character substrings in *constant* time (after some preprocessing), which leads to a *linear*-time substring search in practical situations.

Basic plan. A string of length M corresponds to an M -digit base- R number. To use a hash table of size Q for keys of this type, we need a hash function to convert an M -digit base- R number to an `int` value between 0 and $Q-1$. Modular hashing (see SECTION 3.4) provides an answer: take the remainder when dividing the number by Q . In practice, we use a random prime Q , taking as large a value as possible while avoiding overflow (because we do not actually need to store a hash table). The method is simplest to understand for small Q and $R = 10$, shown in the example below. To find the pattern 2 6 5 3 5 in the text 3 1 4 1 5 9 2 6 5 3 5 8 9 7 9 3, we choose a table size Q (997 in the example), compute the hash value $26535 \% 997 = 613$, and then look for a match by computing hash values

	pat.charAt(j)					
j	0	1	2	3	4	
	2	6	5	3	5	% 997 = 613

	txt.charAt(i)																
i	0	1	2	3	4	5	6	7	8	9	10	11	12	13	14	15	
	3	1	4	1	5	9	2	6	5	3	5	8	9	7	9	3	
0	3	1	4	1	5	% 997 = 508											
1		1	4	1	5	9	% 997 = 201										
2			4	1	5	9	2	% 997 = 715									
3				1	5	9	2	6	% 997 = 971								
4					5	9	2	6	5	% 997 = 442							
5						9	2	6	5	3	% 997 = 929						
6	←	return i = 6						2	6	5	3	5	% 997 = 613				

Basis for Rabin-Karp substring search

for each five-digit substring in the text. In the example, we get the hash values 508, 201, 715, 971, 442, and 929 before finding the match 613.

Computing the hash function. With five-digit values, we could just do all the necessary calculations with `int` values, but what do we do when M is 100 or 1,000? A simple application of Horner's method, precisely like the method that we examined in SECTION 3.4 for strings and other types of keys with multiple values,

leads to the code shown at right, which computes the hash function for an M -digit base- R number represented as a char array in time proportional to M . (We pass M as an argument so that we can use the method for both the pattern and the text, as you will see.) For each digit in the number, we multiply by R , add the digit, and take the remainder when divided by Q . For example, computing the hash function for our pattern using this process is shown at the bottom of the page. The same method can work for computing the hash functions in the text, but the cost for the substring search would be a multiplication, addition, and remainder calculation for each text character, for a total of NM operations in the worst case, no improvement over the brute-force method.

```
private long hash(String key, int M)
{ // Compute hash for key[0..M-1].
  long h = 0;
  for (int j = 0; j < M; j++)
    h = (R * h + key.charAt(j)) % Q;
  return h;
}
```

Horner's method, applied to modular hashing

Key idea. The Rabin-Karp method is based on efficiently computing the hash function for position $i+1$ in the text, given its value for position i . It follows directly from a simple mathematical formulation. Using the notation t_i for `txt.charAt(i)`, the number corresponding to the M -character substring of `txt` that starts at position i is

$$x_i = t_i R^{M-1} + t_{i+1} R^{M-2} + \dots + t_{i+M-1} R^0$$

and we can assume that we know the value of $h(x_i) = x_i \bmod Q$. Shifting one position right in the text corresponds to replacing x_i by

$$x_{i+1} = (x_i - t_i R^{M-1}) R + t_{i+M}.$$

We subtract off the leading digit, multiply by R , then add the trailing digit. Now, the crucial point is that we do not have to maintain the values of the numbers, just the values of their remainders when divided by Q . A fundamental property of the modulus operation is that if we take the remainder when divided by Q after each arithmetic operation, then we get the same answer as if we were to perform all of the arithmetic operations, then take the remainder when divided by Q . We took advantage of this property once before, when implementing modular hashing with Horner's method (see page 460). The result is that we can effectively move right one position in the text in *constant* time, whether M is 5 or 100 or 1,000.

	i	0	1	2	3	4			
		2	6	5	3	5			
0	2	%	997	=	2				
1	2	6	%	997	=	(2*10 + 6) % 997	= 26		
2	2	6	5	%	997	=	(26*10 + 5) % 997 = 265		
3	2	6	5	3	%	997	=	(265*10 + 3) % 997 = 659	
4	2	6	5	3	5	%	997	=	(659*10 + 5) % 997 = 613

Computing the hash value for the pattern with Horner's method

ALGORITHM 5.8 Rabin-Karp fingerprint substring search

```

public class RabinKarp
{
    private String pat;           // pattern (only needed for Las Vegas)
    private long patHash;        // pattern hash value
    private int M;               // pattern length
    private long Q;              // a large prime
    private int R = 256;         // alphabet size
    private long RM;             //  $R^{M-1} \% Q$ 

    public RabinKarp(String pat)
    {
        this.pat = pat;         // save pattern (only needed for Las Vegas)
        this.M = pat.length();
        Q = longRandomPrime();  // See Exercise 5.3.33.
        RM = 1;
        for (int i = 1; i <= M-1; i++) // Compute  $R^{M-1} \% Q$  for use
            RM = (R * RM) % Q;        // in removing leading digit.
        patHash = hash(pat, M);
    }

    public boolean check(int i) // Monte Carlo (See text.)
    { return true; } // For Las Vegas, check pat vs txt(i..i-M+1).

    private long hash(String key, int M)
    // See text (page 775).
    private int search(String txt)
    { // Search for hash match in text.
        int N = txt.length();
        long txtHash = hash(txt, M);
        if (patHash == txtHash) return 0; // Match at beginning.
        for (int i = M; i < N; i++)
        { // Remove leading digit, add trailing digit, check for match.
            txtHash = (txtHash + Q - RM*txt.charAt(i-M) % Q) % Q;
            txtHash = (txtHash*R + txt.charAt(i)) % Q;
            if (patHash == txtHash)
                if (check(i - M + 1)) return i - M + 1; // match
        }
        return N; // no match found
    }
}

```

This substring search algorithm is based on hashing. It computes a hash value for the pattern in the constructor, then searches through the text looking for a hash match.

same value as our pattern less than 10^{-20} , an exceedingly small value. If that value is not small enough for you, you could run the algorithms again to get a probability of failure of less than 10^{-40} . This algorithm is an early and famous example of a *Monte Carlo* algorithm that has a guaranteed completion time but fails to output a correct answer with a small probability. The alternative method of checking for a match could be slow (it might amount to the brute-force algorithm, with a very small probability) but is guaranteed correct. Such an algorithm is known as a *Las Vegas* algorithm.

Property P. The Monte Carlo version of Rabin-Karp substring search is linear-time and extremely likely to be correct, and the Las Vegas version of Rabin-Karp substring search is correct and extremely likely to be linear-time.

Discussion: The use of the very large value of Q , made possible by the fact that we need not maintain an actual hash table, makes it extremely unlikely that a collision will occur. Rabin and Karp showed that when Q is properly chosen, we get a hash collision for random strings with probability $1/Q$, which implies that, for practical values of the variables, there are no hash matches when there are no substring matches and only one hash match if there is a substring match. Theoretically, a text position could lead to a hash collision and not a substring match, but in practice it can be relied upon to find a match.

If your belief in probability theory (or in the random string model and the code we use to generate random numbers) is more half-hearted than resolute, you can add to `check()` the code to check that the text matches the pattern, which turns ALGORITHM 5.8 into the Las Vegas version of the algorithm (see EXERCISE 5.3.12). If you also add a check to see whether that code is ever executed, you might develop more faith in probability theory as time wears on.

RABIN-KARP SUBSTRING SEARCH is known as a *fingerprint* search because it uses a small amount of information to represent a (potentially very large) pattern. Then it looks for this fingerprint (the hash value) in the text. The algorithm is efficient because the fingerprints can be efficiently computed and compared.

Summary The table at the bottom of the page summarizes the algorithms that we have discussed for substring search. As is often the case when we have several algorithms for the same task, each of them has attractive features. Brute-force search is easy to implement and works well in typical cases (Java's `indexOf()` method in `String` uses brute-force search); Knuth-Morris-Pratt is guaranteed linear-time with no backup in the input; Boyer-Moore is sublinear (by a factor of M) in typical situations; and Rabin-Karp is linear. Each also has drawbacks: brute-force might require time proportional to MN ; Knuth-Morris-Pratt and Boyer-Moore use extra space; and Rabin-Karp has a relatively long inner loop (several arithmetic operations, as opposed to character compares in the other methods). These characteristics are summarized in the table below.

algorithm	version	operation count		backup in input?	correct?	extra space
		guarantee	typical			
<i>brute force</i>	—	MN	$1.1 N$	yes	yes	1
<i>Knuth-Morris-Pratt</i>	<i>full DFA</i> (Algorithm 5.6)	$2N$	$1.1 N$	no	yes	MR
	<i>mismatch transitions only</i>	$3N$	$1.1 N$	no	yes	M
	<i>full algorithm</i>	$3N$	N / M	yes	yes	R
<i>Boyer-Moore</i>	<i>mismatched char heuristic only</i> (Algorithm 5.7)	MN	N / M	yes	yes	R
<i>Rabin-Karp</i> [†]	<i>Monte Carlo</i> (Algorithm 5.8)	$7N$	$7N$	no	yes [†]	1
	<i>Las Vegas</i>	$7N$ [†]	$7N$	yes	yes	1

[†] probabilistic guarantee, with uniform and independent hash function

Cost summary for substring search implementations

Q&A

Q. This substring search problem seems like a bit of a toy problem. Do I really need to understand these complicated algorithms?

A. Well, the factor of M speedup available with Boyer-Moore can be quite impressive in practice. Also, the ability to stream input (no backup) leads to many practical applications for KMP and Rabin-Karp. Beyond these direct practical applications, this topic provides an interesting introduction to the use of abstract machines and randomization in algorithm design.

Q. Why not simplify things by converting each character to binary, treating all text as binary text?

A. That idea is not quite effective because of false matches across character boundaries.

EXERCISES

- 5.3.1** Develop a brute-force substring search implementation `Brute`, using the same API as `ALGORITHM 5.6`.
- 5.3.2** Give the `dfa[][]` array for the Knuth-Morris-Pratt algorithm for the pattern `A A A A A A A A`, and draw the DFA, in the style of the figures in the text.
- 5.3.3** Give the `dfa[][]` array for the Knuth-Morris-Pratt algorithm for the pattern `A B R A C A D A B R A`, and draw the DFA, in the style of the figures in the text.
- 5.3.4** Write an efficient method that takes a string `txt` and an integer `M` as arguments and returns the position of the first occurrence of `M` consecutive blanks in the string, `txt.length` if there is no such occurrence. Estimate the number of character compares used by your method, on typical text and in the worst case.
- 5.3.5** Develop a brute-force substring search implementation `BruteForceRL` that processes the pattern from right to left (a simplified version of `ALGORITHM 5.7`).
- 5.3.6** Give the `right[]` array computed by the constructor in `ALGORITHM 5.7` for the pattern `A B R A C A D A B R A`.
- 5.3.7** Add to our brute-force implementation of substring search a `count()` method to count occurrences and a `searchAll()` method to print all occurrences.
- 5.3.8** Add to `KMP` a `count()` method to count occurrences and a `searchAll()` method to print all occurrences.
- 5.3.9** Add to `BoyerMoore` a `count()` method to count occurrences and a `searchAll()` method to print all occurrences.
- 5.3.10** Add to `RabinKarp` a `count()` method to count occurrences and a `searchAll()` method to print all occurrences.
- 5.3.11** Construct a worst-case example for the Boyer-Moore implementation in `ALGORITHM 5.7` (which demonstrates that it is not linear-time).
- 5.3.12** Add the code to `check()` in `RabinKarp` (`ALGORITHM 5.8`) that turns it into a Las Vegas algorithm (check that the pattern matches the text at the position given as argument).
- 5.3.13** In the Boyer-Moore implementation in `ALGORITHM 5.7`, show that you can set

EXERCISES *(continued)*

`right[c]` to the penultimate occurrence of `c` when `c` is the last character in the pattern.

5.3.14 Develop versions of the substring search implementations in this section that use `char[]` instead of `String` to represent the pattern and the text.

5.3.15 Design a brute-force substring search algorithm that scans the pattern from right to left.

5.3.16 Show the trace of the brute-force algorithm in the style of the figures in the text for the following pattern and text strings

- a. pattern: AAAAAAAB text: AAAAAAAAAAAAAAAAAAAAAAAB
- b. pattern: ABABABAB text: ABABABABAABABABABAAAAA

5.3.17 Draw the KMP DFA for the following pattern strings.

- a. AAAAAAB
- b. AACAAAB
- c. ABABABAB
- d. ABAABAAABAAAB
- e. ABAABCABAABCB

5.3.18 Suppose that the pattern and text are *random* strings over an alphabet of size R (which is at least 2). Show that the expected number of character compares for the brute-force method is $(N - M + 1) (1 - R^{-M}) / (1 - R^{-1}) \leq 2(N - M + 1)$.

5.3.19 Construct an example where the Boyer-Moore algorithm (with only the mismatched character heuristic) performs poorly.

5.3.20 How would you modify the Rabin-Karp algorithm to determine whether any of a subset of k patterns (say, all of the same length) is in the text?

Solution: Compute the hashes of the k patterns and store the hashes in a `StringSET` (see EXERCISE 5.2.6).

5.3.21 How would you modify the Rabin-Karp algorithm to search for a given pattern with the additional proviso that the middle character is a “wildcard” (any text character

at all can match it).

5.3.22 How would you modify the Rabin-Karp algorithm to search for an H -by- V pattern in an N -by- N text?

5.3.23 Write a program that reads characters one at a time and reports at each instant if the current string is a palindrome. *Hint*: Use the Rabin-Karp hashing idea.

CREATIVE PROBLEMS

5.3.24 *Find all occurrences.* Add a method `findAll()` to each of the four substring search algorithms given in the text that returns an `Iterable<Integer>` that allows clients to iterate through all offsets of the pattern in the text.

5.3.25 *Streaming.* Add a `search()` method to KMP that takes variable of type `In` as argument, and searches for the pattern in the specified input stream *without* using any extra instance variables. Then do the same for RabinKarp.

5.3.26 *Cyclic rotation check.* Write a program that, given two strings, determines whether one is a cyclic rotation of the other, such as `example` and `ampleex`.

5.3.27 *Tandem repeat search.* A tandem repeat of a base string `b` in a string `s` is a substring of `s` having at least two consecutive copies `b` (nonoverlapping). Develop and implement a linear-time algorithm that, given two strings `b` and `s`, returns the index of the beginning of the longest tandem repeat of `b` in `s`. For example, your program should return 3 when `b` is `abcab` and `s` is `abcabcababcababcababcab`.

5.3.28 *Buffering in brute-force search.* Add a `search()` method to your solution to EXERCISE 5.3.1 that takes an input stream (of type `In`) as argument and searches for the pattern in the given input stream. *Note:* You need to maintain a buffer that can keep at least the previous `M` characters in the input stream. Your challenge is to write efficient code to initialize, update, and clear the buffer for any input stream.

5.3.29 *Buffering in Boyer-Moore.* Add a `search()` method to ALGORITHM 5.7 that takes an input stream (of type `In`) as argument and searches for the pattern in the given input stream.

5.3.30 *Two-dimensional search.* Implement a version of the Rabin-Karp algorithm to search for patterns in two-dimensional text. Assume both pattern and text are rectangles of characters.

5.3.31 *Random patterns.* How many character compares are needed to do a substring search for a random pattern of length 100 in a given text?

Answer: None. The method

```
public boolean search(char[] txt)
{ return false; }
```

is quite effective for this problem, since the chances of a random pattern of length 100 appearing in any text are so low that you may consider it to be 0.

5.3.32 *Unique substrings.* Solve EXERCISE 5.2.14 using the idea behind the Rabin-Karp method.

5.3.33 *Random primes.* Implement `longRandomPrime()` for `RabinKarp` (ALGORITHM 5.8). *Hint:* A random n -digit number is prime with probability proportional to $1/n$.

5.3.34 *Straight-line code.* The Java Virtual Machine (and your computer’s assembly language) support a `goto` instruction so that the search can be “wired in” to machine code, like the program at right (which is exactly equivalent to simulating the DFA for the pattern as in `KMPdfa`, but likely to be much more efficient). To avoid checking whether the end of the text has been reached each time i is incremented, we assume that the pattern itself is stored at the end of the text as a sentinel, as the last M characters of the text. The `goto` labels in this code correspond precisely to the `dfa[]` array. Write a static method that takes a pattern as input and produces as output a straight-line program like this that searches for the pattern.

```

    int i = -1;
sm: i++;
s0: if (txt[i] != 'A' goto sm;
s1: if (txt[i] != 'A' goto s0;
s2: if (txt[i] != 'B' goto s0;
s3: if (txt[i] != 'A' goto s2;
s4: if (txt[i] != 'A' goto s0;
s5: if (txt[i] != 'A' goto s3;
    return i-8;

```

Straight-line substring search for A A B A A A

5.3.35 *Boyer-Moore in binary strings.* The mismatched character heuristic does not help much for binary strings, because there are only two possibilities for characters that cause the mismatch (and these are both likely to be in the pattern). Develop a substring search class for binary strings that groups bits together to make “characters” that can be used exactly as in ALGORITHM 5.7. *Note:* If you take b bits at a time, then you need a `right[]` array with 2^b entries. The value of b should be chosen small enough so that this table is not too large, but large enough that most b -bit sections of the text are not likely to be in the pattern—there are $M-b+1$ different b -bit sections in the pattern (one starting at each bit position from 1 through $M-b+1$), so we want $M-b+1$ to be significantly less than 2^b . For example, if you take 2^b to be about $\lg(4M)$, then the `right[]` array will be more than three-quarters filled with `-1` entries, but do not let b become less than $M/2$, since otherwise you could miss the pattern entirely, if it were split between two b -bit text sections.

EXPERIMENTS

5.3.36 *Random text.* Write a program that takes integers M and N as arguments, generates a random binary text string of length N , then counts the number of other occurrences of the last M bits elsewhere in the string. *Note:* Different methods may be appropriate for different values of M .

5.3.37 *KMP for random text.* Write a client that takes integers M , N , and T as input and runs the following experiment T times: Generate a random pattern of length M and a random text of length N , counting the number of character compares used by KMP to search for the pattern in the text. Instrument KMP to provide the number of compares, and print the average count for the T trials.

5.3.38 *Boyer-Moore for random text.* Answer the previous exercise for BoyerMoore.

5.3.39 *Timings.* Write a program that times the four methods for the task of searching for the substring

```
it is a far far better thing that i do than i have ever done
```

in the text of *Tale of Two Cities* (tale.txt). Discuss the extent to which your results validate the hypotheses about performance that are stated in the text.

This page intentionally left blank

5.4 REGULAR EXPRESSIONS

IN MANY APPLICATIONS, we need to do substring searching with somewhat less than complete information about the pattern to be found. A user of a text editor may wish to specify only part of a pattern, or to specify a pattern that could match a few different words, or to specify that any one of a number of patterns would do. A biologist might search for a genomic sequence satisfying certain conditions. In this section we will consider how pattern matching of this type can be done efficiently.

The algorithms in the previous section fundamentally depend on complete specification of the pattern, so we have to consider different methods. The basic mechanisms we will consider make possible a very powerful string-searching facility that can match complicated M -character patterns in N -character text strings in time proportional to MN in the worst case, and much faster for typical applications.

First, we need a way to describe the patterns: a rigorous way to specify the kinds of partial-substring-searching problems suggested above. This specification needs to involve more powerful primitive operations than the “check if the i th character of the text string matches the j th character of the pattern” operation used in the previous section. For this purpose, we use *regular expressions*, which describe patterns in combinations of three natural, basic, and powerful operations.

Programmers have used regular expressions for decades. With the explosive growth of search opportunities on the web, their use is becoming even more widespread. We will discuss a number of specific applications at the beginning of the section, not only to give you a feeling for their utility and power, but also to enable you to become more familiar with their basic properties.

As with the KMP algorithm in the previous section, we consider the three basic operations in terms of an abstract machine that can search for patterns in a text string. Then, as before, our pattern-matching algorithm will construct such a machine and then simulate its operation. Naturally, pattern-matching machines are typically more complicated than KMP DFAs, but not as complicated as you might expect.

As you will see, the solution we develop to the pattern-matching problem is intimately related to fundamental processes in computer science. For example, the method we will use in our program to perform the string-searching task implied by a given pattern description is akin to the method used by the Java system to transform a given Java program into a machine-language program for your computer. We also encounter the concept of *nondeterminism*, which plays a critical role in the search for efficient algorithms (see CHAPTER 6).

Describing patterns with regular expressions We focus on pattern descriptions made up of characters that serve as operands for three fundamental operations. In this context, we use the word *language* specifically to refer to a set of strings (possibly infinite) and the word *pattern* to refer to a language specification. The rules that we consider are quite analogous to familiar rules for specifying arithmetic expressions.

Concatenation. The first fundamental operation is the one used in the last section. When we write AB , we are specifying the language $\{AB\}$ that has one two-character string, formed by concatenating A and B .

Or. The second fundamental operation allows us to specify alternatives in the pattern. If we have an *or* between two alternatives, then both are in the language. We will use the vertical bar symbol $|$ to denote this operation. For example, $A|B$ specifies the language $\{A, B\}$ and $A|E|I|O|U$ specifies the language $\{A, E, I, O, U\}$. Concatenation has higher precedence than *or*, so $AB|BCD$ specifies the language $\{AB, BCD\}$.

Closure. The third fundamental operation allows parts of the pattern to be repeated arbitrarily. The *closure* of a pattern is the language of strings formed by concatenating the pattern with itself any number of times (including zero). We denote closure by placing a $*$ after the pattern to be repeated. Closure has higher precedence than concatenation, so AB^* specifies the language consisting of strings with an A followed by 0 or more B s, while A^*B specifies the language consisting of strings with 0 or more A s followed by a B . The *empty string*, which we denote by ϵ , is found in every text string (and in A^*).

Parentheses. We use parentheses to override the default precedence rules. For example, $C(AC|B)D$ specifies the language $\{CACD, CBD\}$; $(A|C)((B|C)D)$ specifies the language $\{ABD, CBD, ACD, CCD\}$; and $(AB)^*$ specifies the language of strings formed by concatenating any number of occurrences of AB , including no occurrences: $\{\epsilon, AB, ABAB, \dots\}$.

These simple rules allow us to write down REs that, while complicated, clearly and completely describe languages (see the table at right for a few examples).

Often, a language can be simply described in some other way, but discovering such a description can be a challenge. For example, the RE in the bottom row of the table specifies the subset of $(A|B)^*$ with an even number of B s.

RE	matches	does not match
$(A B)(C D)$	AC AD BC BD	every other string
$A(B C)^*D$	AD ABD ACD ABCCBD	BCD ADD ABCBC
$A^* (A^*BA^*BA^*)^*$	AAA BBAABB BABAAA	ABA BBB BABBAAA

Examples of regular expressions

REGULAR EXPRESSIONS ARE EXTREMELY SIMPLE formal objects, even simpler than the arithmetic expressions that you learned in grade school. Indeed, we will take advantage of their simplicity to develop compact and efficient algorithms for processing them. Our starting point will be the following formal definition:

Definition. A regular expression (RE) is either

- Empty
- A single character
- A regular expression enclosed in parentheses
- Two or more *concatenated* regular expressions
- Two or more regular expressions separated by the *or* operator (`|`)
- A regular expression followed by the *closure* operator (`*`)

This definition describes the *syntax* of regular expressions, telling us what constitutes a legal regular expression. The *semantics* that tells us the meaning of a given regular expression is the point of the informal descriptions that we have given in this section. For review, we summarize these by continuing the formal definition:

Definition (continued). Each RE represents a set of strings, defined as follows:

- The empty RE represents the *empty* set of strings, with 0 elements.
- A character represents the set of strings with one element, itself.
- An RE enclosed in parentheses represents the same set of strings as the RE without the parentheses.
- The RE consisting of two *concatenated* REs represents the *cross product* of the sets of strings represented by the individual components (all possible strings that can be formed by taking one string from each and concatenating them, in the same order as the REs).
- The RE consisting of the *or* of two REs represents the *union* of the sets represented by the individual components.
- The RE consisting of the *closure* of an RE represents ϵ (the empty string) or the union of the sets represented by the concatenation of any number of copies of the RE.

In general, the language described by a given RE might be very large, possibly infinite. There are many different ways to describe each language: we must try to specify succinct patterns just as we try to write compact programs and implement efficient algorithms.

Shortcuts Typical applications adopt various additions to these basic rules to enable us to develop succinct descriptions of languages of practical interest. From a theoretical standpoint, these are each simply a shortcut for a sequence of operations involving many operands; from a practical standpoint, they are a quite useful extension to the basic operations that enable us to develop compact patterns.

Set-of-characters descriptors. It is often convenient to be able to use a single character or a short sequence to directly specify sets of characters. The dot character (`.`) is a *wildcard* that represents any single character. A sequence of characters within square brackets represents any one of those characters. The sequence may also be specified as a range of characters. If preceded by a `^`, a sequence within square brackets represents any character *but* one of those characters. These notations are simply shortcuts for a sequence of *or* operations.

name	notation	example
<i>wildcard</i>	<code>.</code>	A.B
<i>specified set</i>	enclosed in <code>[]</code>	<code>[AEIOU]*</code>
<i>range</i>	enclosed in <code>[]</code> separated by <code>-</code>	<code>[A-Z]</code> <code>[0-9]</code>
<i>complement</i>	enclosed in <code>[]</code> preceded by <code>^</code>	<code>[^AEIOU]*</code>

Set-of-characters descriptors

Closure shortcuts. The closure operator specifies any number of copies of its operand. In practice, we want the flexibility to specify the number of copies, or a range on the number. In particular, we use the plus sign (`+`) to specify at least one copy, the question mark (`?`) to specify zero or one copy, and a count or a range within braces (`{}`) to specify a given number of copies. Again, these notations are shortcuts for a sequence of the basic concatenation, *or*, and closure operations.

Escape sequences. Some characters, such as `\`, `.`, `|`, `*`, `(`, and `)`, are *metacharacters* that we use to form regular expressions. We use *escape sequences* that begin with a backslash character `\` separating metacharacters from characters in the alphabet. An escape sequence may be a `\` followed by a single metacharacter (which represents that character). For example, `\\` represents `\`. Other escape sequences represent special characters and whitespace. For example, `\t` represents a tab character, `\n` represents a newline, and `\s` represents any whitespace character.

option	notation	example	shortcut for	in language	not in language
<i>at least 1</i>	<code>+</code>	<code>(AB)+</code>	<code>(AB)(AB)*</code>	AB ABABAB	<code>ε</code> BBBA
<i>0 or 1</i>	<code>?</code>	<code>(AB)?</code>	<code>ε</code> AB	<code>ε</code> AB	any other string
<i>specific</i>	count in <code>{}</code>	<code>(AB){3}</code>	<code>(AB)(AB)(AB)</code>	ABABAB	any other string
<i>range</i>	range in <code>{}</code>	<code>(AB){1-2}</code>	<code>(AB) (AB)(AB)</code>	AB ABAB	any other string

Closure shortcuts (for specifying the number of copies of the operand)

REs in applications REs have proven to be remarkably versatile in describing languages that are relevant in practical applications. Accordingly, REs are heavily used and have been heavily studied. To familiarize you with regular expressions while at the same time giving you some appreciation for their utility, we consider a number of practical applications before addressing the RE pattern-matching algorithm. REs also play an important role in theoretical computer science. Discussing this role to the extent it deserves is beyond the scope of this book, but we sometimes allude to relevant fundamental theoretical results.

Substring search. Our general goal is to develop an algorithm that determines whether a given text string is in the set of strings described by a given regular expression. If a text is in the language described by a pattern, we say that the text *matches* the pattern. Pattern matching with REs vastly generalizes the substring search problem of SECTION 5.3. Precisely, to search for a substring *pat* in a text string *txt* is to check whether *txt* is in the language described by the pattern `. * pat . *` or not.

Validity checking. You frequently encounter RE matching when you use the web. When you type in a date or an account number on a commercial website, the input-processing program has to check that your response is in the right format. One approach to performing such a check is to write code that checks all the cases: if you were to type in a dollar amount, the code might check that the first symbol is a \$, that the \$ is followed by a set of digits, and so forth. A better approach is to define an RE that describes the set of all legal inputs. Then, checking whether your input is legal is precisely the pattern-matching problem: is your input in the language described by the RE? Libraries of REs for common checks have sprung up on the web as this type of checking has come into widespread use. Typically, an RE is a much more precise and concise expression of the set of all valid strings than would be a program that checks all the cases.

context	regular expression	matches
<i>substring search</i>	<code>. * NEEDLE . *</code>	A HAYSTACK NEEDLE IN
<i>phone number</i>	<code>\([0-9]{3}\)\ [0-9]{3}-[0-9]{4}</code>	(800) 867-5309
<i>Java identifier</i>	<code>[\$_A-Za-z][\$_A-Za-z0-9]*</code>	Pattern_Matcher
<i>genome marker</i>	<code>gcg(cgg agg)*ctg</code>	gcgaggaggcgcgctg
<i>email address</i>	<code>[a-z]+@[a-z]+\.(edu com)</code>	rs@cs.princeton.edu

Typical regular expressions in applications (simplified versions)

Programmer's toolbox. The origin of regular expression pattern matching is the Unix command `grep`, which prints all lines matching a given RE. This capability has proven invaluable for generations of programmers, and REs are built into many modern programming systems, from `awk` and `emacs` to Perl, Python, and JavaScript. For example, suppose that you have a directory with dozens of `.java` files, and you want to know which of them has code that uses `StdIn`. The command

```
% grep StdIn *.java
```

will immediately give the answer. It prints all lines that match `.*StdIn.*` for each file.

Genomics. Biologists use REs to help address important scientific problems. For example, the human gene sequence has a region that can be described with the RE `gcg(cgg)*ctg`, where the number of repeats of the `cgg` pattern is highly variable among individuals, and a certain genetic disease that can cause mental retardation and other symptoms is known to be associated with a high number of repeats.

Search. Web search engines support REs, though not always in their full glory. Typically, if you want to specify alternatives with `|` or repetition with `*`, you can do so.

Possibilities. A first introduction to theoretical computer science is to think about the set of languages that can be specified with an RE. For example, you might be surprised to know that you can implement the modulus operation with an RE: for example, `(0 | 1(01*0)*1)*` describes all strings of 0s and 1s that are the binary representations of numbers that are multiples of three (!): `11`, `110`, `1001`, and `1100` are in the language, but `10`, `1011`, and `10000` are not.

Limitations. Not all languages can be specified with REs. A thought-provoking example is that no RE can describe the set of all strings that specify legal REs. Simpler versions of this example are that we cannot use REs to check whether parentheses are balanced or to check whether a string has an equal number of As and Bs.

THESE EXAMPLES JUST SCRATCH THE SURFACE. Suffice it to say that REs are a useful part of our computational infrastructure and have played an important role in our understanding of the nature of computation. As with KMP, the algorithm that we describe next is a byproduct of the search for that understanding.

Nondeterministic finite-state automata Recall that we can view the Knuth-Morris-Pratt algorithm as a finite-state machine constructed from the search pattern that scans the text. For regular expression pattern matching, we will generalize this idea.

The finite-state automaton for KMP changes from state to state by looking at a character from the text string and then changing to another state, depending on the character. The automaton reports a match if and only if it reaches the accept state. The algorithm itself is a simulation of the automaton. The characteristic of the machine that makes it easy to simulate is that it is *deterministic*: each state transition is completely determined by the next character in the text.

To handle regular expressions, we consider a more powerful abstract machine. Because of the *or* operation, the automaton cannot determine whether or not the pattern could occur at a given point by examining just one character; indeed, because of closure, it cannot even determine *how many* characters might need to be examined before a mismatch is discovered. To overcome these problems, we will endow the automaton with the power of *nondeterminism*: when faced with more than one way to try to match the pattern, the machine can “guess” the right one! This power might seem to you to be impossible to realize, but we will see that it is easy to write a program to build a *nondeterministic finite-state automaton* (NFA) and to efficiently simulate its operation. The overview of our RE pattern matching algorithm is the nearly the same as for KMP:

- Build the NFA corresponding to the given RE.
- Simulate the operation of that NFA on the given text.

Kleene’s Theorem, a fundamental result of theoretical computer science, asserts that there is an NFA corresponding to any given RE (and vice versa). We will consider a constructive proof of this fact that will demonstrate how to transform any RE into an NFA; then we simulate the operation of the NFA to complete the job.

Before we consider how to build pattern-matching NFAs, we will consider an example that illustrates their properties and the basic rules for operating them. Consider the figure below, which shows an NFA that determines whether a text string is in the language described by the RE $((A * B \mid A C) D)$. As illustrated in this example, the NFAs that we define have the following characteristics:

- The NFA corresponding to an RE of length M has exactly one state per pattern character, starts at state 0, and has a (virtual) accept state M .

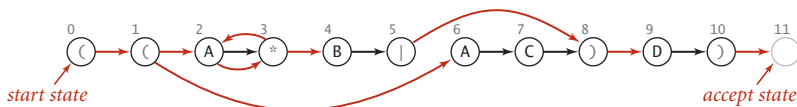

NFA corresponding to the pattern $((A * B \mid A C) D)$

- States corresponding to a character from the alphabet have an outgoing edge that goes to the state corresponding to the next character in the pattern (black edges in the diagram).
- States corresponding to the metacharacters (,) , | , and * have at least one outgoing edge (red edges in the diagram), which may go to any other state.
- Some states have multiple outgoing edges, but no state has more than one outgoing black edge.

By convention, we enclose all patterns in parentheses, so the first state corresponds to a left parenthesis and the final state corresponds to a right parenthesis (and has a transition to the accept state).

As with the DFAs of the previous section, we start the NFA at state 0, reading the first character of a text. The NFA moves from state to state, sometimes reading text characters, one at a time, from left to right. However, there are some basic differences from DFAs:

- Characters appear in the nodes, not the edges, in the diagrams.
- Our NFA recognizes a text string only after explicitly reading all its characters, whereas our DFA recognizes a pattern in a text without necessarily reading all the text characters.

These differences are not critical—we have picked the version of each machine that is best suited to the algorithms that we are studying.

Our focus now is on checking whether the text matches the pattern—for that, we need the machine to reach its accept state and consume all the text. The rules for moving from one state to another are also different than for DFAs—an NFA can do so in one of two ways:

- If the current state corresponds to a character in the alphabet *and* the current character in the text string matches the character, the automaton can scan past the character in the text string and take the (black) transition to the next state. We refer to such a transition as a *match transition*.
- The automaton can follow any red edge to another state without scanning any text character. We refer to such a transition as an ϵ -*transition*, referring to the idea that it corresponds to “matching” the empty string ϵ .

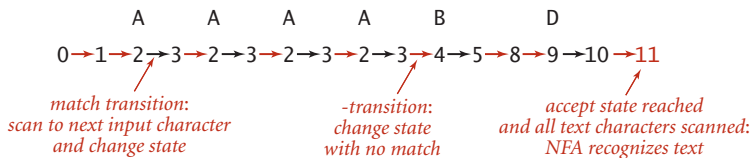

Finding a pattern with (A | A C) D) NFA

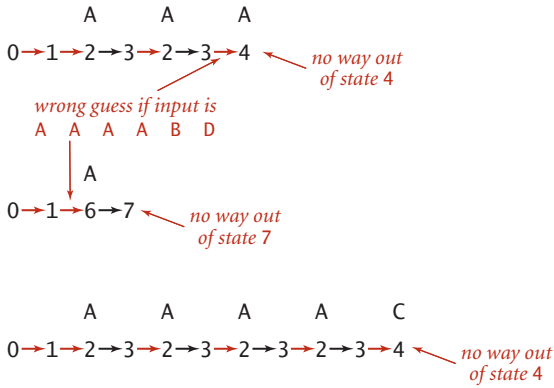

Stalling sequences for $(A^*B | AC)D$ NFA

For example, suppose that our NFA for $(A^*B | AC)D$ is started (at state 0) with the text `A A A A B D` as input. The figure at the bottom of the previous page shows a sequence of state transitions ending in the accept state. This sequence demonstrates that the text is in the set of strings described by the RE—the text *matches* the pattern. With respect to the NFA, we say that the NFA *recognizes* that text.

The examples shown at left illustrate that it is also possible to find transition sequences that cause the NFA to stall, even for input text such as `A A A A B D` that it should recognize. For example, if the NFA takes the transition to state

4 before scanning all the As, it is left with nowhere to go, since the only way out of state 4 is to match a B. These two examples demonstrate the nondeterministic nature of the automaton. After scanning an A and finding itself in state 3, the NFA has two choices: it could go on to state 4 or it could go back to state 2. The choices make the difference between getting to the accept state (as in the first example just discussed) or stalling (as in the second example just discussed). This NFA also has a choice to make at state 1 (whether to take an ϵ -transition to state 2 or to state 6).

These examples illustrate the key difference between NFAs and DFAs: since an NFA may have multiple edges leaving a given state, the transition from such a state is *not deterministic*—it might take one transition at one point in time and a different transition at a different point in time, without scanning past any text character. To make some sense of the operation of such an automaton, imagine that an NFA has the power to *guess* which transition (if any) will lead to the accept state for the given text string. In other words, we say that *an NFA recognizes a text string if and only if there is some sequence of transitions that scans all the text characters and ends in the accept state when started at the beginning of the text in state 0*. Conversely, an NFA does not recognize a text string if and only if there is no sequence of match transitions and ϵ -transitions that can scan all the text characters and lead to the accept state for that string.

As with DFAs, we have been tracing the operation of the NFA on a text string simply by listing the sequence of state changes, ending in the final state. Any such sequence is a proof that the machine recognizes the text string (there may be other proofs). But how do we find such a sequence for a given text string? And how do we prove that there is no such sequence for another given text string? The answers to these questions are easier than you might think: we systematically try all possibilities.

Simulating an NFA The idea of an automaton that can guess the state transitions it needs to get to the accept state is like writing a program that can guess the right answer to a problem: it seems ridiculous. On reflection, you will see that the task is conceptually not at all difficult: we make sure that we check all possible sequences of state transitions, so if there is one that gets to the accept state, we will find it.

Representation. To begin, we need an NFA representation. The choice is clear: the RE itself gives the state names (the integers between 0 and M , where M is the number of characters in the RE). We keep the RE itself in an array `re[]` of char values that defines the match transitions (if `re[i]` is in the alphabet, then there is a match transition from i to $i+1$). The natural representation for the ϵ -transitions is a *digraph*—they are directed edges (red edges in our diagrams) connecting vertices between 0 and M (one for each state). Accordingly, we represent all the ϵ -transitions as a digraph G . We will consider the task of building the digraph associated with a given RE after we consider the simulation process. For our example, the digraph consists of the nine edges

0 → 1 1 → 2 1 → 6 2 → 3 3 → 2 3 → 4 5 → 8 8 → 9 10 → 11

NFA simulation and reachability. To simulate an NFA, we keep track of the *set* of states that could possibly be encountered while the automaton is examining the current input character. The key computation is the familiar *multiple-source reachability* computation that we addressed in ALGORITHM 4.4 (page 571). To initialize this set, we find the set of states reachable via ϵ -transitions from state 0. For each such state, we check whether a match transition for the first input character is possible. This check gives us the set of possible states for the NFA just after matching the first input character. To this set, we add all states that could be reached via ϵ -transitions from one of the states in the set. Given the set of possible states for the NFA just after matching the first character in the input, the solution to the multiple-source reachability problem in the ϵ -transition digraph gives the set of states that could lead to match transitions for the *second* character in the input. For example, the initial set of states for our example NFA is 0 1 2 3 4 6; if the first character is an A, the NFA could take a match transition to 3 or 7; then it could take ϵ -transitions from 3 to 2 or 3 to 4, so the set of possible states that could lead to a match transition for the second character is 2 3 4 7. Iterating this process until all text characters are exhausted leads to one of two outcomes:

- The set of possible states contains the accept state.
- The set of possible states does not contain the accept state.

The first of these outcomes indicates that there is some sequence of transitions that takes the NFA to the accept state, so we report success. The second of these outcomes indicates that the NFA always stalls on that input, so we report failure. With our SET

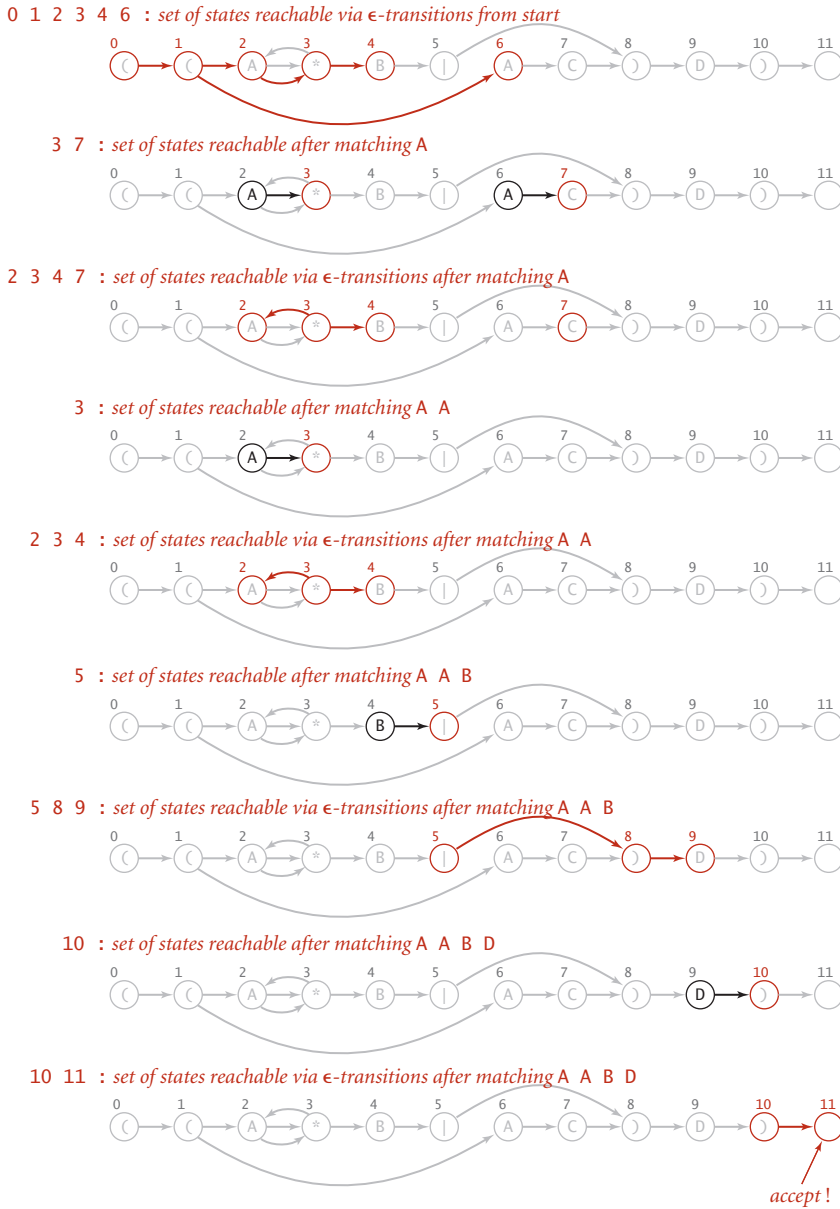

Simulation of $((A * B | A C) D)$ NFA for input A A B D

data type and the `DirectedDFS` class just described for computing multiple-source reachability in a digraph, the NFA simulation code given below is a straightforward translation of the English-language description just given. You can check your understanding of the code by following the trace on the facing page, which illustrates the full simulation for our example.

Proposition Q. Determining whether an N -character text string is recognized by the NFA corresponding to an M -character RE takes time proportional to NM in the worst case.

Proof: For each of the N text characters, we iterate through a set of states of size no more than M and run a DFS on the digraph of ϵ -transitions. The construction that we will consider next establishes that the number of edges in that digraph is no more than $2M$, so the worst-case time for each DFS is proportional to M .

Take a moment to reflect on this remarkable result. This worst-case cost, the product of the text and pattern lengths, is *the same* as the worst-case cost of finding an exact substring match using the elementary algorithm that we started with at the beginning of SECTION 5.3.

```
public boolean recognizes(String txt)
{ // Does the NFA recognize txt?
  Bag<Integer> pc = new Bag<Integer>();
  DirectedDFS dfs = new DirectedDFS(G, 0);
  for (int v = 0; v < G.V(); v++)
    if (dfs.marked(v)) pc.add(v);

  for (int i = 0; i < txt.length(); i++)
  { // Compute possible NFA states for txt[i+1].
    Bag<Integer> match = new Bag<Integer>();
    for (int v : pc)
      if (v < M)
        if (re[v] == txt.charAt(i) || re[v] == '.')
          match.add(v+1);
    pc = new Bag<Integer>();
    dfs = new DirectedDFS(G, match);
    for (int v = 0; v < G.V(); v++)
      if (dfs.marked(v)) pc.add(v);
  }

  for (int v : pc) if (v == M) return true;
  return false;
}
```

NFA simulation for pattern matching

Building an NFA corresponding to an RE From the similarity between regular expressions and familiar arithmetic expressions, you may not be surprised to find that translating an RE to an NFA is somewhat similar to the process of evaluating an arithmetic expression using Dijkstra’s two-stack algorithm, which we considered in SECTION 1.3. The process is a bit different because

- REs do not have an explicit operator for concatenation
- REs have a unary operator, for closure ($*$)
- REs have only one binary operator, for *or* ($|$)

Rather than dwell on the differences and similarities, we will consider an implementation that is tailored for REs. For example, we need only one stack, not two.

From the discussion of the representation at the beginning of the previous subsection, we need only build the digraph G that consists of all the ϵ -transitions. The RE itself and the formal definitions that we considered at the beginning of this section provide precisely the information that we need. Taking a cue from Dijkstra’s algorithm, we will use a stack to keep track of the positions of left parentheses and *or* operators.

Concatenation. In terms of the NFA, the concatenation operation is the simplest to implement. Match transitions for states corresponding to characters in the alphabet explicitly implement concatenation.

Parentheses. We push the RE index of each left parenthesis on the stack. Each time we encounter a right parenthesis, we eventually pop the corresponding left parentheses from the stack in the manner described below. As in Dijkstra’s algorithm, the stack enables us to handle nested parentheses in a natural manner.

Closure. A closure ($*$) operator must occur either (*i*) after a single character, when we add ϵ -transitions to and from the character, or (*ii*) after a right parenthesis, when we add ϵ -transitions to and from the corresponding left parenthesis, the one at the top of the stack.

Or expression. We process an RE of the form $(A | B)$ where A and B are both REs by adding two ϵ -transitions: one from the state corresponding to the left parenthesis to the state corresponding to the first character of B and one from the state corresponding to the $|$ operator to the state corresponding to the right parenthesis. We push the RE index corresponding the $|$ operator onto the stack (as well as the index corresponding to the left parenthesis, as described above) so that the information we need is at the top of the stack when needed, at the time we reach the right parenthesis. These ϵ -transitions allow the NFA to choose one of the two alternatives. We do not add an ϵ -transition from the state corresponding to the $|$ operator to the state with the next higher index, as we have for all other states—the only way for the NFA to leave such a state is to take a transition to the state corresponding to the right parenthesis.

THESE SIMPLE RULES SUFFICE TO build NFAs corresponding to arbitrarily complicated REs. ALGORITHM 5.9 is an implementation whose constructor builds the ϵ -transition digraph corresponding to a given RE, and a trace of the construction for our example appears on the following page. You can find other examples at the bottom of this page and in the exercises and are encouraged to enhance your understanding of the process by working your own examples. For brevity and for clarity, a few details (handling metacharacters, set-of-character descriptors, closure shortcuts, and multiway or operations) are left for exercises (see EXERCISES 5.4.16 through 5.4.21). Otherwise, the construction requires remarkably little code and represents one of the most ingenious algorithms that we have seen.

single-character closure

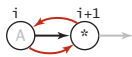

```
G.addEdge(i, i+1);
G.addEdge(i+1, i);
```

closure expression

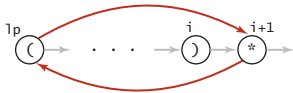

```
G.addEdge(lp, i+1);
G.addEdge(i+1, lp);
```

or expression

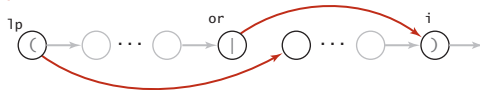

```
G.addEdge(lp, or+1);
G.addEdge(or, i);
```

NFA construction rules

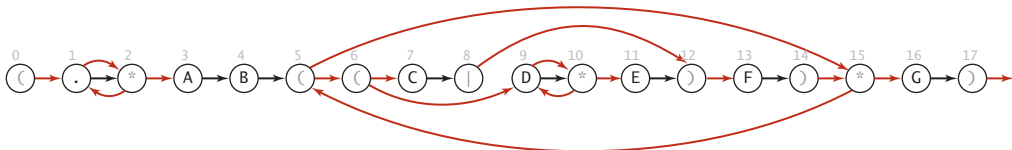

NFA corresponding to the pattern $(. * A B ((C | D * E) F) * G)$

ALGORITHM 5.9 Regular expression pattern matching (grep).

```

public class NFA
{
    private char[] re;           // match transitions
    private Digraph G;         // epsilon transitions
    private int M;             // number of states

    public NFA(String regexp)
    { // Create the NFA for the given regular expression.
        Stack<Integer> ops = new Stack<Integer>();
        re = regexp.toCharArray();
        M = re.length;
        G = new Digraph(M+1);

        for (int i = 0; i < M; i++)
        {
            int lp = i;
            if (re[i] == '(' || re[i] == '|')
                ops.push(i);
            else if (re[i] == ')')
            {
                int or = ops.pop();
                if (re[or] == '|')
                {
                    lp = ops.pop();
                    G.addEdge(lp, or+1);
                    G.addEdge(or, i);
                }
                else lp = or;
            }
            if (i < M-1 && re[i+1] == '*') // lookahead
            {
                G.addEdge(lp, i+1);
                G.addEdge(i+1, lp);
            }
            if (re[i] == '(' || re[i] == '*' || re[i] == ')')
                G.addEdge(i, i+1);
        }
    }

    public boolean recognizes(String txt)
    // Does the NFA recognize txt? (See page 799.)
}

```

This constructor builds an NFA corresponding to a given RE by creating a digraph of ϵ -transitions.

stack for indices of left parentheses and ops (ops)

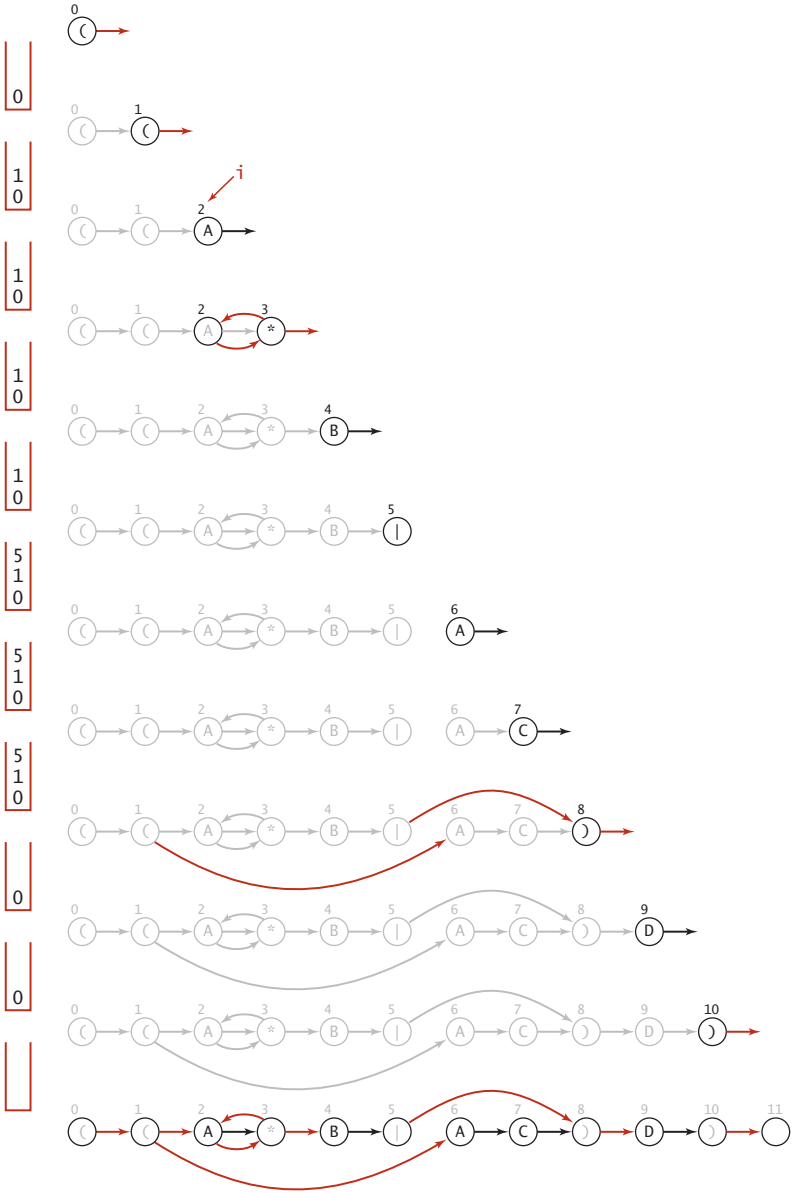

Building the NFA corresponding to $((A * B | A C) D)$

Proposition R. Building the NFA corresponding to an M -character RE takes time and space proportional to M in the worst case.

Proof. For each of the M RE characters in the regular expression, we add at most three ϵ -transitions and perhaps execute one or two stack operations.

The classic GREP client for pattern matching, illustrated in the code at left, takes an RE as argument and prints the lines from standard input having some *substring* that is

in the language described by the RE. This client was a feature in the early implementations of Unix and has been an indispensable tool for generations of programmers.

```
public class GREP
{
    public static void main(String[] args)
    {
        String regexp = "(.*" + args[0] + ".*)";
        NFA nfa = new NFA(regexp);
        while (StdIn.hasNextLine())
        {
            String txt = StdIn.hasNextLine();
            if (nfa.recognizes(txt))
                StdOut.println(txt);
        }
    }
}
```

Classic Generalized Regular Expression Pattern-matching NFA client

```
% more tinyL.txt
AC
AD
AAA
ABD
ADD
BCD
ABCCBD
BABAAA
BABBAAA

% java GREP "(A*B|AC)D" < tinyL.txt
ABD
ABCCBD

% java GREP StdIn < GREP.java
while (StdIn.hasNextLine())
    String txt = StdIn.hasNextLine();
```

Q&A

Q. What is the difference between *null* and ϵ ?

A. The former denotes an empty *set*; the latter denotes an empty *string*. You can have a set that contains one element, ϵ , and is therefore not *null*.

EXERCISES

5.4.1 Give regular expressions that describe all strings that contain

- Exactly four consecutive As
- No more than four consecutive As
- At least one occurrence of four consecutive As

5.4.2 Give a brief English description of each of the following REs:

- a. `.*`
- b. `A.*A | A`
- c. `.*ABBABBA.*`
- d. `.*A.*A.*A.*A.*`

5.4.3 What is the maximum number of different strings that can be described by a regular expression with *M* or operators and no closure operators (parentheses and concatenation are allowed)?

5.4.4 Draw the NFA corresponding to the pattern `((A|B)*|CD*|EFG)*`.

5.4.5 Draw the digraph of ϵ -transitions for the NFA from EXERCISE 5.4.4.

5.4.6 Give the sets of states reachable by your NFA from EXERCISE 5.4.4 after each character match and subsequent ϵ -transitions for the input `ABBACEFGCAAB`.

5.4.7 Modify the GREP client on page 804 to be a client `GREPmatch` that encloses the pattern in parentheses but does *not* add `.*` before and after the pattern, so that it prints out only those lines that are strings in the language described by the given RE. Give the result of typing each of the following commands:

- a. `% java GREPmatch "(A|B)(C|D)" < tinyL.txt`
- b. `% java GREPmatch "A(B|C)*D" < tinyL.txt`
- c. `% java GREPmatch "(A*B|AC)D" < tinyL.txt`

5.4.8 Write a regular expression for each of the following sets of binary strings:

- a. Contains at least three consecutive 1s
- b. Contains the substring 110
- c. Contains the substring 1101100
- d. Does not contain the substring 110

5.4.9 Write a regular expression for binary strings with at least two 0s but not consecutive 0s.

5.4.10 Write a regular expression for each of the following sets of binary strings:

- a. Has at least 3 characters, and the third character is 0
- b. Number of 0s is a multiple of 3
- c. Starts and ends with the same character
- d. Odd length
- e. Starts with 0 and has odd length, or starts with 1 and has even length
- f. Length is at least 1 and at most 3

5.4.11 For each of the following regular expressions, indicate how many bitstrings of length exactly 1,000 match:

- a. $0(0 \mid 1)^*1$
- b. 0^*101^*
- c. $(1 \mid 01)^*$

5.4.12 Write a Java regular expression for each of the following:

- a. Phone numbers, such as (609) 555-1234
- b. Social Security numbers, such as 123-45-6789
- c. Dates, such as December 31, 1999
- d. IP addresses of the form a.b.c.d where each letter can represent one, two, or three digits, such as 196.26.155.241
- e. License plates that start with four digits and end with two uppercase letters

CREATIVE PROBLEMS

5.4.13 *Challenging REs.* Construct an RE that describes each of the following sets of strings over the binary alphabet:

- a. All strings except 11 or 111
- b. Strings with 1 in every odd-number bit position
- c. Strings with at least two 0s and at most one 1
- d. Strings with no two consecutive 1s

5.4.14 *Binary divisibility.* Construct an RE that describes all binary strings that when interpreted as a binary number are

- a. Divisible by 2
- b. Divisible by 3
- c. Divisible by 123

5.4.15 *One-level REs.* Construct a Java RE that describes the set of strings that are legal REs over the binary alphabet, but with no occurrence of parentheses within parentheses. For example, $(0.*1)^*$ or $(1.*0)^*$ is in this language, but $(1(0 \text{ or } 1)1)^*$ is not.

5.4.16 *Multiway or.* Add multiway or to NFA. Your code should produce the machine drawn below for the pattern $(.*AB((C|D|E)F)^*G)$.

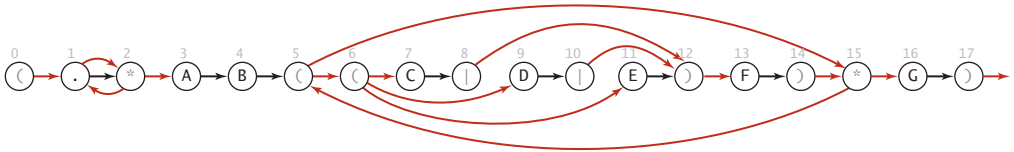

NFA corresponding to the pattern $(.*AB((C|D|E)F)^*G)$

- 5.4.17** *Wildcard.* Add to NFA the capability to handle wildcards.
- 5.4.18** *One or more.* Add to NFA the capability to handle the + closure operator.
- 5.4.19** *Specified set.* Add to NFA the capability to handle specified-set descriptors.
- 5.4.20** *Range.* Add to NFA the capability to handle range descriptors.
- 5.4.21** *Complement.* Add to NFA the capability to handle complement descriptors.
- 5.4.22** *Proof.* Develop a version of NFA that prints a *proof* that a given string is in the language recognized by the NFA (a sequence of state transitions that ends in the accept state).



5.5 DATA COMPRESSION

The world is awash with data, and algorithms designed to represent data efficiently play an important role in the modern computational infrastructure. There are two primary reasons to compress data: to save storage when saving information and to save time when communicating information. Both of these reasons have remained important through many generations of technology and are familiar today to anyone needing a new storage device or waiting for a long download.

You have certainly encountered compression when working with digital images, sound, movies, and all sorts of other data. The algorithms we will examine save space by exploiting the fact that most data files have a great deal of redundancy: For example, text files have certain character sequences that appear much more often than others; bitmap files that encode pictures have large homogeneous areas; and files for the digital representation of images, movies, sound, and other analog signals have large repeated patterns.

We will look at an elementary algorithm and two advanced methods that are widely used. The compression achieved by these methods varies depending on characteristics of the input. Savings of 20 to 50 percent are typical for text, and savings of 50 to 90 percent might be achieved in some situations. As you will see, the effectiveness of any data compression method is quite dependent on characteristics of the input. *Note:* Usually, in this book, we are referring to time when we speak of performance; with data compression we normally are referring to the compression they can achieve, although we will also pay attention to the time required to do the job.

On the one hand, data-compression techniques are less important than they once were because the cost of computer storage devices has dropped dramatically and far more storage is available to the typical user than in the past. On the other hand, data-compression techniques are more important than ever because, since so much storage is in use, the savings they make possible are greater. Indeed, data compression has come into widespread use with the emergence of the internet, because it is a low-cost way to reduce the time required to transmit large amounts of data.

Data compression has a rich history (we will only be providing a brief introduction to the topic), and contemplating its role in the future is certainly worthwhile. Every student of algorithms can benefit from studying data compression because the algorithms are classic, elegant, interesting, and effective.

Rules of the game All of the types of data that we process with modern computer systems have something in common: *they are ultimately represented in binary*. We can consider each of them to be simply a sequence of bits (or bytes). For brevity, we use the term *bitstream* in this section to refer to a sequence of bits and *bytestream* when we are referring to the bits being considered as a sequence of fixed-size bytes. A bitstream or a bytestream might be stored as a file on your computer, or it might be a message being transmitted on the internet.

Basic model. Accordingly, our basic model for data compression is quite simple, having two primary components, each a black box that reads and writes bitstreams:

- A *compress* box that transforms a bitstream B into a compressed version $C(B)$
- An *expand* box that transforms $C(B)$ back into B

Using the notation $|B|$ to denote the number of bits in a bitstream, we are interested in minimizing the quantity $|C(B)| / |B|$, which is known as the *compression ratio*.



Basic model for data compression

This model is known as *lossless compression*—we insist that no information be lost, in the specific sense that the result of compressing and expanding a bitstream must match the original, bit for bit. Lossless compression is required for many types of files, such as numerical data or executable code. For some types of files (such as images, videos, or music), it is reasonable to consider compression methods that are allowed to lose some information, so the decoder only produces an approximation of the original file. Lossy methods have to be evaluated in terms of a subjective quality standard in addition to the compression ratio. We do not address lossy compression in this book.

Reading and writing binary data A full description of how information is encoded on your computer is system-dependent and is beyond our scope, but with a few basic assumptions and two simple APIs, we can separate our implementations from these details. These APIs, `BinaryStdIn` and `BinaryStdOut`, are modeled on the `StdIn` and `StdOut` APIs that you have been using, but their purpose is to read and write *bits*, where `StdIn` and `StdOut` are oriented toward *character streams* encoded in Unicode. An `int` value on `StdOut` is a sequence of characters (its decimal representation); an `int` value on `BinaryStdOut` is a sequence of bits (its binary representation).

Binary input and output. Most systems nowadays, including Java, base their I/O on 8-bit bytestreams, so we might decide to read and write bytestreams to match I/O formats with the internal representations of primitive types, encoding an 8-bit char with 1 byte, a 16-bit short with 2 bytes, a 32-bit int with 4 bytes, and so forth. Since *bitstreams* are the primary abstraction for data compression, we go a bit further to allow clients to read and write individual *bits*, intermixed with data of primitive types. The goal is to minimize the necessity for type conversion in client programs and also to take care of operating system conventions for representing data. We use the following API for reading a bitstream from standard input:

```
public class BinaryStdIn
```

```
boolean readBoolean()    read 1 bit of data and return as a boolean value
```

```
char readChar()         read 8 bits of data and return as a char value
```

```
char readChar(int r)    read r (between 1 and 16) bits of data  
and return as a char value
```

[similar methods for byte (8 bits); short (16 bits); int (32 bits); long and double (64 bits)]

```
boolean isEmpty()       is the bitstream empty?
```

```
void close()           close the bitstream
```

API for static methods that read from a bitstream on standard input

A key feature of the abstraction is that, in marked contrast to StdIn, *the data on standard input is not necessarily aligned on byte boundaries*. If the input stream is a single byte, a client could read it 1 bit at a time with eight calls to readBoolean(). The close() method is not essential, but, for clean termination, clients should call close() to indicate that no more bits are to be read. As with StdIn/StdOut, we use the following complementary API for writing bitstreams to standard output:

```
public class BinaryStdOut
```

```
void write(boolean b)   write the specified bit
```

```
void write(char c)     write the specified 8-bit char
```

```
void write(char c, int r) write the r (between 1 and 16) least significant bits  
of the specified char
```

[similar methods for byte (8 bits); short (16 bits); int (32 bits); long and double (64 bits)]

```
void close()           close the bitstream
```

API for static methods that write to a bitstream on standard output

For output, the `close()` method is essential: clients must call `close()` to ensure that all of the bits specified in prior `write()` calls make it to the bitstream and that the final byte is padded with 0s to byte-align the output for compatibility with the file system. As with the `In` and `Out` APIs associated with `StdIn` and `StdOut`, we also have available `BinaryIn` and `BinaryOut` that allows us to reference binary-encoded files directly.

Example. As a simple example, suppose that you have a data type where a date is represented as three `int` values (month, day, year). Using `StdOut` to write those values in the format `12/31/1999` requires 10 characters, or 80 bits. If you write the values directly with `BinaryStdOut`, you would produce 96 bits (32 bits for each of the 3 `int` values); if you use a more economical representation that uses `byte` values for the month and day and a `short` value for the year, you would produce 32 bits. With `BinaryStdOut` you could also write a 4-bit field, a 5-bit field, and a 12-bit field, for a total of 21 bits (24 bits, actually, because files must be an integral number of 8-bit bytes, so `close()` adds three 0 bits at the end). *Important note:* Such economy, in itself, is a crude form of data compression.

Binary dumps. How can we examine the contents of a bitstream or a bytestream while debugging? This question faced early programmers when the only way to find a bug was to examine each of the bits in memory, and the term *dump* has been used since the early days of computing to describe a human-readable view of a bitstream. If you try to open

a character stream (`StdOut`)

```
StdOut.print(month + "/" + day + "/" + year);
```

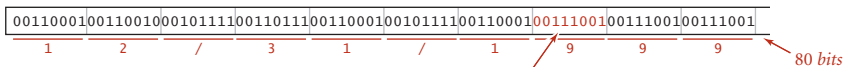

three ints (`BinaryStdOut`)

```
BinaryStdOut.write(month);
BinaryStdOut.write(day);
BinaryStdOut.write(year);
```

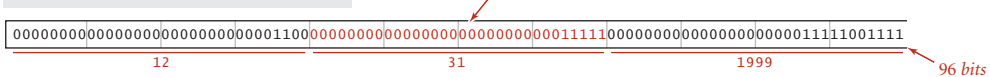

two chars and a short (`BinaryStdOut`)

```
BinaryStdOut.write((char) month);
BinaryStdOut.write((char) day);
BinaryStdOut.write((short) year);
```

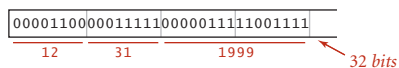

a 4-bit field, a 5-bit field, and a 12-bit field (`BinaryStdOut`)

```
BinaryStdOut.write(month, 4);
BinaryStdOut.write(day, 5);
BinaryStdOut.write(year, 12);
```

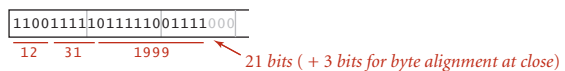

Four ways to put a date onto standard output

```

public class BinaryDump
{
    public static void main(String[] args)
    {
        int width = Integer.parseInt(args[0]);
        int cnt;
        for (cnt = 0; !BinaryStdIn.isEmpty(); cnt++)
        {
            if (width == 0) continue;
            if (cnt != 0 && cnt % width == 0)
                StdOut.println();
            if (BinaryStdIn.readBoolean())
                StdOut.print("1");
            else StdOut.print("0");
        }
        StdOut.println();
        StdOut.println(cnt + " bits");
    }
}

```

Printing a bitstream on standard (character) output

a file with an editor or view it in the manner in which you view text files (or just run a program that uses `BinaryStdOut`), you are likely to see gibberish, depending on the system you use. `BinaryStdIn` allows us to avoid such system dependencies by writing our own programs to convert bitstreams such that we can see them with our standard tools. For example, the program `BinaryDump` at left is a `BinaryStdIn` client that prints out the bits from standard input, encoded with the characters 0 and 1. This program is useful for debugging when working with small inputs. The similar client

`HexDump` groups the data into 8-bit bytes and prints each as two hexadecimal digits that each represent 4 bits. The client `PictureDump` displays the bits in a `Picture` with 0 bits represented as white pixels and 1 bits represented as black pixels. This pictorial representation is often useful in identifying patterns in a bitstream. You can download `BinaryDump`, `HexDump`, and `PictureDump` from the booksite. Typically, we use piping and redirection at the command-line level when working with binary files: we can pipe the output of an encoder to `BinaryDump`, `HexDump`, or `PictureDump`, or redirect it to a file.

standard character stream

```
% more abra.txt
ABRACADABRA!
```

bitstream represented as 0 and 1 characters

```
% java BinaryDump 16 < abra.txt
0100000101000010
0101001001000001
0100001101000001
0100010001000001
0100001001010010
0100000100100001
96 bits
```

bitstream represented with hex digits

```
% java HexDump 4 < abra.txt
41 42 52 41
43 41 44 41
42 52 41 21
96 bits
```

bitstream represented as pixels in a Picture

```
% java PictureDump 16 6 < abra.txt
```



96 bits

Four ways to look at a bitstream

ASCII encoding. When you HexDump a bit-stream that contains ASCII-encoded characters, the table at right is useful for reference. Given a two digit hex number, use the first hex digit as a row index and the second hex digit as a column index to find the character that it encodes. For example, 31 encodes the digit 1, 4A encodes the letter J, and so forth. This table is for 7-bit ASCII, so the first hex digit must be 7 or less. Hex numbers starting with 0 and 1 (and the numbers 20 and 7F) correspond to non-printing control characters. Many of the control characters are left over from the days when physical devices such as typewriters were controlled by ASCII input; the table highlights a few that you might see in dumps. For example, SP is the space character, NUL is the null character, LF is line feed, and CR is carriage return.

	0	1	2	3	4	5	6	7	8	9	A	B	C	D	E	F
0	NUL	SOH	STX	ETX	EOT	ENQ	ACK	BEL	BS	HT	LF	VT	FF	CR	SO	SI
1	DLE	DC1	DC2	DC3	DC4	NAK	SYN	ETB	CAN	EM	SUB	ESC	FS	GS	RS	US
2	SP	!	"	#	\$	%	&	'	()	*	+	,	-	.	/
3	0	1	2	3	4	5	6	7	8	9	:	;	<	=	>	?
4	@	A	B	C	D	E	F	G	H	I	J	K	L	M	N	O
5	P	Q	R	S	T	U	V	W	X	Y	Z	[\]	^	_
6	`	a	b	c	d	e	f	g	h	i	j	k	l	m	n	o
7	p	q	r	s	t	u	v	w	x	y	z	{		}	~	DEL

Hexadecimal-to-ASCII conversion table

IN SUMMARY, working with data compression requires us to reorient our thinking about standard input and standard output to include binary encoding of data. `BinaryStdIn` and `BinaryStdOut` provide the methods that we need. They provide a way for you to make a clear distinction in your client programs between writing out information intended for file storage and data transmission (that will be read by programs) and printing information (that is likely to be read by humans).

Limitations To appreciate data-compression algorithms, you need to understand fundamental limitations. Researchers have developed a thorough and important theoretical basis for this purpose, which we will consider briefly at the end of this section, but a few ideas will help us get started.

Universal data compression. Armed with the algorithmic tools that have proven so useful for so many problems, you might think that our goal should be *universal data compression*: an algorithm that can make any bitstream smaller. Quite to the contrary, we have to adopt more modest goals because universal data compression is impossible.

Proposition 5. No algorithm can compress every bitstream.

Proof: We consider two proofs that each provide some insight. The first is by contradiction: Suppose that you have an algorithm that does compress every bitstream. Then you could use that algorithm to compress its output to get a still shorter bitstream, and continue until you have a bitstream of length 0! The conclusion that your algorithm compresses every bitstream to 0 bits is absurd, and so is the assumption that it can compress every bitstream.

The second proof is a counting argument. Suppose that you have an algorithm that claims lossless compression for every 1,000-bit stream. That is, every such stream must map to a different shorter one. But there are only $1 + 2 + 4 + \dots + 2^{998} + 2^{999} = 2^{1000} - 1$ bitstreams with fewer than 1,000 bits and 2^{1000} bitstreams with 1,000 bits, so your algorithm cannot compress all of them. This argument becomes more persuasive if we consider stronger claims. Say your goal is to achieve better than a 50 percent compression ratio. You have to know that you will be successful for only about 1 out of 2^{500} of the 1,000-bit bitstreams!

Put another way, you have at most a 1 in 2^{500} chance of being able to compress by half a random 1,000-bit stream with any data-compression algorithm. When you run across a new lossless compression algorithm, it is a sure bet that it will not achieve significant compression for a random bitstream. The insight that we cannot hope to compress random streams is a start to understanding data compression. We regularly process strings of millions or billions of bits but will never process even the tiniest fraction of all possible such strings, so we need

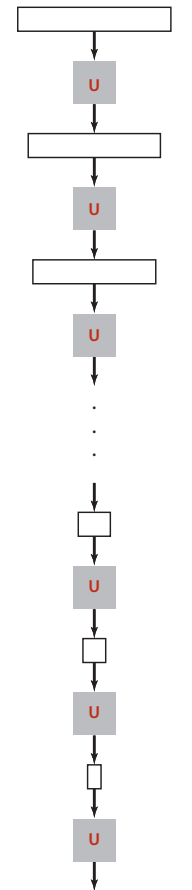

Universal
data compression?

```
% java RandomBits | java PictureDump 2000 500
```

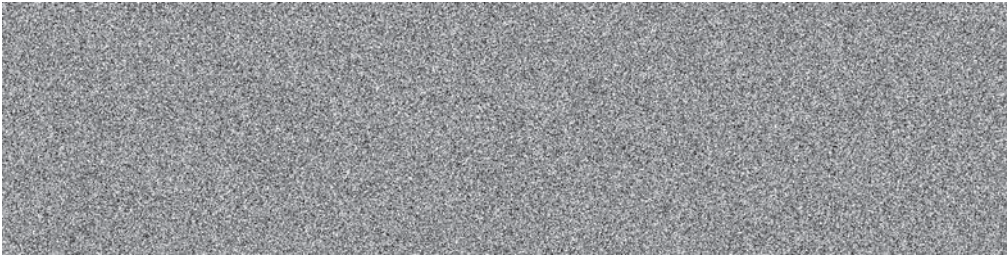

1000000 bits

A difficult file to compress: 1 million (pseudo-) random bits

not be discouraged by this theoretical result. Indeed, the bitstrings that we regularly process are typically highly structured, a fact that we can exploit for compression.

Undecidability. Consider the million-bit string pictured at the top of this page. This string appears to be random, so you are not likely to find a lossless compression algorithm that will compress it. But there is a way to represent that string with just a few thousand bits, because it was produced by the program below. (This program is an example of a pseudo-random number generator, like Java's `Math.random()` method.) A compression algorithm that compresses by writing the program in ASCII and expands by reading the program and then running it achieves a .3 percent compression ratio, which is difficult to beat (and we can drive the ratio arbitrarily low by writing more bits). To compress such a file is to discover the program that produced it. This example is not so far-fetched as it first appears: when you compress a video or an old book that was digitized with a scanner or any of countless other types of files from the web, you are discovering something about the program that produced the file. The realization that much of the data that we process is produced by a program leads to deep issues in the theory of computation and also gives insight into the challenges of data compression. For example, it is possible to prove that optimal data compression (find the shortest program to produce a given string) is an *undecidable* problem: not only can we not have an algorithm that compresses every bitstream, but also we cannot have a strategy for developing the best algorithm!

```
public class RandomBits
{
    public static void main(String[] args)
    {
        int x = 11111;
        for (int i = 0; i < 1000000; i++)
        {
            x = x * 314159 + 218281;
            BinaryStdOut.write(x > 0);
        }
        BinaryStdOut.close();
    }
}
```

A "compressed" million-bit stream

The practical impact of these limitations is that lossless compression methods must be oriented toward taking advantage of *known* structure in the bitstreams to be compressed. The four methods that we consider exploit, in turn, the following structural characteristics:

- Small alphabets
- Long sequences of identical bits/characters
- Frequently used characters
- Long reused bit/character sequences

If you know that a given bitstream exhibits one or more of these characteristics, you can compress it with one of the methods that you are about to learn; if not, trying them each is probably still worth the effort, since the underlying structure of your data may not be obvious, and these methods are widely applicable. As you will see, each method has parameters and variations that may need to be tuned for best compression of a particular bitstream. The first and last recourse is to learn something about the structure of your data yourself and exploit that knowledge to compress it, perhaps using one of the techniques we are about to consider.

Warmup: genomics As preparation for more complicated data-compression algorithms, we now consider an elementary (but very important) data-compression task. All of our implementations will use the same conventions that we will now introduce in the context of this example.

Genomic data. As a first example of data compression, consider this string:

ATAGATGCATAGCGCATAGCTAGATGTGCTAGCAT

Using standard ASCII encoding (1 byte, or 8 bits per character), this string is a bitstream of length $8 \times 35 = 280$. Strings of this sort are extremely important in modern biology, because biologists use the letters A, C, T, and G to represent the four nucleotides in the DNA of living organisms. A *genome* is a sequence of nucleotides. Scientists know that understanding the properties of genomes is a key to understanding the processes that manifest themselves in living organisms, including life, death, and disease. Genomes for many living things are known, and scientists are writing programs to study the structure of these sequences.

2-bit code compression. One simple property of genomes is that they contain only four different characters, so each can be encoded with just 2 bits per character, as in the `compress()` method shown at right. Even though we know the input stream to be character-encoded, we use `BinaryStdIn` to read the input, to emphasize adherence to the standard data-compression model (bitstream to bitstream).

We include the number of encoded characters in the compressed file, to ensure proper decoding if the last bit does not fall at the end of a byte. Since it converts each 8-bit character to a 2-bit code and just adds 32 bits for the length, this program approaches a 25 percent compression ratio as the number of characters increases.

2-bit code expansion. The `expand()` method at the top of the next page expands a bitstream produced by this `compress()` method. As with compression, this method reads a bitstream and writes a bitstream, in accordance with the basic data-compression model. The bitstream that we produce as output is the original input.

```
public static void compress()
{
    Alphabet DNA = new Alphabet("ACTG");
    String s = BinaryStdIn.readString();
    int N = s.length();
    BinaryStdOut.write(N);
    for (int i = 0; i < N; i++)
    { // Write two-bit code for char.
        int d = DNA.toIndex(s.charAt(i));
        BinaryStdOut.write(d, DNA.lgR());
    }
    BinaryStdOut.close();
}
```

Compression method for genomic data

```
public static void expand()
{
    Alphabet DNA = new Alphabet("ACTG");
    int w = DNA.lgR();
    int N = BinaryStdIn.readInt();
    for (int i = 0; i < N; i++)
    {
        // Read 2 bits; write char.
        char c = BinaryStdIn.readChar(w);
        BinaryStdOut.write(DNA.toChar(c));
    }
    BinaryStdOut.close();
}
```

Expansion method for genomic data

might require including the alphabet in the encoded message (see EXERCISE 5.5.25). The norm in data compression is to include such costs when comparing methods.

In the early days of genomics, learning a genomic sequence was a long and arduous task, so sequences were relatively short and scientists used standard ASCII encoding to store and exchange them. The experimental process has been vastly streamlined, to the point where known genomes are numerous and lengthy (the human genome is over 10^{10} bits), and the 75 percent savings achieved by these simple methods is very significant. Is there room for further compression? That is a very interesting question to contemplate, because it is a *scientific* question: the ability to compress implies the existence of some structure in the data, and a prime focus of modern genomics is to discover structure in genomic data. Standard data-compression methods like the ones we will consider are ineffective with (2-bit-encoded) genomic data, as with random data.

We package `compress()` and `expand()` as static methods in the same class, along with a simple driver, as shown at right. To test your understanding of the rules of the game and the basic tools that we use for data compression, make sure that you understand the various commands on the facing page that invoke `Genome.compress()` and `Genome.expand()` on our sample data (and their consequences).

THE SAME APPROACH works for other fixed-size alphabets, but we leave this generalization for an (easy) exercise (see EXERCISE 5.5.25).

These methods do not quite adhere to the standard data-compression model, because the compressed bitstream does not contain all the information needed to decode it. The fact that the alphabet is one of the letters A, C, T, or G is agreed upon by the two methods. Such a convention is reasonable in an application such as genomics, where the same code is widely reused. Other situations

```
public class Genome
{
    public static void compress()
        // See text.

    public static void expand()
        // See text.

    public static void main(String[] args)
    {
        if (args[0].equals("-")) compress();
        if (args[0].equals("+")) expand();
    }
}
```

Packaging convention for data-compression methods

tiny test case (264 bits)

```
% more genomeTiny.txt
ATAGATGCATAGCGCATAGCTAGATGTGCTAGC

java BinaryDump 64 < genomeTiny.txt
0100000101010100010000010100011101000001010101000100011101000011
010000010101010001000001010001110100001101000111010000110100001
0101010001000001010001110100001101010100010000010100011101000001
0101010001000111010101000100011101000011010101000100000101000111
01000011
264 bits

% java Genome - < genomeTiny.txt
?? ← cannot see bitstream on standard output

% java Genome - < genomeTiny.txt | java BinaryDump 64
000000000000000000000000000000000000000000000000000000000000000000
1000110010001100101101001000110011010010001101110100
1000110110001100101110110110001101000000
104 bits

% java Genome - < genomeTiny.txt | java HexDump 8
00 00 00 21 23 2d 23 74
8d 8c bb 63 40
104 bits

% java Genome - < genomeTiny.txt > genomeTiny.2bit
% java Genome + < genomeTiny.2bit
ATAGATGCATAGCGCATAGCTAGATGTGCTAGC ←

% java Genome - < genomeTiny.txt | java Genome +
ATAGATGCATAGCGCATAGCTAGATGTGCTAGC ← compress-expand cycle
produces original input
```

an actual virus (50000 bits)

```
% java PictureDump 512 100 < genomeVirus.txt
```

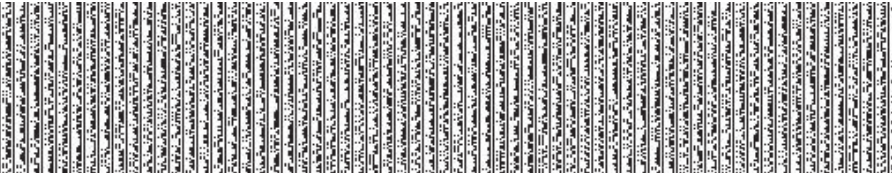

```
50000 bits

% java Genome - < genomeVirus.txt | java PictureDump 512 25
```



```
12536 bits
```

Compressing and expanding genomic sequences with 2-bit encoding

Run-length encoding The simplest type of redundancy in a bitstream is long runs of repeated bits. Next, we consider a classic method known as *run-length encoding* for taking advantage of this redundancy to compress data. For example, consider the following 40-bit string:

```
00000000000000001111111000000011111111111
```

This string consists of 15 0s, then 7 1s, then 7 0s, then 11 1s, so we can encode the bitstring with the numbers 15, 7, 7, and 11. All bitstrings are composed of alternating runs of 0s and 1s; we just encode the length of the runs. In our example, if we use 4 bits to encode the numbers and start with a run of 0s, we get the 16-bit string

```
1111011101111011
```

(15 = 1111, then 7 = 0111, then 7 = 0111, then 11 = 1011) for a compression ratio of $16/40 = 40$ percent. In order to turn this description into an effective data compression method, we have to consider the following issues:

- How many bits do we use to store the counts?
- What do we do when encountering a run that is longer than the maximum count implied by this choice?
- What do we do about runs that are shorter than the number of bits needed to store their length?

We are primarily interested in long bitstreams with relatively few short runs, so we address these questions by making the following choices:

- Counts are between 0 and 255, all encoded with 8 bits.
- We make all run lengths less than 256 by including runs of length 0 if needed.
- We encode short runs, even though doing so might lengthen the output.

These choices are very easy to implement and also very effective for several kinds of bitstreams that are commonly encountered in practice. They are *not* effective when short runs are numerous—we save bits on a run only when the length of the run is more than the number of bits needed to represent itself in binary.

Bitmaps. As an example of the effectiveness of run-length encoding, we consider *bitmaps*, which are widely used to represent pictures and scanned documents. For brevity and simplicity, we consider binary-valued bitmaps organized as bitstreams formed by taking the pixels in row-major order. To view the contents of a bitmap, we use `PictureDump`. Writing a program to convert an image from one of the many common lossless image formats that have been defined for “screen shots” or scanned documents into a bitmap is a simple matter (see `EXERCISE 5.5.X`). Our example to demonstrate the effectiveness of run-length encoding comes from screen shots of this book: a letter *q* (at various resolutions). We focus on a binary dump of a 32-by-48-pixel screen

```

public static void expand()
{
    boolean b = false;
    while (!BinaryStdIn.isEmpty())
    {
        char cnt = BinaryStdIn.readChar();
        for (int i = 0; i < cnt; i++)
            BinaryStdOut.write(b);
        b = !b;
    }
    BinaryStdOut.close();
}

public static void compress()
{
    char cnt = 0;
    boolean b, old = false;
    while (!BinaryStdIn.isEmpty())
    {
        b = BinaryStdIn.readBoolean();
        if (b != old)
        {
            BinaryStdOut.write(cnt);
            cnt = 0;
            old = !old;
        }
        else
        {
            if (cnt == 255)
            {
                BinaryStdOut.write(cnt);
                cnt = 0;
                BinaryStdOut.write(cnt);
            }
            cnt++;
        }
        BinaryStdOut.write(cnt);
        BinaryStdOut.close();
    }
}

```

Expand and compress methods for run-length encoding

Without run-length encoding, space requirements increase by a factor of 4 when the resolution is doubled; with run-length encoding, space requirements for the compressed bitstream just double when the resolution is doubled. That is, space grows and the compression ratio drops linearly with resolution. For example, our (low-resolution) letter *q* yields just a 74 percent compression ratio; if we increase the resolution to 64 by 96, the ratio drops to 37 percent. This change is graphically evident in the `PictureDump` outputs shown in the figure on the facing page. The higher-resolution letter takes four times the space of the lower resolution letter (double in both dimensions), but the compressed version takes just twice the space (double in one dimension). If we further increase the resolution to 128-by-192 (closer to what is needed for print), the ratio drops to 18 percent (see EXERCISE 5.5.5).

RUN-LENGTH ENCODING IS VERY EFFECTIVE in many situations, but there are plenty of cases where the bitstream we wish to compress (for example, typical English-language text) may have no long runs at all. Next, we consider two methods that are effective for a broad variety of files. They are widely used, and you likely have used one or both of these methods when downloading from the web.

tiny test case (40 bits)

```
% java BinaryDump 40 < 4runs.bin
000000000000000000001111111000000001111111111
40 bits

% java RunLength - < 4runs.bin | java HexDump
0f 07 07 0b
32 bits      compression ratio 32/40 = 80%

% java RunLength - < 4runs.bin | java RunLength + | java BinaryDump 40
000000000000000000001111111000000001111111111 ← compress-expand produces original input
40 bits
```

ASCII text (96 bits)

```
% java RunLength - < abra.txt | java HexDump 24
01 01 05 01 01 01 04 01 02 01 01 01 02 01 02 01 05 01 01 01 04 02 01 01
05 01 01 01 03 01 03 01 05 01 01 01 04 01 02 01 01 01 02 01 02 01 05 01
02 01 04 01
416 bits ← compression ratio 416/ = 433% — do not use run-length encoding for ASCII!
```

a bitmap (1536 bits)

```
% java RunLength - < q32x48.bin > q32x48.bin.rle
% java HexDump 16 < q32x48.bin.rle
4f 07 16 0f 0f 04 04 09 0d 04 09 06 0c 03 0c 05
0b 04 0c 05 0a 04 0d 05 09 04 0e 05 09 04 0e 05
08 04 0f 05 08 04 0f 05 07 05 0f 05 07 05 0f 05
07 05 0f 05 07 05 0f 05 07 05 0f 05 07 05 0f 05
07 05 0f 05 07 05 0f 05 07 06 0e 05 07 06 0e 05
08 06 0d 05 08 06 0d 05 09 06 0c 05 09 07 0b 05
0a 07 0a 05 0b 08 07 06 0c 14 0e 0b 02 05 11 05
05 05 1b 05 1b 05 1b 05 1b 05 1b 05 1b 05 1b 05
1b 05 1b 05 1b 05 1a 07 16 0c 13 0e 41
1144 bits ← compression ratio 1144/1536 = 74%
```

```
% java PictureDump 32 48 < q32x48.bin
```



1536 bits

```
% java PictureDump 32 36 < q32x48.rle.bin
```



1144 bits

a higher-resolution bitmap (6144 bits)

```
% java BinaryDump 0 < q64x96.bin
6144 bits
% java RunLength - < q64x96.bin | java BinaryDump 0
2296 bits ← compression ratio 2296/6144 = 37%
```

```
% java PictureDump 64 96 < q64x96.bin
```



6144 bits

```
% java PictureDump 64 36 < q64x96.rle.bin
```



2296 bits

Compressing and expanding bitstreams with run-length encoding

Huffman compression We now examine a data-compression technique that can save a substantial amount of space in natural language files (and many other kinds of files). The idea is to abandon the way in which text files are usually stored: instead of using the usual 7 or 8 bits for each character, we use fewer bits for characters that appear often than for those that appear rarely.

To introduce the basic ideas, we start with a small example. Suppose we wish to encode the string ABRACADABRA! Encoding it in 7-bit ASCII gives this bitstring:

```
100000110000101010010100000110000111000001-
100010010000011000010101001010000010100001.
```

To decode this bitstring, we simply read off 7 bits at a time and convert according to the ASCII coding table on page 815. In this standard code the D, which appears only once, requires the same number of bits as the A, which appears five times. Huffman compression is based on the idea that we can save bits by encoding frequently used characters with fewer bits than rarely used characters, thereby lowering the total number of bits used.

Variable-length prefix-free codes. A *code* associates each character with a bitstring: a symbol table with characters as keys and bitstrings as values. As a start, we might try to assign the shortest bitstrings to the most commonly used letters, encoding A with 0, B with 1, R with 00, C with 01, D with 10, and ! with 11, so ABRACADABRA! would be encoded as 0 1 00 0 01 0 10 0 1 00 0 11. This representation uses only 17 bits compared to the 77 for 7-bit ASCII, but it is not really a code because it depends on the blanks to delimit the characters. Without the blanks, the bitstring would be

```
01000010100100011
```

and could be decoded as CRRDDCRCB or as several other strings. Still, the count of 17 bits plus 10 delimiters is rather more compact than the standard code, primarily because no bits are used to encode letters not appearing in the message. The next step is to take advantage of the fact that *delimiters are not needed if no character code is the prefix of another*. A code with this property is known as a *prefix-free code*. The code just given is not prefix-free because 0, the code for A, is a prefix of 00, the code for R. For example, if we encode A with 0, B with 11111, C with 110, D with 100, R with 1110, and ! with 101, there is only one way to decode the 30-bit string

```
011111110011001000111111100101
```

ABRACADABRA! All prefix-free codes are *uniquely decodable* (without needing any delimiters) in this way, so prefix-free codes are widely used in practice. Note that fixed-length codes such as 7-bit ASCII are prefix-free.

Trie representation for prefix-free codes. One convenient way to represent a prefix-free code is with a trie (see SECTION 5.2). In fact, any trie with M null links defines a prefix-free code for M characters: we replace the null links by links to *leaves* (nodes with two null links), each containing a character to be encoded, and define the code for each character with the bitstring defined by the path from the root to the character, in the standard manner for tries where we associate 0 with moving left and 1 with moving right. For example, the figure at right shows two prefix-free codes for the characters in ABRACADABRA!. On top is the variable-length code just considered; below is a code that produces the string

110001111010111100110001111101

which is 29 bits, 1 bit shorter. Is there a trie that leads to even more compression? How do we find the trie that leads to the best prefix-free code? It turns out that there is an elegant answer to these questions in the form of an algorithm that computes a trie which leads to a bitstream of minimal length for any given string. To make a fair comparison with other codes, we also need to count the bits in the code itself, since the string cannot be decoded without it, and, as you will see, the code depends on the string. The general method for finding the optimal prefix-free code was discovered by D. Huffman (while a student!) in 1952 and is called *Huffman encoding*.

Overview. Using a prefix-free code for data compression involves five major steps. We view the bitstream to be encoded as a bytestream and use a prefix-free code for the characters as follows:

- Build an encoding trie.
- Write the trie (encoded as a bitstream) for use in expansion.
- Use the trie to encode the bytestream as a bitstream.

Then expansion requires that we

- Read the trie (encoded at the beginning of the bitstream)
- Use the trie to decode the bitstream

To help you best understand and appreciate the process, we consider these steps in order of difficulty.

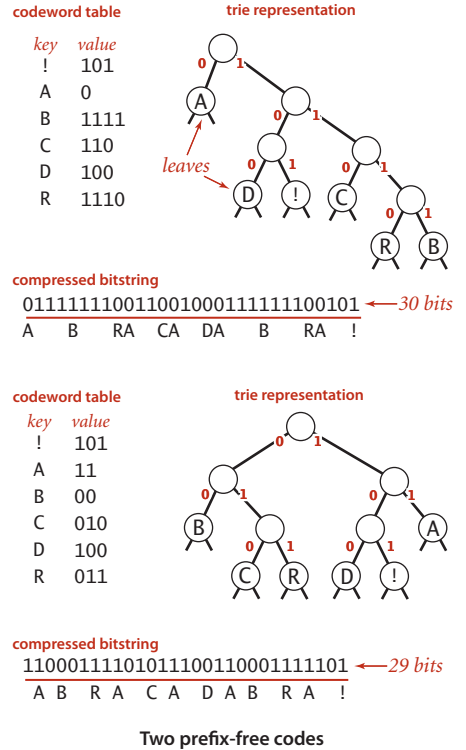

```
private static class Node implements Comparable<Node>
{ // Huffman trie node
  private char ch; // unused for internal nodes
  private int freq; // unused for expand
  private final Node left, right;

  Node(char ch, int freq, Node left, Node right)
  {
    this.ch = ch;
    this.freq = freq;
    this.left = left;
    this.right = right;
  }

  public boolean isLeaf()
  { return left == null && right == null; }

  public int compareTo(Node that)
  { return this.freq - that.freq; }
}
```

Trie node representation

```
public static void expand()
{
  Node root = readTrie();
  int N = BinaryStdIn.readInt();
  for (int i = 0; i < N; i++)
  { // Expand ith codeword.
    Node x = root;
    while (!x.isLeaf())
      if (BinaryStdIn.readBoolean())
        x = x.right;
      else x = x.left;
    BinaryStdOut.write(x.ch);
  }
  BinaryStdOut.close();
}
```

Prefix-free code expansion (decoding)

output A; go back to the root, move right three times, then output B; go back to the root, move right twice, then left, then output R; and so forth. The simplicity of expansion is one reason for the popularity of prefix-free codes in general and Huffman compression in particular.

Trie nodes. We begin with the Node class at left. It is similar to the nested classes that we have used before to construct binary trees and tries: each Node has left and right references to Nodes, which define the trie structure. Each Node also has an instance variable freq that is used in construction, and an instance variable ch, which is used in leaves to represent characters to be encoded.

Expansion for prefix-free codes. Expanding a bitstream that was encoded with a prefix-free code is simple, given the trie that defines the code. The

expand() method at left is an implementation of this process. After reading the trie from standard input using the readTrie() method to be described later, we use it to expand the rest of the bitstream as follows: Starting at the root, proceed down the trie as directed by the bitstream (read in input bit, move left if it is 0, and move right if it is 1). When you encounter a leaf, output the character at that node and restart at the root. If you study the operation of this method on the small prefix code example on the next page, you will understand and appreciate this process: For example, to decode the bitstring 011111001011 . . . we start at the root, move left because the first bit is 0,

```

private static String[] buildCode(Node root)
{ // Make a lookup table from trie.
  String[] st = new String[R];
  buildCode(st, root, "");
  return st;
}

private static void buildCode(String[] st, Node x, String s)
{ // Make a lookup table from trie (recursive).
  if (x.isLeaf())
  { st[x.ch] = s; return; }
  buildCode(st, x.left, s + '0');
  buildCode(st, x.right, s + '1');
}

```

Building an encoding table from a (prefix-free) code trie

Compression for prefix-free codes. For compression, we use the trie that defines the code to build the code table, as shown in the `buildCode()` method at the top of this page. This method is compact and elegant, but a bit tricky, so it deserves careful study. For any trie, it produces a table giving the bitstring associated with each character in the trie (represented as a `String` of 0s and 1s). The coding table is a symbol table that associates a `String` with each character: we use a character-indexed array `st[]` instead of a general symbol table for efficiency, because the number of characters is not large. To create it, `buildCode()` recursively walks the tree, maintaining a binary string that corresponds to the path from the root to each node (0 for left links and 1 for right links), and setting the codeword corresponding to each character when the character is found in a leaf. Once the coding table is built, compression is a simple matter: just look up the code for each character in the input. To use the encoding at right to compress `ABRACADABRA!` we write 0 (the codeword associated with A), then 111 (the codeword associated with B), then 110 (the codeword associated with R), and so forth. The code snippet at right accomplishes this task: we look up the `String` associated with each character in the input, convert it to 0/1 values in a char array, and write the corresponding bitstring to the output.

Codeword table

key	value
!	1010
A	0
B	111
C	1011
D	100
R	110

Trie representation

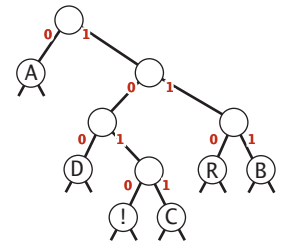

A Huffman code

```

for (int i = 0; i < input.length; i++)
{
  String code = st[input[i]];
  for (int j = 0; j < code.length(); j++)
    if (code.charAt(j) == '1')
      BinaryStdOut.write(true);
    else BinaryStdOut.write(false);
}

```

Compression with an encoding table

Trie construction. For reference as we describe the process, the figure on the facing page illustrates the process of constructing a Huffman trie for the input

it was the best of times it was the worst of times

We keep the characters to be encoded in leaves and maintain the `freq` instance variable in each node that represents the frequency of occurrence of all characters in the subtree rooted at that node. The first step is to create a forest of 1-node trees (leaves), one for each character in the input stream, each assigned a `freq` value equal to its frequency of occurrence in the input. In the example, the input has 8 ts, 5 es, 11 spaces, and so forth. (*Important note:* To obtain these frequencies, we need to read the whole input stream—Huffman encoding is a *two-pass* algorithm because we will need to read the input stream a second time to compress it.) Next, we build the coding trie from the bottom up according to the frequencies. When building the trie, we view it as a binary trie with frequencies stored in the nodes; after it has been built, we view it as a trie for coding, as just described. The process works as follows: we find the two nodes with the smallest frequencies and then create a new node with those two nodes as children (and with frequency value set to the sum of the values of the children). This operation reduces the number of tries in the forest by one. Then we iterate the process: find the two nodes with smallest frequency in that forest and a create a new node created in the same way. Implementing the process is straightforward with a priority queue, as shown in the `buildTrie()` method on page 830. (For clarity, the tries in the figure are kept in sorted order.) Continuing, we build up larger and larger tries and at the same time reduce the number of tries in the forest by one at each step (remove two, add one). Ultimately, all the

```
private static Node buildTrie(int[] freq)
{
    // Initialize priority queue with singleton trees.
    MinPQ<Node> pq = new MinPQ<Node>();
    for (char c = 0; c < R; c++)
        if (freq[c] > 0)
            pq.insert(new Node(c, freq[c], null, null));

    while (pq.size() > 1)
    { // Merge two smallest trees.
        Node x = pq.delMin();
        Node y = pq.delMin();
        Node parent = new Node('\0', x.freq + y.freq, x, y);
        pq.insert(parent);
    }
    return pq.delMin();
}
```

Building a Huffman encoding trie

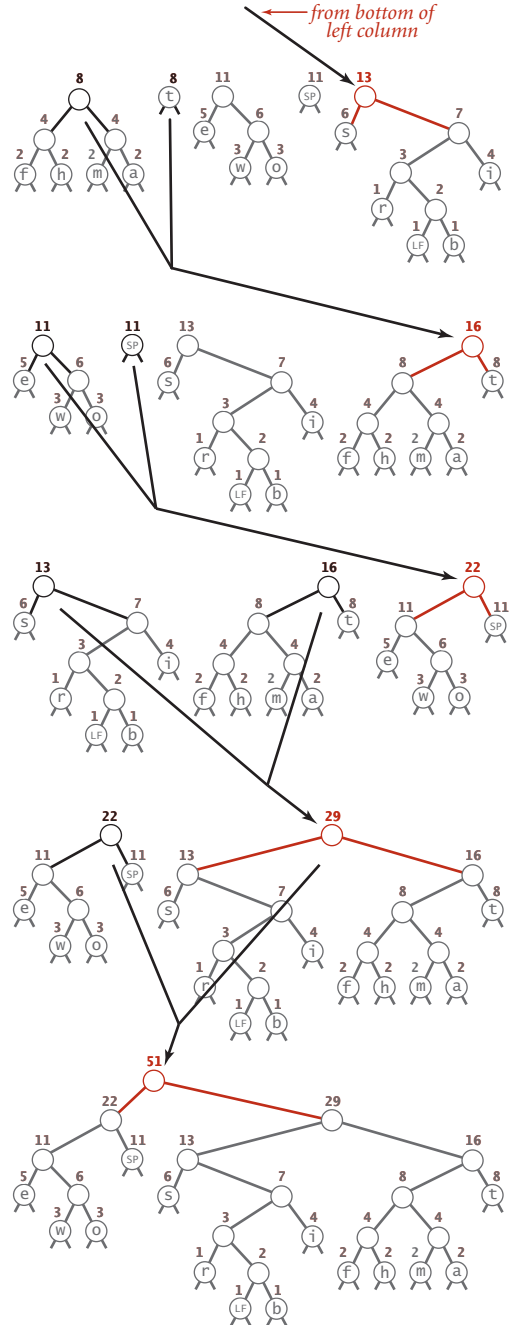
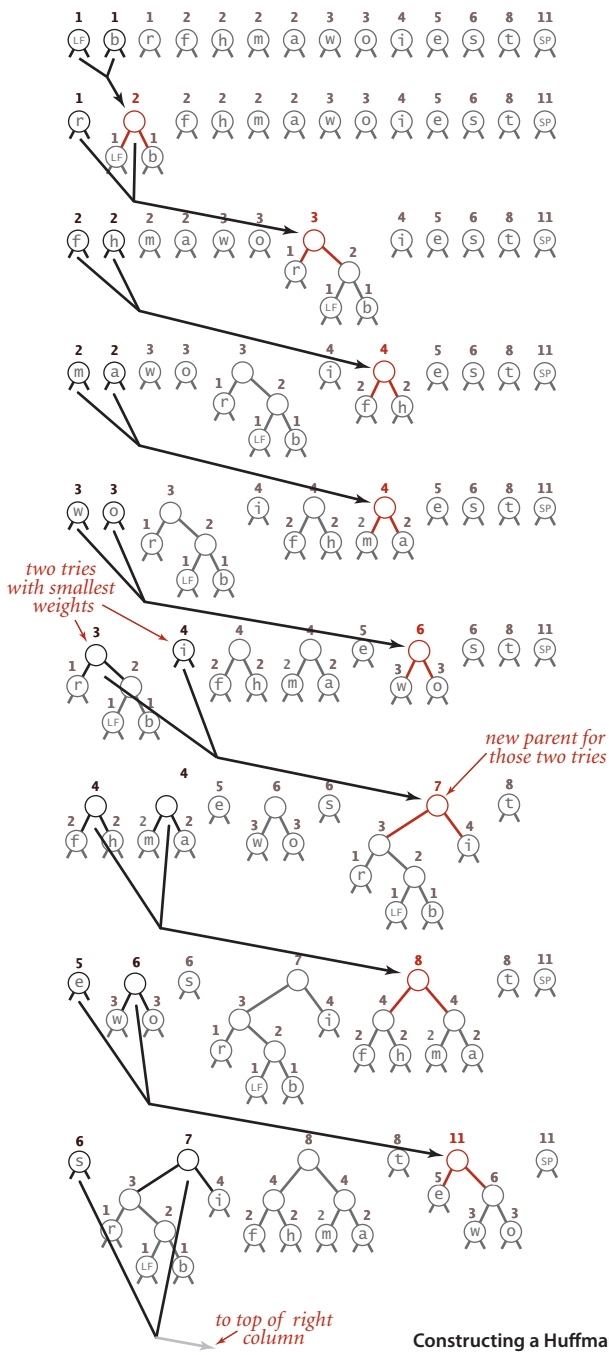

Constructing a Huffman encoding trie

trie representation

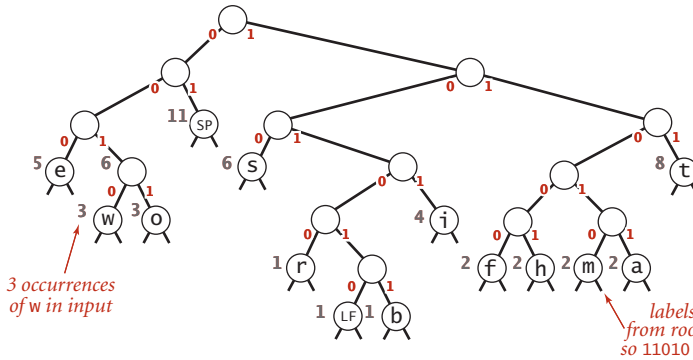

codeword table

key	value
LF	101010
SP	01
a	11011
b	101011
e	000
f	11000
h	11001
i	1011
m	11010
o	0011
r	10100
s	100
t	111
w	0010

Huffman code for the character stream “it was the best of times it was the worst of times LF”

nodes are combined together into a single trie. The leaves in this trie have the characters to be encoded and their frequencies in the input; each non-leaf node is the sum of the frequencies of its two children. Nodes with low frequencies end up far down in the trie, and nodes with high frequencies end up near the root of the trie. The frequency in the root equals the number of characters in the input. Since it is a binary trie with characters only in its leaves, it defines a prefix-free code for the characters. Using the codeword table created by `buildCode()` for this example (shown at right in the diagram at the top of this page), we get the output bitstring

```
10111110100101101110001111110010000110101100-
01001110100111100001111101111010000100011011-
11101001011011100011111100100001001000111010-
01001110100111100001111101111010000100101010.
```

which is 176 bits, a savings of 57 percent over the 408 bits needed to encode the 51 characters in standard 8-bit ASCII (not counting the cost of including the code, which we will soon consider). Moreover, since it is a *Huffman* code, no other prefix-free code can encode the input with fewer bits.

Optimality. We have observed that high-frequency characters are nearer the root of the tree than lower-frequency characters and are therefore encoded with fewer bits, so this is a good code, but why is it an *optimal* prefix-free code? To answer this question, we begin by defining the *weighted external path length* of a tree to be the sum of the weight (associated frequency count) times depth (see page 226) of all of the leaves.

Proposition T. For any prefix-free code, the length of the encoded bitstring is equal to the weighted external path length of the corresponding trie.

Proof: The depth of each leaf is the number of bits used to encode the character in the leaf. Thus, the weighted external path length is the length of encoded bitstring: it is equivalent to the sum over all letters of the number of occurrences times the number of bits per occurrence.

For our example, there is one leaf at distance 2 (sp, with frequency 11), three leaves at distance 3 (e, s, and t, with total frequency 19), three leaves at distance 4 (w, o, and i, with total frequency 10), five leaves at distance 5 (r, f, h, m, and a, with total frequency 9) and two leaves at distance 6 (lf and b, with total frequency 2), so the sum total is $2 \cdot 11 + 3 \cdot 19 + 4 \cdot 10 + 5 \cdot 9 + 6 \cdot 2 = 176$, the length of the output bitstring, as expected.

Proposition U. Given a set of r symbols and frequencies, the Huffman algorithm builds an optimal prefix-free code.

Proof: By induction on r . Assume that the Huffman code is optimal for any set of fewer than r symbols. Let T_H be the code computed by Huffman for the set of symbols and associated frequencies $(s_1, r_1), \dots, (s_r, r_r)$ and denote the length of the code (weighted external path length of the trie) by $W(T_H)$. Suppose that (s_i, f_i) and (s_j, f_j) are the first two symbols chosen. The algorithm then computes the code T_H^* for the set of $n-1$ symbols with (s_i, f_i) and (s_j, f_j) replaced by $(s^*, f_i + f_j)$ where s^* is a new symbol in a leaf at some depth d . Note that

$$W(T_H) = W(T_H^*) - d(f_i + f_j) + (d + 1)(f_i + f_j) = W(T_H^*) + (f_i + f_j)$$

Now consider an optimal trie T for $(s_1, r_1), \dots, (s_r, r_r)$, of height h . Note that (s_i, f_i) and (s_j, f_j) must be at depth h (else we could make a trie with lower external path length by swapping them with nodes at depth h). Also, assume (s_i, f_i) and (s_j, f_j) are siblings by swapping (s_j, f_j) with (s_i, f_i) 's sibling. Now consider the tree T^* obtained by replacing their parent with $(s^*, f_i + f_j)$. Note that (by the same argument as above) $W(T) = W(T^*) + (f_i + f_j)$.

By the inductive hypothesis T_H^* is optimal: $W(T_H^*) \leq W(T^*)$. Therefore,

$$W(T_H) = W(T_H^*) + (f_i + f_j) \leq W(T^*) + (f_i + f_j) = W(T)$$

Since T is optimal, equality must hold, and T_H is optimal.

Whenever a node is to be picked, it can be the case that there are several nodes with the same weight. Huffman's method does not specify how such ties are to be broken. It also does not specify the left/right positions of the children. Different choices lead to

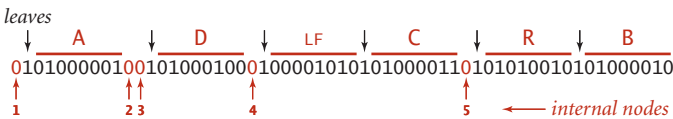
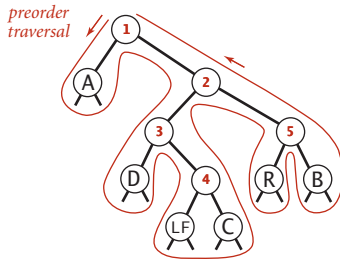

Using preorder traversal to encode a trie as a bitstream

full data-compression scheme, we must write the trie onto a bitstream when compressing and read it back when expanding. How can we encode a trie as a bitstream, and then expand it? Remarkably, both tasks can be achieved with simple recursive procedures, based on a *preorder traversal* of the trie. The procedure `writeTrie()` below traverses a trie in preorder: when it visits an internal node, it writes a single 0 bit; when it visits a leaf, it writes a 1 bit, followed by the 8-bit ASCII code of the character in the leaf. The bitstring encoding of the Huffman trie for our `ABRACADABRA!` example is shown above. The first bit is 0, corresponding to the root; since the leaf containing `A` is encountered next, the next bit is 1, followed by `0100001`, the 8-bit ASCII code for `A`; the next two bits are 0 because two internal nodes are encountered next, and so forth. The corresponding method `readTrie()` on page 835 reconstructs the trie from the bitstring: it reads a single bit to learn which type of node comes next: if a leaf (the bit is 1) it reads the next character and creates a leaf; if an internal node (the bit is 0) it creates an internal node and

different Huffman codes, but all such codes will encode the message with the optimal number of bits among prefix-free codes.

Writing and reading the trie. As we have emphasized, the savings figure quoted above is not entirely accurate, because the compressed bitstream cannot be encoded without the trie, so we must account for the cost of including the trie in the compressed output, along with the bitstring. For long inputs, this cost is relatively small, but in order for us to have a

```
private static void writeTrie(Node x)
{ // Write bitstring-encoded trie.
  if (x.isLeaf())
  {
    BinaryStdOut.write(true);
    BinaryStdOut.write(x.ch);
    return;
  }
  BinaryStdOut.write(false);
  writeTrie(x.left);
  writeTrie(x.right);
}
```

Writing a trie as a bitstring

```
private static Node readTrie()
{
    if (BinaryStdIn.readBoolean())
        return new Node(BinaryStdIn.readChar(), 0, null, null);
    return new Node('\0', 0, readTrie(), readTrie());
}
```

Reconstructing a trie from the preorder bitstring representation

then (recursively) builds its left and right subtrees. *Be sure that you understand these methods:* their simplicity is somewhat deceiving.

Huffman compression implementation. Along with the methods `buildCode()`, `buildTrie()`, `readTrie()` and `writeTrie()` that we have just considered (and the `expand()` method that we considered first), ALGORITHM 5.10 is a complete implementation of Huffman compression. To expand the overview that we considered several pages earlier, we view the bitstream to be encoded as a stream of 8-bit char values and compress it as follows:

- Read the input.
- Tabulate the frequency of occurrence of each char value in the input.
- Build the Huffman encoding trie corresponding to those frequencies.
- Build the corresponding codeword table, to associate a bitstring with each char value in the input.
- Write the trie, encoded as a bitstring.
- Write the count of characters in the input, encoded as a bitstring.
- Use the codeword table to write the codeword for each input character.

To expand a bitstream encoded in this way, we

- Read the trie (encoded at the beginning of the bitstream)
- Read the count of characters to be decoded
- Use the trie to decode the bitstream

With four recursive trie-processing methods and a seven-step compression process, Huffman compression is one of the more involved algorithms that we have considered, but it is also one of the most widely-used, because of its effectiveness.

ALGORITHM 5.10 Huffman compression

```
public class Huffman
{
    private static int R = 256;    // ASCII alphabet
    // See page 828 for inner Node class.
    // See text for helper methods and expand().

    public static void compress()
    {
        // Read input.
        String s = BinaryStdIn.readString();
        char[] input = s.toCharArray();

        // Tabulate frequency counts.
        int[] freq = new int[R];
        for (int i = 0; i < input.length; i++)
            freq[input[i]]++;

        // Build Huffman code trie.
        Node root = buildTrie(freq);

        // Build code table (recursive).
        String[] st = new String[R];
        buildCode(st, root, "");

        // Print trie for decoder (recursive).
        writeTrie(root);

        // Print number of chars.
        BinaryStdOut.write(input.length);

        // Use Huffman code to encode input.
        for (int i = 0; i < input.length; i++)
        {
            String code = st[input[i]];
            for (int j = 0; j < code.length(); j++)
                if (code.charAt(j) == '1')
                    BinaryStdOut.write(true);
                else BinaryStdOut.write(false);
        }
        BinaryStdOut.close();
    }
}
```

This implementation of Huffman encoding builds an explicit coding trie, using various helper methods that are presented and explained in the last several pages of text.

ONE REASON FOR THE POPULARITY of Huffman compression is that it is effective for various types of files, not just natural language text. We have been careful to code the method so that it can work properly for any 8-bit value in each 8-bit character. In other words, we can apply it to any bytestream whatsoever. Several examples, for file types that we have considered earlier in this section, are shown in the figure at the bottom of this page. These examples show that Huffman compression is competitive with both fixed-length encoding and run-length encoding, even though those methods are designed to perform well for certain types of files. Understanding the reason Huffman encoding performs well in these domains is instructive. In the case of genomic data, Huffman compression essentially discovers a 2-bit code, as the four letters appear with approximately equal frequency so that the Huffman trie is balanced, with each character assigned a 2-bit code. In the case of run-length encoding, 00000000 and 11111111 are likely to be the most frequently occurring characters, so they are likely to be encoded with 2 or 3 bits, leading to substantial compression.

virus (50000 bits)

```
% java Genome - < genomeVirus.txt | java PictureDump 512 25
```



12536 bits

```
% java Huffman - < genomeVirus.txt | java PictureDump 512 25
```



12576 bits ← *Huffman compression needs just 40 more bits than custom 2-bit code*

bitmap (1536 bits)

```
% java RunLength - < q32x48.bin | java BinaryDump 0
```

1144 bits

```
% java Huffman - < q32x48.bin | java BinaryDump 0
```

816 bits ← *Huffman compression uses 29% fewer bits than customized method*

higher-resolution bitmap (6144 bits)

```
% java RunLength - < q64x96.bin | java BinaryDump 0
```

2296 bits

```
% java Huffman - < q64x96.bin | java BinaryDump 0
```

2032 bits ← *gap narrows to 11% for higher resolution*

Compressing and expanding genomic data and bitmaps with Huffman encoding

A remarkable alternative to Huffman compression that was developed in the late 1970s and the early 1980s by A. Lempel, J. Ziv, and T. Welch has emerged as one of the most widely used compression methods because it is easy to implement and works well for a variety of file types.

The basic plan complements the basic plan for Huffman coding. Rather than maintain a table of *variable*-length codewords for *fixed*-length patterns in the input, we maintain a table of *fixed*-length codewords for *variable*-length patterns in the input. A surprising added feature of the method is that, by contrast with Huffman encoding, *we do not have to encode the table*.

LZW compression. To fix ideas, we will consider a compression example where we read the input as a stream of 7-bit ASCII characters and write the output as a stream of 8-bit bytes. (In practice, we typically use larger values for these parameters—our implementations use 8-bit inputs and 12-bit outputs.) We refer to input bytes as *characters*, sequences of input bytes as *strings*, and output bytes as *codewords*, even though these terms have slightly different meanings in other contexts. The LZW compression algorithm is based on maintaining a symbol table that associates string keys with (fixed-length) codeword values. We initialize the symbol table with the 128 possible single-character string keys and associate them with 8-bit codewords obtained by prepending 0 to the 7-bit value defining each character. For economy and clarity, we use hexadecimal to refer to codeword values, so 41 is the codeword for ASCII A, 52 for R, and so forth. We reserve the codeword 80 to signify end of file. We will assign the rest of the codeword values (81 through FF) to various substrings of the input that we encounter, by starting at 81 and incrementing the value for each new key added. To compress, we perform the following steps as long as there are unscanned input characters:

- Find the longest string *s* in the symbol table that is a prefix of the unscanned input.
- Write the 8-bit value (codeword) associated with *s*.
- Scan one character past *s* in the input.
- Associate the next codeword value with *s* + *c* (*c* appended to *s*) in the symbol table, where *c* is the next character in the input.

In the last of these steps, we look ahead to see the next character in the input to build the next dictionary entry, so we refer to that character *c* as the *lookahead* character. For the moment, we simply stop adding entries to the symbol table when we run out of codeword values (after assigning the value FF to some string)—we will later discuss alternate strategies.

LZW compression example. The figure below gives details of the operation of LZW compression for the example input ABRACADABRABRABRA. For the first seven characters, the longest prefix match is just one character, so we output the codeword associated with the character and associate the codewords from 81 through 87 to two-character strings. Then we find prefix matches with AB (so we output 81 and add ABR to the table), RA (so we output 83 and add RAC to the table), BR (so we output 82 and add BRA to the table), and ABR (so we output 88 and add ABRA to the table), leaving the last A (so we output its codeword, 41).

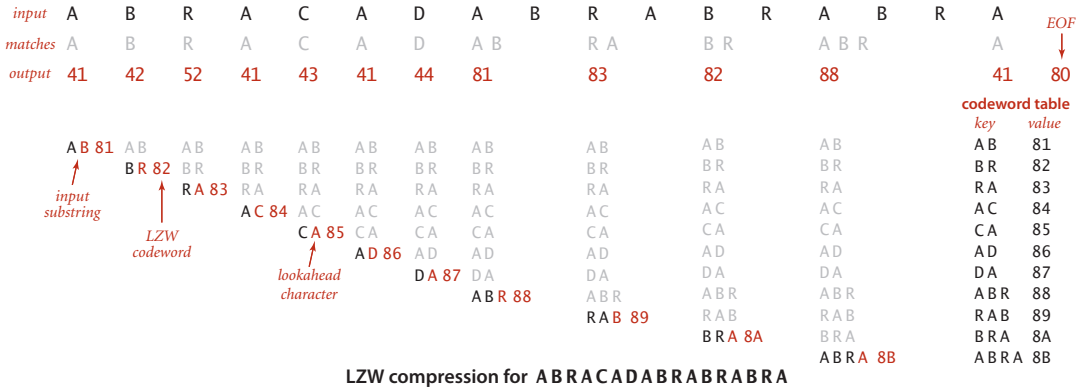

The input is 17 ASCII characters of 7 bits each for a total of 119 bits; the output is 12 codewords of 8 bits each for a total of 96 bits—a compression ratio of 82 percent even for this tiny example.

LZW trie representation. LZW compression involves two symbol-table operations:

- Find a longest-prefix match of the input with a symbol-table key.
- Add an entry associating the next codeword with the key formed by appending the lookahead character to that key.

Our trie data structures of SECTION 5.2 are tailor-made for these operations. The trie representation for our example is shown at right. To find a longest prefix match, we traverse the trie from the root, matching node labels with input characters; to add a new codeword, we connect a new node labeled with the next codeword and the lookahead character to the node where the search terminated. In practice, we use a TST for

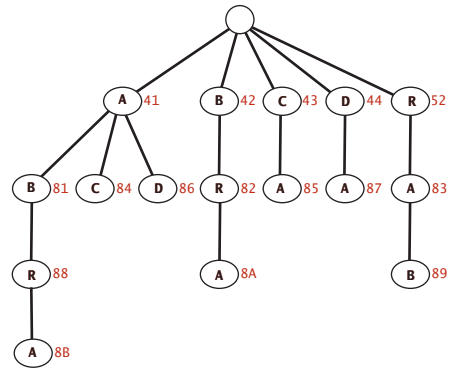

Trie representation of LZW code table

ALGORITHM 5.11 LZW compression

```

public class LZW
{
    private static final int R = 256;           // number of input chars
    private static final int L = 4096;         // number of codewords = 2^12
    private static final int W = 12;          // codeword width

    public static void compress()
    {
        String input = BinaryStdIn.readString();
        TST<Integer> st = new TST<Integer>();

        for (int i = 0; i < R; i++)
            st.put("" + (char) i, i);
        int code = R+1; // R is codeword for EOF.

        while (input.length() > 0)
        {
            String s = st.longestPrefixOf(input); // Find max prefix match.
            BinaryStdOut.write(st.get(s), W);     // Print s's encoding.
            int t = s.length();
            if (t < input.length() && code < L) // Add s to symbol table.
                st.put(input.substring(0, t + 1), code++);
            input = input.substring(t);           // Scan past s in input.
        }

        BinaryStdOut.write(R, W);                // Write EOF.
        BinaryStdOut.close();
    }

    public static void expand()
    // See page 844.
}

```

This implementation of Lempel-Ziv-Welch data compression uses 8-bit input bytes and 12-bit codewords and is appropriate for arbitrary large files. Its codewords for the small example are similar to those discussed in the text: the single-character codewords have a leading 0; the others start at 100.

```

% more abraLZW.txt
ABRACADABRABRABRA

% java LZW - < abraLZW.txt | java HexDump 20
04 10 42 05 20 41 04 30 41 04 41 01 10 31 02 10 80 41 10 00
160 bits

```

the end of the process, we have written the original input, as expected, and also built the same code table as for compression, but with the key-value roles inverted. Note that we can use a simple array-of-strings representation for the table, indexed by codeword.

Tricky situation. There is a subtle bug in the process just described, one that is often discovered by students (and experienced programmers!) only after developing an implementation based on the description above.

The problem, illustrated in the example at right, is that it is possible for the lookahead process to get one character ahead of itself. In the example, the input string

A B A B A B A

is compressed to five output codewords

41 42 81 83 80

as shown in the top part of the figure. To expand, we read the codeword 41, output A, read the codeword 42 to get the lookahead character, add AB as table entry 81, output the B associated with 42, read the codeword 81 to get the lookahead character, add BA as table entry 82, and output the AB associated with 81. So far, so good. But when we read the codeword 83 to get the lookahead character, we are stuck, because the reason that we are reading that codeword is to complete table entry 83! Fortunately, it is easy to test for that condition (it happens precisely when the codeword is the same as the table entry to be completed) and to correct it (the lookahead character must be the first character in that table entry, since that will be the next character to be output). In this example, this logic tells us that the lookahead character must be A (the first character in ABA). Thus, both the next output string and table entry 83 should be ABA.

Implementation. With these descriptions, implementing LZW encoding is straightforward, given in ALGORITHM 5.11 on the facing page (the implementation of `expand()` is on the next page). These implementations take 8-bit bytes as input (so we can compress any file, not just strings) and produce 12-bit codewords as output (so that we can get better compression by having a much larger dictionary). These values are specified in the (final) instance variables `R`, `L`, and `W` in the code. We use a TST (see SECTION 5.2) for the code table in `compress()` (taking advantage of the ability of trie data structures to support efficient implementations of `longestPrefixOf()`) and an array of strings

compression							
input	A	B	A	B	A	B	A
matches	A	B	A B		A B A		
output	41	42	81		83		80

A B 81	A B	A B	
B A 82	B A	A B A 83	

codeword table	
key	value
A B	81
B A	82
A B A	83

expansion					
input	41	42	81	83	80
output	A	B	A B	?	← must be A B A (see below)

81	A B	A B	A B
82	B A	B A	A B ?
83	A B ?		

↑ need lookahead character to complete entry

↑ next character in output—the lookahead character!

LZW expansion: tricky situation

ALGORITHM 5.11 (continued) LZW expansion

```

public static void expand()
{
    String[] st = new String[L];
    int i; // next available codeword value
    for (i = 0; i < R; i++) // Initialize table for chars.
        st[i] = "" + (char) i;
    st[i++] = " "; // (unused) lookahead for EOF
    int codeword = BinaryStdIn.readInt(W);
    String val = st[codeword];
    while (true)
    {
        BinaryStdOut.write(val); // Write current substring.
        codeword = BinaryStdIn.readInt(W);
        if (codeword == R) break;
        String s = st[codeword]; // Get next codeword.
        if (i == codeword) // If lookahead is invalid,
            s = val + val.charAt(0); // make codeword from last one.
        if (i < L)
            st[i++] = val + s.charAt(0); // Add new entry to code table.
        val = s; // Update current codeword.
    }
    BinaryStdOut.close();
}

```

This implementation of expansion for the Lempel-Ziv-Welch algorithm is a bit more complicated than compression because of the need to extract the lookahead character from the next codeword and because of a tricky situation where lookahead is invalid (see text).

```

% java LZW - < abraLZW.txt | java LZW +
ABRACADABRABRABRA

% more ababLZW.txt
ABABABA

% java LZW - < ababLZW.txt | java LZW +
ABABABA

```

for the inverse code table in `expand()`. With these choices, the code for `compress()` and `expand()` is little more than a line-by-line translation of the descriptions in the text. These methods are very effective as they stand. For certain files, they can be further improved by emptying the codeword table and starting over each time all the codeword values are used. These improvements, along with experiments to evaluate their effectiveness, are addressed in the exercises at the end of this section.

AS USUAL, it is worth your while to study carefully the examples given with the programs and at the bottom of this page of LZW compression in action. Over the several decades since its invention, it has proven to be a versatile and effective data-compression method.

virus (50000 bits)

```
% java Genome - < genomeVirus.txt | java PictureDump 512 25
```



12536 bits

```
% java LZW - < genomeVirus.txt | java PictureDump 512 36
```



18232 bits ← *not as good as 2-bit code because repetitive data is rare*

bitmap (6144 bits)

```
% java RunLength - < q64x96.bin | java BinaryDump 0
```

2296 bits

```
% java LZW - < q64x96.bin | java BinaryDump 0
```

2824 bits ← *not as good as run-length code because file size is too small*

entire text of *Tale of Two Cities* (5812552 bits)

```
% java BinaryDump 0 < tale.txt
```

5812552 bits

```
% java Huffman - < tale.txt | java BinaryDump 0
```

3043928 bits

```
% java LZW - < tale.txt | java BinaryDump 0
```

2667952 bits ← *compression ratio 2667952/5812552 = 46% (best yet)*

Compressing and expanding various files with LZW 12-bit encoding

Q&A

Q. Why `BinaryStdIn` and `BinaryStdOut`?

A. It's a tradeoff between efficiency and convenience. `StdIn` can handle 8 bits at a time; `BinaryStdIn` has to handle each bit. Most applications are bytestream-oriented; data compression is a special case.

Q. Why `close()`?

A. This requirement stems from the fact that standard output is actually a bytestream, so `BinaryStdOut` needs to know when to write the last byte.

Q. Can we mix `StdIn` and `BinaryStdIn`?

A. That is not a good idea. Because of system and implementation dependencies, there is no guarantee of what might happen. Our implementations will raise an exception. On the other hand, there is no problem with mixing `StdOut` and `BinaryStdOut` (we do it in our code).

Q. Why is the `Node` class `static` in `Huffman`?

A. Our data-compression algorithms are organized as collections of static methods, not data-type implementations.

Q. Can I at least guarantee that my compression algorithm will not increase the length of a bitstream?

A. You can just copy it from input to output, but you still need to signify not to use a standard compression scheme. Commercial implementations sometimes make this guarantee, but it is quite weak and far from universal compression. Indeed, typical compression algorithms do not even make it past the second step of our first proof of **PROPOSITION 5**: few algorithms will further compress a bitstring produced by that same algorithm.

EXERCISES

5.5.1 Consider the four variable-length codes shown in the table at right. Which of the codes are prefix-free? Uniquely decodable? For those that are uniquely decodable, give the encoding of 1000000000000.

symbol	code 1	code 2	code 3	code 4
A	0	0	1	1
B	100	1	01	01
C	10	00	001	001
D	11	11	0001	000

5.5.2 Given an example of a uniquely decodable code that is not prefix-free.

Answer: Any *suffix-free* code is uniquely decodable.

5.5.3 Give an example of a uniquely decodable code that is not prefix free or suffix free.

Answer: {0011, 011, 11, 1110} or {01, 10, 011, 110}

5.5.4 Are {01, 1001, 1011, 111, 1110} and {01, 1001, 1011, 111, 1110} uniquely decodable? If not, find a string with two encodings.

5.5.5 Use RunLength on the file q128x192.bin from the booksite. How many bits are there in the compressed file?

5.5.6 How many bits are needed to encode N copies of the symbol a (as a function of N)? N copies of the sequence abc ?

5.5.7 Give the result of encoding the strings a , aa , aaa , $aaaa$, ... (strings consisting of N a 's) with run-length, Huffman, and LZW encoding. What is the compression ratio as a function of N ?

5.5.8 Give the result of encoding the strings ab , $abab$, $ababab$, $abababab$, ... (strings consisting of N repetitions of ab) with run-length, Huffman, and LZW encoding. What is the compression ratio as a function of N ?

5.5.9 Estimate the compression ratio achieved by run-length, Huffman, and LZW encoding for a *random* ASCII string of length N (all characters equally likely at each position, independently).

5.5.10 In the style of the figure in the text, show the Huffman coding tree construction process when you use Huffman for the string "it was the age of foolishness". How many bits does the compressed bitstream require?

EXERCISES *(continued)*

5.5.11 What is the Huffman code for a string whose characters are all from a two-character alphabet? Give an example showing the maximum number of bits that could be used in a Huffman code for an N -character string whose characters are all from a two-character alphabet.

5.5.12 Suppose that all of the symbol probabilities are negative powers of 2. Describe the Huffman code.

5.5.13 Suppose that all of the symbol frequencies are equal. Describe the Huffman code.

5.5.14 Suppose that the frequencies of the occurrence of all the characters to be encoded are different. Is the Huffman encoding tree unique?

5.5.15 Huffman coding could be extended in a straightforward way to encode in 2-bit characters (using 4-way trees). What would be the main advantage and the main disadvantage of doing so?

5.5.16 What is the LZW encoding of the following inputs?

- a. T O B E O R N O T T O B E
- b. Y A B B A D A B B A D A B B A D O O
- c. A A A A A A A A A A A A A A A A A A

5.5.17 Characterize the tricky situation in LZW coding.

Solution: Whenever it encounters $cScSc$, where c is a symbol and S is a string, cS is in the dictionary already but cSc is not.

5.5.18 Let F_k be the k th Fibonacci number. Consider N symbols, where the k th symbol has frequency F_k . Note that $F_1 + F_1 + \dots + F_N = F_{N+2} - 1$. Describe the Huffman code. *Hint:* The longest codeword has length $N - 1$.

5.5.19 Show that there are at least 2^{N-1} different Huffman codes corresponding to a given set of N symbols.

5.5.20 Give a Huffman code where the frequency of 0s in the output is much, much higher than the frequency of 1s.

Answer: If the character A occurs 1 million times and the character B occurs once, the codeword for A will be 0 and the codeword for B will be 1.

5.5.21 Prove that the two longest codewords in a Huffman code have the same length.

5.5.22 Prove the following fact about Huffman codes: If the frequency of symbol i is strictly larger than the frequency of symbol j , then the length of the codeword for symbol i is less than or equal to the length of the codeword for symbol j .

5.5.23 What would be the result of breaking up a Huffman-encoded string into five-bit characters and Huffman-encoding that string?

5.5.24 In the style of the figures in the text, show the encoding trie and the compression and expansion processes when LZW is used for the string

`it was the best of times it was the worst of times`

CREATIVE PROBLEMS

5.5.25 *Fixed length width code.* Implement a class RLE that uses fixed-length encoding, to compress ASCII bytestreams using relatively few different characters, including the code as part of the encoded bitstream. Add code to `compress()` to make a string `alpha` with all the distinct characters in the message and use it to make an `Alphabet` for use in `compress()`, prepend `alpha` (8-bit encoding plus its length) to the compressed bitstream, then add code to `expand()` to read the alphabet before expansion.

5.5.26 *Rebuilding the LZW dictionary.* Modify LZW to empty the dictionary and start over when it is full. This approach is recommended in some applications because it better adapts to changes in the general character of the input.

5.5.27 *Long repeats.* Estimate the compression ratio achieved by run-length, Huffman, and LZW encoding for a string of length $2N$ formed by concatenating *two copies* of a random ASCII string of length N (see EXERCISE 5.5.9), under any assumptions that you think are reasonable.

This page intentionally left blank

SIX



Context

COMPUTING DEVICES ARE UBIQUITOUS in the modern world. In the last several decades, we have evolved from a world where computing devices were virtually unknown to a world where billions of people use them regularly. Moreover, today's cellphones are orders of magnitude more powerful than the supercomputers that were available only to the privileged few as little as 30 years ago. But many of the underlying algorithms that enable these devices to work effectively are the same ones that we have studied in this book. Why? *Survival of the fittest*. Scalable (linear and linearithmic) algorithms have played a central role in the process and validate the idea that efficient algorithms are important. Researchers of the 1960s and 1970s built the basic infrastructure that we now enjoy with such algorithms. They knew that scalable algorithms are the key to the future; the developments of the past several decades have validated that vision. Now that the infrastructure is built, people are beginning to *use* it, for all sorts of purposes. As B. Chazelle has famously observed, the 20th century was the century of the equation, but the 21st century is the century of the *algorithm*.

Our treatment of fundamental algorithms in this book is only a starting point. The day is soon coming (if it is not already here) when one could build a college major around the study of algorithms. In commercial applications, scientific computing, engineering, operations research (OR), and countless other areas of inquiry too diverse to even mention, efficient algorithms make the difference between being able to solve problems in the modern world and not being able to address them at all. Our emphasis throughout this book has been to study *important* and *useful* algorithms. In this chapter, we reinforce this orientation by considering examples that illustrate the role of the algorithms that we have studied (and our approach to the study of algorithms) in

several advanced contexts. To indicate the scope of the impact of the algorithms, we begin with a very brief description of several important areas of application. To indicate the depth, we later consider specific representative examples in detail and introduce the theory of algorithms. In both cases, this brief treatment at the end of a long book can only be indicative, not inclusive. For every area of application that we mention, there are dozens of others, equally broad in scope; for every point that we describe within an application, there are scores of others, equally important; and for every detailed example we consider, there are hundreds if not thousands of others, equally impactful.

Commercial applications. The emergence of the internet has underscored the central role of algorithms in *commercial applications*. All of the applications that you use regularly benefit from the classic algorithms that we have studied:

- Infrastructure (operating systems, databases, communications)
- Applications (email, document processing, digital photography)
- Publishing (books, magazines, web content)
- Networks (wireless networks, social networks, the internet)
- Transaction processing (financial, retail, web search)

As a prominent example, we consider in this chapter *B-trees*, a venerable data structure that was developed for mainstream computers of the 1960s but still serve as the basis for modern database systems. We will also discuss *suffix arrays*, for text indexing.

Scientific computing. Since von Neumann developed mergesort in 1950, algorithms have played a central role in *scientific computing*. Today's scientists are awash in experimental data and are using both mathematical and computational models to understand the natural world for:

- Mathematical calculations (polynomials, matrices, differential equations)
- Data processing (experimental results and observations, especially genomics)
- Computational models and simulation

All of these can require complex and extensive computing with huge amounts of data. As a detailed example of an application in scientific computing, we consider in this chapter a classic example of *event-driven simulation*. The idea is to maintain a model of a complicated real-world system, controlling changes in the model over time. There are a vast number of applications of this basic approach. We also consider a fundamental data-processing problem in computational genomics.

Engineering. Almost by definition, modern *engineering* is based on technology. Modern technology is computer-based, so algorithms play a central role for

- Mathematical calculations and data processing
- Computer-aided design and manufacturing

- Algorithm-based engineering (networks, control systems)
- Imaging and other medical systems

Engineers and scientists use many of the same tools and approaches. For example, scientists develop computational models and simulations for the purpose of understanding the natural world; engineers develop computational models and simulations for the purpose of designing, building, and controlling they artifacts they create.

Operations research. Researchers and practitioners in OR develop and apply mathematical models for problem solving, including

- Scheduling
- Decision making
- Assignment of resources

The shortest-paths problem of SECTION 4.4 is a classic OR problem. We revisit this problem and consider the *maxflow* problem, illustrate the importance of *reduction*, and discuss implications for general problem-solving models, in particular the *linear programming* model that is central in OR.

ALGORITHMS PLAY AN IMPORTANT ROLE in numerous subfields of computer science with applications in all of these areas, including, but certainly not limited to

- Computational geometry
- Cryptography
- Databases
- Programming languages and systems
- Artificial intelligence

In each field, articulating problems and finding efficient algorithms and data structures for solving them play an essential role. Some of the algorithms we have studied apply directly; more important, the general approach of designing, implementing, and analyzing algorithms that lies at the core of this book has proven successful in all of these fields. This effect is spreading beyond computer science to many other areas of inquiry, from games to music to linguistics to finance to neuroscience.

So many important and useful algorithms have been developed that learning and understanding relationships among them are essential. We finish this section (and this book!) with an introduction to the *theory of algorithms*, with particular focus on *intractability* and the **P=NP?** question that still stands as the key to understanding the practical problems that we aspire to solve.

Event-driven simulation Our first example is a fundamental scientific application: simulate the motion of a system of moving particles that behave according to the laws of elastic collision. Scientists use such systems to understand and predict properties of physical systems. This paradigm embraces the motion of molecules in a gas, the dynamics of chemical reactions, atomic diffusion, sphere packing, the stability of the rings around planets, the phase transitions of certain elements, one-dimensional self-gravitating systems, front propagation, and many other situations. Applications range from molecular dynamics, where the objects are tiny subatomic particles, to astrophysics, where the objects are huge celestial bodies.

Addressing this problem requires a bit of high-school physics, a bit of software engineering, and a bit of algorithmics. We leave most of the physics for the exercises at the end of this section so that we can concentrate on the topic at hand: using a fundamental algorithmic tool (heap-based priority queues) to address an application, enabling calculations that would not otherwise be possible.

Hard-disc model. We begin with an idealized model of the motion of atoms or molecules in a container that has the following salient features:

- Moving *particles* interact via elastic collisions with each other and with *walls*.
- Each particle is a disc with known position, velocity, mass, and radius.
- No other forces are exerted.

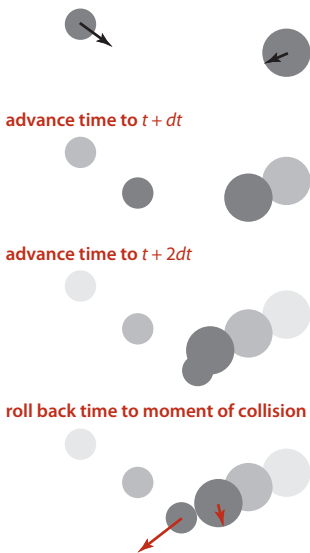

Time-driven simulation

This simple model plays a central role in *statistical mechanics*, a field that relates macroscopic observables (such as temperature and pressure) to microscopic dynamics (such as the motion of individual atoms and molecules). Maxwell and Boltzmann used the model to derive the distribution of speeds of interacting molecules as a function of temperature; Einstein used the model to explain the Brownian motion of pollen grains immersed in water. The assumption that no other forces are exerted implies that particles travel in straight lines at constant speed between collisions. We could also extend the model to add other forces. For example, if we add friction and spin, we can more accurately model the motion of familiar physical objects such as billiard balls on a pool table.

Time-driven simulation. Our primary goal is simply to maintain the model: that is, we want to be able to keep track of the positions and velocities of all the particles as time passes. The basic calculation that we have to do is the following: given the positions and velocities for a specific time t , update them to reflect the situation at

a future time $t+dt$ for a specific amount of time dt . Now, if the particles are sufficiently far from one another and from the walls that no collision will occur before $t+dt$, then the calculation is easy: since particles travel in a straight-line trajectory, we use each particle's velocity to update its position. The challenge is to take the collisions into account. One approach, known as *time-driven simulation*, is based on using a fixed value of dt . To do each update, we need to check all pairs of particles, determine whether or not any two occupy the same position, and then back up to the moment of the first such collision. At that point, we are able to properly update the velocities of the two particles to reflect the collision (using calculations that we will discuss later). This approach is computationally intensive when simulating a large number of particles: if dt is measured in seconds (fractions of a second, usually), it takes time proportional to N^2/dt to simulate an N -particle system for 1 second. This cost is prohibitive (even worse than usual for quadratic algorithms)—in the applications of interest, N is very large and dt is very small. The challenge is that if we make dt too small, the computational cost is high, and if we make dt too large, we may miss collisions.



Event-driven simulation. We pursue an alternative approach that focuses only on those times at which collisions occur. In particular, we are always interested in the *next* collision (because the simple update of all of the particle positions using their velocities is valid until that time). Therefore, we maintain a priority queue of *events*, where an event is a potential collision sometime in the future, either between two particles or between a particle and a wall. The priority associated with each event is its time, so when we *remove the minimum* from the priority queue, we get the next potential collision.

Collision prediction. How do we identify potential collisions? The particle velocities provide precisely the information that we need. For example, suppose that we have, at time t , a particle of radius s at position (r_x, r_y) moving with velocity (v_x, v_y) in the unit box. Consider the vertical wall at $x=1$ with y between 0 and 1. Our interest is in the horizontal component of the motion, so we can concentrate on the x -component of the position r_x and the x -component of the velocity v_x . If v_x is negative, the particle is not on a collision course with the wall, but if v_x is positive, there is a potential collision with the wall. Dividing the horizontal distance to the wall $(1 - s - r_x)$ by the magnitude of the horizontal component of the velocity (v_x) we find that the particle will hit the wall after $dt = (1 - s - r_x)/v_x$ time units, when the particle will be at $(1 - s, r_y + v_y dt)$, unless it hits some other particle or a horizontal wall before that time. Accordingly, we

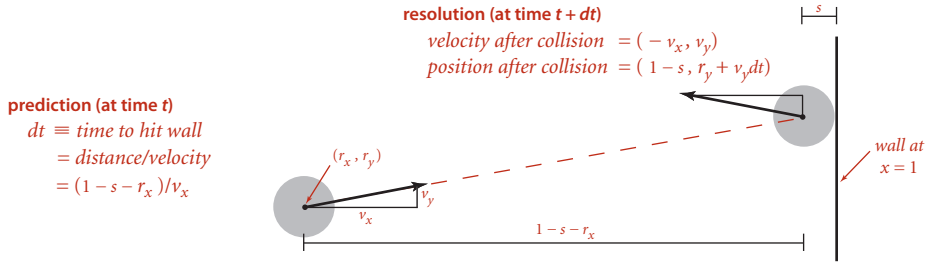

Predicting and resolving a particle-wall collision

put an entry on the priority queue with priority $t + dt$ (and appropriate information describing the particle-wall collision event). The collision-prediction calculations for other walls are similar (see EXERCISE 6.1). The calculation for two particles colliding is also similar, but more complicated. Note that it is often the case that the calculation leads to a prediction that the collision will *not* happen (if the particle is moving away from the wall, or if two particles are moving away from one another)—we do not need to put anything on the priority queue in such cases. To handle another typical situation where the predicted collision might be too far in the future to be of interest, we include a parameter `limit` that specifies the time period of interest, so we can also ignore any events that are predicted to happen at a time later than `limit`.

Collision resolution. When a collision does occur, we need to resolve it by applying the physical formulas that specify the behavior of a particle after an elastic collision with a reflecting boundary or with another particle. In our example where the particle hits the vertical wall, if the collision does occur, the velocity of the particle will change from (v_x, v_y) to $(-v_x, v_y)$ at that time. The collision-resolution calculations for other walls are similar, as are the calculations for two particles colliding, but these are more complicated (see EXERCISE 6.1).

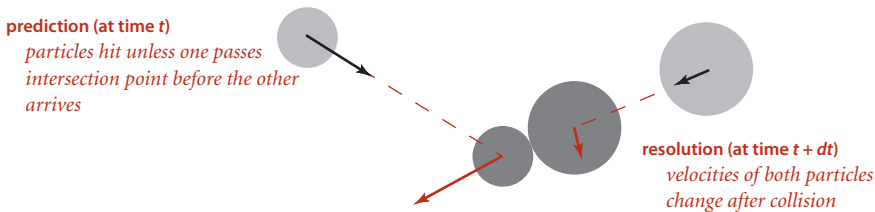

Predicting and resolving a particle-particle collision

Invalidated events. Many of the collisions that we predict do not actually happen because some other collision intervenes. To handle this situation, we maintain an instance variable for each particle that counts the number of collisions in which it has been involved. When we remove an event from the priority queue for processing, we check whether the counts corresponding to its particle(s) have changed since the event was created. This approach to handling invalidated collisions is the so-called *lazy*

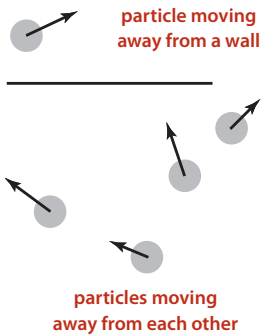

Predictable non-events

approach: when a particle is involved in a collision, we leave the now-invalid events associated with it on the priority queue and essentially ignore them when they come off. An alternative approach, the so-called *eager* approach, is to remove from the priority queue all events involving any colliding particle before calculating all of the new potential collisions for that particle. This approach requires a more sophisticated priority queue (that implements the *remove* operation).

THIS DISCUSSION sets the stage for a full event-driven simulation of particles in motion, interacting according to the physical laws of elastic collisions. The software architecture is to encapsulate the implementation in three classes: a `Particle` data type that encapsulates calculations that involve particles, an `Event` data type for predicted events, and a `CollisionSystem` client that does the simulation. The centerpiece of the simulation is a `MinPQ` that contains events, ordered by time. Next, we consider implementations of `Particle`, `Event`, and `CollisionSystem`.

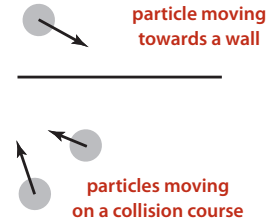

Predictable events

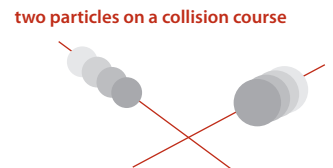

third particle interferes: no collision

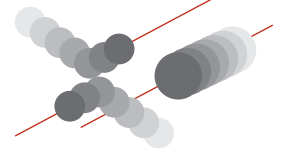

An invalidated event

Particles. EXERCISE 6.1 outlines the implementation of a data type particles, based on a direct application of Newton's laws of motion. A simulation client needs to be able to move particles, draw them, and perform a number of calculations related to collisions, as detailed in the following API:

```
public class Particle
```

Particle()	<i>create a new random particle in unit square</i>
Particle(double rx, double ry, double vx, double vy, double s, double mass)	<i>create a particle with the given position, velocity, radius, and mass</i>
void draw()	<i>draw the particle</i>
void move(double dt)	<i>change position to reflect passage of time dt</i>
int count()	<i>number of collisions involving this particle</i>
double timeToHit(Particle b)	<i>time until this particle hits particle b</i>
double timeToHitHorizontalWall()	<i>time until this particle hits a horizontal wall</i>
double timeToHitVerticalWall()	<i>time until this particle hits a vertical wall</i>
void bounceOff(Particle b)	<i>change particle velocities to reflect collision</i>
void bounceOffHorizontalWall()	<i>change velocity to reflect hitting horizontal wall</i>
void bounceOffVerticalWall()	<i>change velocity to reflect hitting vertical wall</i>

API for moving-particle objects

The three `timeToHit*()` methods all return `Double.POSITIVE_INFINITY` for the (rather common) case when there is no collision course. These methods allow us to predict all future collisions that are associated with a given particle, putting an event on a priority queue corresponding to each one that happens before a given time limit. We use the `bounce()` method each time that we process an event that corresponds to two particles colliding to change the velocities (of both particles) to reflect the collision, and the `bounceOff*()` methods for events corresponding to collisions between a particle and a wall.

Events. We encapsulate in a private class the description of the objects to be placed on the priority queue (events). The instance variable `time` holds the time when the event is predicted to happen, and the instance variables `a` and `b` hold the particles associated with the event. We have three different types of events: a particle may hit a vertical wall, a horizontal wall, or another particle. To develop a smooth dynamic display of the particles in motion, we add a fourth event type, a redraw event that is a command to draw all the particles at their current positions. A slight twist in the implementation of `Event` is that we use the fact that particle values may be null to encode these four different types of events, as follows:

- Neither `a` nor `b` null: particle-particle collision
- `a` not null and `b` null: collision between `a` and a vertical wall
- `a` null and `b` not null: collision between `b` and a horizontal wall
- Both `a` and `b` null: redraw event (draw all particles)

While not the finest object-oriented programming, this convention is a natural one that enables straightforward client code and leads to the implementation shown below.

```
private class Event implements Comparable<Event>
{
    private final double time;
    private final Particle a, b;
    private final int countA, countB;

    public Event(double t, Particle a, Particle b)
    { // Create a new event to occur at time t involving a and b.
        this.time = t;
        this.a = a;
        this.b = b;
        if (a != null) countA = a.count(); else countA = -1;
        if (b != null) countB = b.count(); else countB = -1;
    }

    public int compareTo(Event that)
    {
        if (this.time < that.time) return -1;
        else if (this.time > that.time) return +1;
        else return 0;
    }

    public boolean isValid()
    {
        if (a != null && a.count() != countA) return false;
        if (b != null && b.count() != countB) return false;
        return true;
    }
}
```

Event class for particle simulation

A second twist in the implementation of `Event` is that we maintain the instance variables `countA` and `countB` to record the number of collisions involving each of the particles *at the time the event is created*. If these counts are unchanged when the event is removed from the priority queue, we can go ahead and simulate the occurrence of the event, but if one of the counts changes between the time an event goes on the priority queue and the time it leaves, we know that the event has been invalidated and can ignore it. The method `isValid()` allows client code to test this condition.

Simulation code. With the computational details encapsulated in `Particle` and `Event`, the simulation itself requires remarkably little code, as you can see in the implementation in the class `CollisionSystem` (see page 863 and page 864). Most of the calculations are encapsulated in the `predictCollisions()` method shown on this page. This method

```
private void predictCollisions(Particle a, double limit)
{
    if (a == null) return;
    for (int i = 0; i < particles.length; i++)
    { // Put collision with particles[i] on pq.
        double dt = a.timeToHit(particles[i]);
        if (t + dt <= limit)
            pq.insert(new Event(t + dt, a, particles[i]));
    }
    double dtX = a.timeToHitVerticalWall();
    if (t + dtX <= limit)
        pq.insert(new Event(t + dtX, a, null));
    double dtY = a.timeToHitHorizontalWall();
    if (t + dtY <= limit)
        pq.insert(new Event(t + dtY, null, a));
}
```

Predicting collisions with other particles

calculates all potential future collisions involving particle `a` (either with another particle or with a wall) and puts an event corresponding to each onto the priority queue.

The heart of the simulation is the `simulate()` method shown on page 864. We initialize by calling `predictCollisions()` for each particle to fill the priority queue with the potential collisions involving all particle-wall and all

particle-particle pairs. Then we enter the main event-driven simulation loop, which works as follows:

- Delete the impending event (the one with minimum priority t).
- If the event is invalid, ignore it.
- Advance all particles to time t on a straight-line trajectory.
- Update the velocities of the colliding particle(s).
- Use `predictCollisions()` to predict future collisions involving the colliding particle(s) and insert onto the priority queue an event corresponding to each.

This simulation can serve as the basis for computing all manner of interesting properties of the system, as explored in the exercises. For example, one fundamental property

Event-based simulation of colliding particles (scaffolding)

```

public class CollisionSystem
{
    private class Event implements Comparable<Event>
    { /* See text. */ }

    private MinPQ<Event> pq;          // the priority queue
    private double t = 0.0;          // simulation clock time
    private Particle[] particles;    // the array of particles

    public CollisionSystem(Particle[] particles)
    { this.particles = particles; }

    private void predictCollisions(Particle a, double limit)
    { /* See text. */ }

    public void redraw(double limit, double Hz)
    { // Redraw event: redraw all particles.
      StdDraw.clear();
      for(int i = 0; i < particles.length; i++) particles[i].draw();
      StdDraw.show(20);
      if (t < limit)
          pq.insert(new Event(t + 1.0 / Hz, null, null));
    }

    public void simulate(double limit, double Hz)
    { /* See next page. */ }

    public static void main(String[] args)
    {
        StdDraw.show(0);
        int N = Integer.parseInt(args[0]);
        Particle[] particles = new Particle[N];
        for (int i = 0; i < N; i++)
            particles[i] = new Particle();
        CollisionSystem system = new CollisionSystem(particles);
        system.simulate(10000, 0.5);
    }
}

```

This class is a priority-queue client that simulates the motion of a system of particles over time. The `main()` test client takes a command-line argument N , creates N random particles, creates a `CollisionSystem` consisting of the particles, and calls `simulate()` to do the simulation. The instance variables are a priority queue for the simulation, the time, and the particles.

Event-based simulation of colliding particles (primary loop)

```

public void simulate(double limit, double Hz)
{
    pq = new MinPQ<Event>();
    for (int i = 0; i < particles.length; i++)
        predictCollisions(particles[i], limit);
    pq.insert(new Event(0, null, null)); // Add redraw event.

    while (!pq.isEmpty())
    { // Process one event to drive simulation.
        Event event = pq.deMin();
        if (!event.isValid()) continue;
        for (int i = 0; i < particles.length; i++)
            particles[i].move(event.time - t); // Update particle positions
        t = event.time; // and time.
        Particle a = event.a, b = event.b;
        if (a != null && b != null) a.bounceOff(b);
        else if (a != null && b == null) a.bounceOffHorizontalWall();
        else if (a == null && b != null) b.bounceOffVerticalWall();
        else if (a == null && b == null) redraw(limit, Hz);
        predictCollisions(a, limit);
        predictCollisions(b, limit);
    }
}

```

This method represents the main event-driven simulation. First, the priority queue is initialized with events representing all predicted future collisions involving each particle. Then the main loop takes an event from the queue, updates time and particle positions, and adds new events to reflect changes.

% java CollisonSystem 5

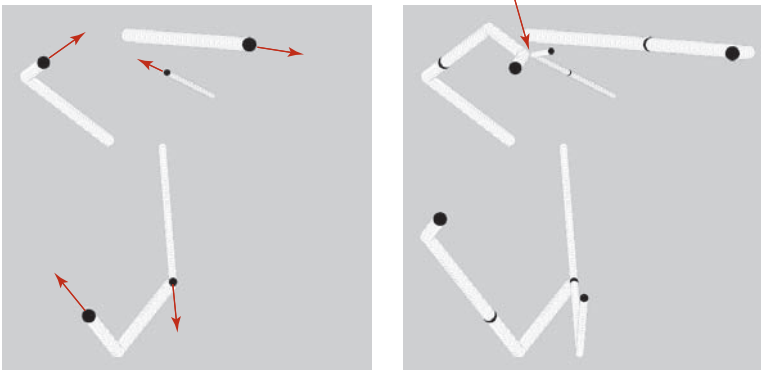

of interest is the amount of pressure exerted by the particles against the walls. One way to calculate the pressure is to keep track of the number and magnitude of wall collisions (an easy computation based on particle mass and velocity) so that we can easily compute the total. Temperature involves a similar calculation.

Performance. As described at the outset, our interest in event-driven simulation is to avoid the computationally intensive inner loop intrinsic in time-driven simulation.

Proposition A. An event-based simulation of N colliding particles requires at most N^2 priority queue operations for initialization, and at most N priority queue operations per collision (with one extra priority queue operation for each invalid collision).

Proof Immediate from the code.

Using our standard guaranteed-logarithmic-time-per operation priority-queue implementation from SECTION 2.4, the time needed per collision is linearithmic. Simulations with large numbers of particles are therefore quite feasible.

EVENT-DRIVEN SIMULATION applies to countless other domains that involve physical modeling of moving objects, from molecular modeling to astrophysics to robotics. Such applications may involve extending the model to add other kinds of bodies, to operate in three dimensions, to include other forces, and in many other ways. Each extension involves its own computational challenges. This event-driven approach results in a more robust, accurate, and efficient simulation than many other alternatives that we might consider, and the efficiency of the heap-based priority queue enables calculations that might not otherwise be possible.

Simulation plays a vital role in helping researchers to understand properties of the natural world in all fields of science and engineering. Applications ranging from manufacturing processes to biological systems to financial systems to complex engineered structures are too numerous to even list here. For a great many of these applications, the extra efficiency afforded by the heap-based priority queue data type or an efficient sorting algorithm can make a substantial difference in the quality and extent that are possible in the simulation.

B-trees In CHAPTER 3, we saw that algorithms that are appropriate for accessing items from huge collections of data are of immense practical importance. Searching is a fundamental operation on huge data sets, and such searching consumes a significant fraction of the resources used in many computing environments. With the advent of the web, we have the ability to access a vast amount of information that might be relevant to a task—our challenge is to be able to search through it efficiently. In this section, we describe a further extension of the balanced-tree algorithms from SECTION 3.3 that can support *external search* in symbol tables that are kept on a disk or on the web and are thus potentially far larger than those we have been considering (which have to fit in addressable memory). Modern software systems are blurring the distinction between local files and web pages, which may be stored on a remote computer, so the amount of data that we might wish to search is virtually unlimited. Remarkably, the methods that we shall study can support search and insert operations on symbol tables containing trillions of items or more using only four or five references to small blocks of data.

Cost model. Data storage mechanisms vary widely and continue to evolve, so we use a simple model to capture the essentials. We use the term *page* to refer to a contiguous block of data and the term *probe* to refer to the first access to a page. We assume that accessing a page involves reading its contents into local memory, so that subsequent accesses are relatively inexpensive. A page could be a file on your local computer or a web page on a distant computer or part of a file on a server, or whatever. Our goal is to develop search implementations that use a small number of probes to find any given key. We avoid making specific assumptions about the page size and about the ratio of the time required for a probe (which presumably requires communicating with a distant device) to the time required, subsequently, to access items within the block (which presumably happens in a local processor). In typical situations, these values are likely to be on the order of 100 or 1,000 or 10,000; we do not need to be more precise because the algorithms are not highly sensitive to differences in the values in the ranges of interest.

B-tree cost model. When studying algorithms for external searching, we count *page accesses* (the number of times a page is accessed, for read or write).

B-trees. The approach is to extend the 2-3 tree data structure described in SECTION 3.3, with a crucial difference: rather than store the data in the tree, we build a tree with *copies* of the keys, each key copy associated with a link. This approach enables us to more easily separate the index from the table itself, much like the index in a book. As with 2-3 trees, we enforce upper and lower bounds on the number of key-link pairs

that can be in each node: we choose a parameter M (an even number, by convention) and build multiway trees where every node must have *at most* $M - 1$ key-link pairs (we assume that M is sufficiently small that an M -way node will fit on a page) and *at least* $M/2$ key-link pairs (to provide the branching that we need to keep search paths short), except possibly the root, which can have fewer than $M/2$ key-link pairs but must have at least 2. Such trees were named *B-trees* by Bayer and McCreight, who, in 1970, were the first researchers to consider the use of multiway balanced trees for external searching. Some people reserve the term *B-tree* to describe the exact data structure built by the algorithm suggested by Bayer and McCreight; we use it as a generic term for data structures based on multiway balanced search trees with a fixed page size. We specify the value of M by using the terminology “*B-tree of order M .*” In a B-tree of order 4, each node has at most 3 and at least 2 key-link pairs; in a B-tree of order 6, each node has at most 5 and at least 3 link pairs (except possibly the root, which could have 2 key-link pairs), and so forth. The reason for the exception at the root for larger M will become clear when we consider the construction algorithm in detail.

Conventions. To illustrate the basic mechanisms, we consider an (ordered) SET implementation (with keys and no values). Extending to provide an ordered ST to associate keys with values is an instructive exercise (see EXERCISE 6.16). Our goal is to support `add()` and `contains()` for a set of keys that could be huge. We use ordered keys because we are generalizing search trees, which are based on ordered keys. Extending our implementation to support other ordered operations is also an instructive exercise. In external searching applications, it is common to keep the index separate from the data. For B-trees, we do so by using two different kinds of nodes:

- *Internal nodes*, which associate copies of keys with pages
- *External nodes*, which have references to the actual data

Every key in an internal node is associated with another node that is the root of a tree containing all keys *greater than or equal to* that key and *less than* the next largest key, if

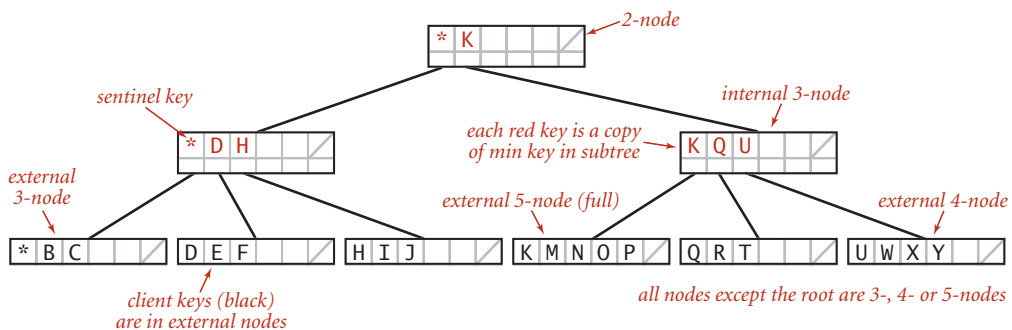

Anatomy of a B-tree set ($M = 6$)

any. It is convenient to use a special key, known as a *sentinel*, that is defined to be less than all other keys, and to start with a root node containing that key, associated with the tree containing all the keys. The symbol table does not contain duplicate keys, but we use copies of keys (in internal nodes) to guide the search. (In our examples, we use single-letter keys and the character `*` as the sentinel that is less than all other keys.) These conventions simplify the code somewhat and thus represent a convenient (and widely used) alternative to mixing all the data with links in the internal nodes, as we have done for other search trees.

Search and insert. Search in a B-tree is based on recursively searching in the unique subtree that could contain the search key. Every search ends in an external node that contains the key if and only if it is in the set. We might also terminate a *search hit* when encountering a copy of the search key in an internal node, but we always search to an external node because doing so simplifies extending the code to an ordered symbol-table implementation (also, this event rarely happens when M is large). To be specific, consider searching in a B-tree of order 6: it consists of 3-nodes with 3 key-link pairs, 4-nodes with 4 key-link pairs, and 5-nodes with 5 key-link pairs, with possibly a 2-node at the root. To search, we start at the root and move from one node to the next by finding the proper interval for the search key in the current node and then exiting through the corresponding link to get to the next node. Eventually, the search process leads us to a page containing keys at the bottom of the tree. We terminate the search with a search hit if the search key is in that page; we terminate with a search miss if it is not. As with 2-3 trees, we can use recursive code to insert a new key at the bottom of the tree. If there is no room for the key, we allow the node at the bottom to temporarily overflow (become a 6-node) and then split 6-nodes on the way up the tree, after the recursive call. If the root is an 6-node, we split it into a 2-node connected to two 3-nodes; elsewhere in the tree, we replace any k -node attached to a 6-node by a $(k+1)$ -node attached to two 3-nodes. Replacing 3 by $M/2$ and 6 by M in this description converts it into a description of search and insert for B-trees of order M and leads to the following definition:

Definition. A B-tree of order M (where M is an even positive integer) is a tree that either is an external k -node (with k keys and associated information) or comprises internal k -nodes (each with k keys and k links to B-trees representing each of the k intervals delimited by the keys), having the following structural properties: every path from the root to an external node must be the same length (perfect balance); and k must be between 2 and $M - 1$ at the root and between $M/2$ and $M - 1$ at every other node.

searching for E

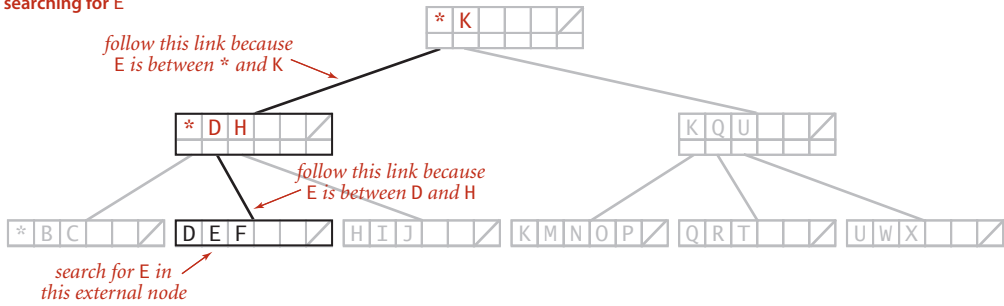

Searching in a B-tree set (M = 6)

inserting A

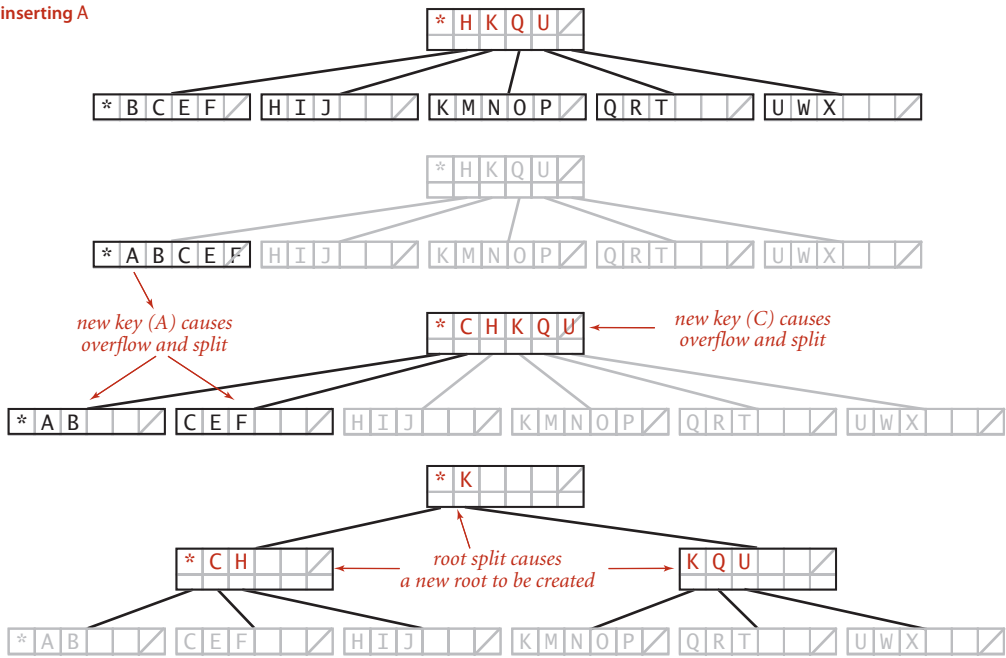

Inserting a new key into a B-tree set

Representation. As just discussed, we have a great deal of freedom in choosing concrete representations for nodes in B-trees. We encapsulate these choices in a Page API that associates keys with links to Page objects and supports the operations that we need to test for overfull pages, split them, and distinguish between internal and external pages. You can think of a Page as a symbol table, kept externally (in a file on your computer or on the web). The terms *open* and *close* in the API refer to the process of bringing an external page into internal memory and writing its contents back out (if necessary). The `put()` method for internal pages is a symbol-table operation that associates the given page with the minimum key in the tree rooted at that page. The `put()` and `contains()` methods for external pages are like their corresponding SET operations. The workhorse of any implementation is the `split()` method, which splits a full page by moving the $M/2$ key-value pairs of rank greater than $M/2$ to a new Page and returns a reference to that page. EXERCISE 6.15 discusses an implementation of Page using BinarySearchST, which implements B-trees in memory, like our other search implementations. On some systems, this might suffice as an external searching implementation because a virtual-memory system might take care of disk references. More typical practical implementations might involve hardware-specific code that reads and

```
public class Page<Key>

---

    Page(boolean bottom) create and open a page
    void close() close a page
    void add(Key key) put key into the (external) page
    void add(Page p) open p and put an entry into this
                    (internal) page that associates the
                    smallest key in p with p
    boolean isExternal() is this page external?
    boolean contains(Key key) is key in the page?
    Page next(Key key) the subtree that could contain the key
    boolean isFull() has the page overflowed?
    Page split() move the highest-ranking half of the
                keys in the page to a new page
    Iterable<Key> keys() iterator for the keys on the page
```

API for a B-tree page

writes pages. EXERCISE 6.19 encourages you to think about implementing Page using web pages. We ignore such details here in the text to emphasize the utility of the B-tree concept in a broad variety of settings.

With these preparations, the code for BTreeSET on page 872 is remarkably simple. For contains(), we use a recursive method that takes a Page as argument and handles three cases:

- If the page is external and the key is in the page, return true.
- If the page is external and the key is not in the page, return false.
- Otherwise, do a recursive call for the subtree that could contain the key.

For put() we use the same recursive structure, but insert the key at the bottom if it is not found during the search and then split any full nodes on the way up the tree.

Performance. The most important property of B-trees is that for reasonable values of the parameter M the search cost is *constant*, for all practical purposes:

Proposition B. A search or an insertion in a B-tree of order M with N items requires between $\log_M N$ and $\log_{M/2} N$ probes—a constant number, for practical purposes.

Proof This property follows from the observation that all the nodes in the interior of the tree (nodes that are not the root and are not external) have between $M/2$ and $M - 1$ links, since they are formed from a split of a full node with M keys and can only grow in size (when a child is split). In the best case, these nodes form a complete tree of branching factor $M - 1$, which leads immediately to the stated bound. In the worst case, we have a root with two entries each of which refers to a complete tree of degree $M/2$. Taking the logarithm to the base M results in a very small number—for example, when M is 1,000, the height of the tree is less than 4 for N less than 62.5 billion.

In typical situations, we can reduce the cost by one probe by keeping the root in internal memory. For searching on disk or on the web, we might take this step explicitly before embarking on any application involving a huge number of searches; in a virtual memory with caching, the root node will be the one most likely to be in fast memory, because it is the most frequently accessed node.

Space. The space usage of B-trees is also of interest in practical applications. By construction, the pages are at least half full, so, in the worst case, B-trees use about double the space that is absolutely necessary for keys, plus extra space for links. For random keys, A. Yao proved in 1979 (using mathematical analysis that is beyond the scope of

ALGORITHM 6.12 B-tree set implementation

```

public class BTreeSET<Key extends Comparable<Key>>
{
    private Page root = new Page(true);
    public BTreeSET(Key sentinel)
    { put(sentinel); }
    public boolean contains(Key key)
    { return contains(root, key); }
    private boolean contains(Page h, Key key)
    {
        if (h.isExternal()) return h.contains(key);
        return contains(h.next(key), key);
    }
    public void add(Key key)
    {
        put (root, key);
        if (root.isFull())
        {
            Page lefthalf = root;
            Page righthalf = root.split();
            root = new Page(false);
            root.put(lefthalf);
            root.put(righthalf);
        }
    }
    public void add(Page h, Key key)
    {
        if (h.isExternal()) { h.put(key); return; }
        Page next = h.next(key);
        put(next, key);
        if (next.isFull())
            h.put(next.split());
        next.close();
    }
}

```

This B-tree implementation implements multiway balanced search trees as described in the text, using a Page data type that supports search by associating keys with subtrees that could contain the key and supports insertion by including a test for overflow and a page split method.

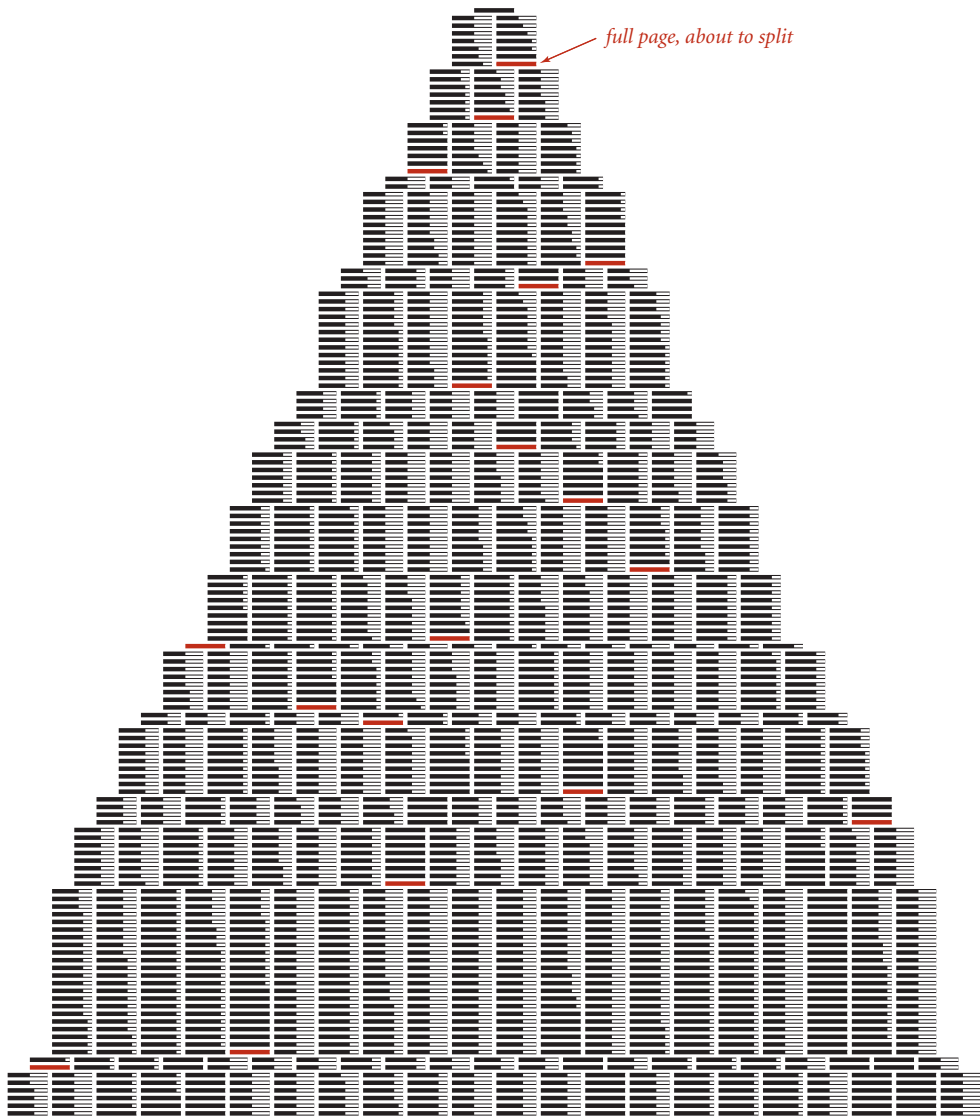

Building a large B-tree

this book) that the average number of keys in a node is about $M \ln 2$, so about 44 percent of the space is unused. As with many other search algorithms, this random model reasonably predicts results for key distributions that we observe in practice.

THE IMPLICATIONS OF PROPOSITION B ARE PROFOUND and worth contemplating. Would you have guessed that you can develop a search implementation that can guarantee a cost of four or five probes for search and insert in files as large as you can reasonably contemplate needing to process? B-trees are widely used because they allow us to achieve this ideal. In practice, the primary challenge to developing an implementation is ensuring that space is available for the B-tree nodes, but even that challenge becomes easier to address as available storage space increases on typical devices.

Many variations on the basic B-tree abstraction suggest themselves immediately. One class of variations saves time by packing as many page references as possible in internal nodes, thereby increasing the branching factor and flattening the tree. Another class of variations improves storage efficiency by combining nodes with siblings before splitting. The precise choice of variant and algorithm parameter can be engineered to suit particular devices and applications. Although we are limited to getting a small constant factor improvement, such an improvement can be of significant importance for applications where the table is huge and/or huge numbers of transactions are involved, precisely the applications for which B-trees are so effective.

Suffix arrays Efficient algorithms for string processing play a critical role in commercial applications and in scientific computing. From the countless strings that define web pages that are searched by billions of users to the extensive genomic databases that scientists are studying to unlock the secret of life, computing applications of the 21st century are increasingly string-based. As usual, some classic algorithms are effective, but remarkable new algorithms are being developed. Next, we describe a data structure and an API that support some of these algorithms. We begin by describing a typical (and a classic) string-processing problem.

Longest repeated substring. What is the longest substring that appears at least twice in a given string? For example, the longest repeated substring in the string "to be or not to be" is the string "to be". Think briefly about how you might solve it. Could you find the longest repeated substring in a string that has millions of characters? This problem is simple to state and has many important applications, including data compression, cryptography, and computer-assisted music analysis. For example, a standard technique used in the development of large software systems is *refactoring code*. Programmers often put together new programs by cutting and pasting code from old programs. In a large program built over a long period of time, replacing duplicate code by function calls to a single copy of the code can make the program much easier to understand and maintain. This improvement can be accomplished by finding long repeated substrings in the program. Another application is found in computational biology. Are substantial identical fragments to be found within a given genome? Again, the basic computational problem underlying this question is to find the longest repeated substring in a string. Scientists are typically interested in more detailed questions (indeed, the nature of the repeated substrings is precisely what scientists seek to understand), but such questions are certainly no easier to answer than the basic question of finding the longest repeated substring.

Brute-force solution. As a warmup, consider the following simple task: given two strings, find their longest common *prefix* (the longest substring that is a prefix of both strings). For example, the longest common prefix of `acctgttaac` and `accgtaa` is `acc`. The code at right is a useful starting point for addressing more complicated tasks: it takes time proportional to the length of the match. Now, how do we find the longest repeated substring in a given string? With `lcp()`, the following

```
private static int lcp(String s, String t)
{
    int N = Math.min(s.length(), t.length());
    for (int i = 0; i < N; i++)
        if (s.charAt(i) != t.charAt(i)) return i;
    return N;
}
```

Longest common prefix of two strings

brute-force solution immediately suggests itself: we compare the substring starting at each string position i with the substring starting at each other starting position j , keeping track of the longest match found. This code is not useful for long strings, because its running time is at least *quadratic* in the length of the string: as usual, the number of different pairs i and j is $N(N-1)/2$, so the number of calls on `lcp()` for this approach would be $\sim N^2/2$. Using this solution for a genomic sequence with millions of characters would require trillions of `lcp()` calls, which is infeasible.

Suffix sort solution. The following clever approach, which takes advantage of sorting in an unexpected way, is an effective way to find the longest repeated substring, even in a huge string: we use Java's `substring()` method to make an array of strings that consists of the suffixes of `s` (the substrings starting at each position and going to the end), and then we sort this array. The key to the algorithm is that every substring appears somewhere as a prefix of one of the suffixes in the array. After sorting, the longest repeated substrings will appear in adjacent positions in the array. Thus, we can make a single pass through the sorted array, keeping track of the longest matching prefixes between adjacent strings. This approach is significantly more efficient than the brute-force method, but before implementing and analyzing it, we consider another application of suffix sorting.

```

input string
 0 1 2 3 4 5 6 7 8 9 10 11 12 13 14
  a a c a a g t t t a c a a g c

suffixes
0 a a c a a g t t t a c a a g c
1 a c a a g t t t a c a a g c
2 c a a g t t t a c a a g c
3 a a g t t t a c a a g c
4 a g t t t a c a a g c
5 g t t t a c a a g c
6 t t t a c a a g c
7 t t a c a a g c
8 t a c a a g c
9 a c a a g c
10 c a a g c
11 a a g c
12 a g c
13 g c
14 c

sorted suffixes
0 a a c a a g t t t a c a a g c
11 a a g c
3 a a g t t t a c a a g c
9 a c a a g c
1 a c a a g t t t a c a a g c
12 a g c
4 a g t t t a c a a g c
14 c
10 c a a g c
2 c a a g t t t a c a a g c
13 g c
5 g t t t a c a a g c
8 t a c a a g c
7 t t a c a a g c
6 t t t a c a a g c

longest repeated substring
 1           9
  a a c a a g t t t a c a a g c

```

Computing the LRS by sorting suffixes

Indexing a string. When you are trying to find a particular substring within a large text—for example, while working in a text editor or within a page you are viewing with a browser—you are doing a *substring search*, the problem we considered in SECTION 5.3. For that problem, we assume the text to be relatively large and focus on preprocessing the *substring*, with the goal of being able to efficiently find that substring in any given text. When you type search keys into your web browser, you are doing a *search with string keys*, the subject of SECTION 5.2. Your search engine must precompute an index, since it cannot afford to scan all the pages in the web for your keys. As we discussed in SECTION 3.5 (see FileIndex on page 501), this would ideally be an inverted index associating each possible search string with all web pages that contain it—a symbol table where each entry is a string key and each value is a set of pointers (each pointer giving the information necessary to locate an occurrence of the key on the web—perhaps a URL that names a web page and an integer offset within that page). In practice, such a symbol table would be far too big, so your search engine uses various sophisticated algorithms to reduce its size. One approach is to rank web pages by importance (perhaps using an algorithm like the PageRank algorithm that we discussed on page 507) and work only with highly-ranked pages, not all pages. Another approach to cutting down on the size

*symbol-table search with string keys:
find the pages containing the key*

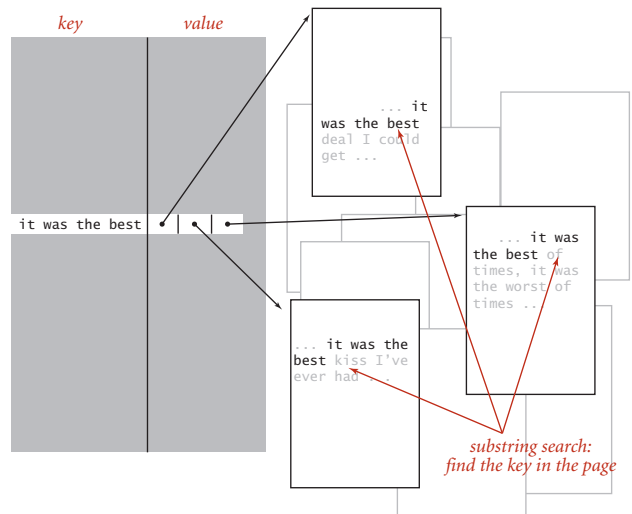

Idealized view of a typical web search

of a symbol table to support search with string keys is to associate URLs with *words* (substrings delimited by whitespace) as keys in the precomputed index. Then, when you search for a word, the search engine can use the index to find the (important) pages containing your search keys (words) and then use substring search within each page to find them. But with this approach, if the text were to contain "everything" and you were to search for "thing", you would not find it. For some applications, it is worthwhile to build an index to help find *any substring* within a given text. Doing so might be justified for a linguistic study of an important piece of literature, for a genomic sequence that might be an object of study for many scientists, or just for a widely

accessed web page. Again, ideally, the index would associate all possible substrings of the text string with each position where it occurs in the text string, as depicted at right. The basic problem with this ideal is that the number of possible substrings is too large to have a symbol-table entry for each of them (an N -character text has $N(N-1)/2$ substrings). The table for the example at right would need entries for b, be, bes, best, best o, best of, e, es, est, est o, est of, s, st, st o, st of, t, t o, t of, o, of, and many, many other substrings. Again, we can use a suffix sort to address this problem in a manner analogous to our first symbol-table implementation using binary search, in SECTION 3.1. We consider each of the N suffixes to be keys, create a sorted array of our keys (the suffixes), and use binary search to search in that array, comparing the search key with each suffix.

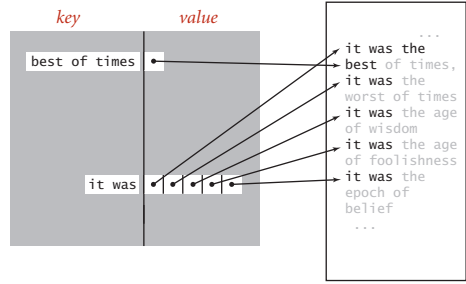

Idealized view of a text-string index

suffixes		sorted suffix array		
		<i>i</i>	<i>index(i)</i>	<i>lcp(i)</i>
0	it was the best of times it was the	0	10	0
1	t was the best of times it was the	1	24	1
2	was the best of times it was the	2	15	1
3	was the best of times it was the	3	31	1
4	as the best of times it was the	4	6	4
5	s the best of times it was the	5	18	2
6	the best of times it was the	6	27	1
7	the best of times it was the	7	2	8
8	he best of times it was the	8	29	0
9	e best of times it was the	9	4	6
10	best of times it was the	10	11	0
11	best of times it was the	11	34	0
12	est of times it was the	12	9	1
13	st of times it was the	13	22	1
14	t of times it was the	14	12	2
15	of times it was the	15	17	0
16	of times it was the	16	33	0
17	f times it was the	17	8	2
18	times it was the	18	20	0
19	times it was the	19	25	1
20	imes it was the	20	0	10
21	mes it was the	21	21	0
22	es it was the	22	16	0
23	s it was the	23	23	0
24	it was the	24	30	2
25	it was the	25	5	5
26	t was the	26	13	1
27	was the	27	14	0
28	was the	28	26	2
29	as the	29	1	9
30	s the	30	32	1
31	the	31	7	3
32	the	32	19	1
33	he	33	28	0
34	e	34	3	7

best of times it was the			
it was the			
of times it was the			
the			
the best of times it was the			
times it was the			
was the			
was the best of times it was the			
as the			
as the best of times it was the	← select(9)		
best of times it was the			
e			
e best of times it was the			
es it was the			
est of times it was the			
f times it was the			
he			
he best of times it was the			
imes it was the			
it was the			
it was the best of times it was the			
mes it was the			
of times it was the			
s it was the			
s the			
s the best of times it was the			
st of times it was the			
t of times it was the			
t was the			
t was the best of times it was the			
the			
the best of times it was the			
times it was the			
was the			
was the best of times it was the			

index(9) →

lcp(20) →

rank("th") →

intervals containing "th" found by rank() during binary search

Binary search in a suffix array

API and client code. To support client code to solve these two problems, we articulate the API shown below. It includes a constructor; a `length()` method; methods `select()` and `index()`, which give the string and index of the suffix of a given rank in the sorted list of suffixes; a method `lcp()` that gives the length of the longest common prefix of each suffix and the one preceding it in the sorted list; and a method `rank()` that gives the number of suffixes less than the given key (just as we have been using since we first examined binary search in CHAPTER 1). We use the term *suffix array* to describe the abstraction of a sorted list of suffix strings, without necessarily committing to use an array of strings as the underlying data structure.

```
public class SuffixArray
    SuffixArray(String text) build suffix array for text
    int length() length of text
    String select(int i) i th in the suffix array
                        (i between 0 and N-1)
    int index(int i) index of select(i) (i between 0 and N-1)
    int lcp(int i) length of longest common prefix of select(i)
                  and select(i-1) (i between 1 and N-1)
    int rank(String key) number of suffixes less than key
```

Suffix array API

In the example on the facing page, `select(9)` is "as the best of times...", `index(9)` is 4, `lcp(20)` is 10 because "it was the best of times..." and "it was the" have the common prefix "it was the" which is of length 10, and `rank("th")` is 30. Note also that the `select(rank(key))` is the first possible suffix in the sorted suffix list that has key as prefix and that all other occurrences of key in the text immediately follow (see the figure on the opposite page). With this API, the client code on the next two pages is immediate. LRS (page 880) finds the longest repeated substring in the text on standard input by building a suffix array and then scanning through the sorted suffixes to find the maximum `lcp()` value. KWIC (page 881) builds a suffix array for the text named as command-line argument, takes queries from standard input, and prints all occurrences of each query in the text (including a specified number of characters before and after to give context). The name KWIC stands for *keyword-in-context* search, a term dating at least to the 1960s. The simplicity and efficiency of this client code for these typical string-processing applications is remarkable, and testimony to the importance of careful API design (and the power of a simple but ingenious idea).

```
public class LRS
{
    public static void main(String[] args)
    {
        String text = StdIn.readAll();
        int N = text.length();
        SuffixArray sa = new SuffixArray(text);
        String lrs = "";
        for (int i = 1; i < N; i++)
        {
            int length = sa.lcp(i);
            if (length > substring.length())
                lrs = sa.select(i).substring(0, length);
        }
        StdOut.println(lrs);
    }
}
```

Longest repeated substring client

```
% more tinyTale.txt
it was the best of times it was the worst of times
it was the age of wisdom it was the age of foolishness
it was the epoch of belief it was the epoch of incredulity
it was the season of light it was the season of darkness
it was the spring of hope it was the winter of despair

% java LRS < tinyTale.txt
st of times it was the
```

```
public class KWIC
{
    public static void main(String[] args)
    {
        In in = new In(args[0]);
        int context = Integer.parseInt(args[1]);

        String text = in.readAll().replaceAll("\\s+", " ");
        int N = text.length();
        SuffixArray sa = new SuffixArray(text);

        while (StdIn.hasNextLine())
        {
            String q = StdIn.readLine();
            for (int i = sa.rank(q); i < N && sa.select(i).startsWith(q); i++)
            {
                int from = Math.max(0, sa.index(i) - context);
                int to = Math.min(N-1, from + q.length() + 2*context);
                StdOut.println(text.substring(from, to));
            }
            StdOut.println();
        }
    }
}
```

Keyword-in-context indexing client

```
% java KWIC tale.txt 15
search
o st giless to search for contraband
her unavailing search for your fathe
le and gone in search of her husband
t provinces in search of impoverishe
dispersing in search of other carri
n that bed and search the straw hold

better thing
t is a far far better thing that i do than
some sense of better things else forgotte
was capable of better things mr carton ent
```

Implementation. The code on the facing page is a straightforward implementation of the `SuffixArray` API. Its instance variables are an array of strings and (for economy in code) a variable `N` that holds the length of the array (the length of the string and its number of suffixes). The constructor builds the suffix array and sorts it, so `select(i)` just returns `suffixes[i]`. The implementation of `index()` is also a one-liner, but it is a bit tricky, based on the observation that *the length of the suffix string uniquely determines its starting point*. The suffix of length `N` starts at position 0, the suffix of length `N-1` starts at position 1, the suffix of length `N-2` starts at position 2, and so forth, so `index(i)` just returns `N - suffixes[i].length()`. The implementation of `lcp()` is immediate, given the static method `lcp()` on page 875, and `rank()` is virtually the same as our implementation of binary search for symbol tables, on page 381. Again, the simplicity and elegance of this implementation should not mask the fact that it is a sophisticated algorithm that enables solution of important problems like the longest repeated substring problem that would otherwise seem to be infeasible.

Performance. The efficiency of suffix sorting depends on the fact that Java substring extraction uses a constant amount of space—each substring is composed of standard object overhead, a pointer into the original, and a length. Thus, the size of the index is linear in the size of the string. This point is a bit counterintuitive because the total number of characters in the suffixes is $\sim N^2/2$, a quadratic function of the size of the string. Moreover, that quadratic factor gives one pause when considering the cost of sorting the suffix array. It is very important to bear in mind that this approach is effective for long strings because of the Java representation for strings: when we exchange two strings, we are exchanging only references, not the whole string. Now, the cost of *comparing* two strings may be proportional to the length of the strings in the case when their common prefix is very long, but most comparisons in typical applications involve only a few characters. If so, the running time of the suffix sort is linearithmic. For example, in many applications, it is reasonable to use a random string model:

Proposition C. Using 3-way string quicksort, we can build a suffix array from a random string of length N with space proportional to N and $\sim 2N \ln N$ character compares, on the average.

Discussion: The space bound is immediate, but the time bound follows from a detailed and difficult research result by P. Jacquet and W. Szpankowski, which implies that the cost of sorting the suffixes is asymptotically the same as the cost of sorting N random strings (see PROPOSITION E on page 723).

ALGORITHM 6.13 Suffix array (elementary implementation)

```
public class SuffixArray
{
    private final String[] suffixes; // suffix array
    private final int N;           // length of string (and array)

    public SuffixArray(String s)
    {
        N = s.length();
        suffixes = new String[N];
        for (int i = 0; i < N; i++)
            suffixes[i] = s.substring(i);
        Quick3way.sort(suffixes);
    }

    public int length()           { return N; }
    public String select(int i)   { return suffixes[i]; }
    public int index(int i)       { return N - suffixes[i].length(); }

    private static int lcp(String s, String t)
    // See page page 875.

    public int lcp(int i)
    { return lcp(suffixes[i], suffixes[i-1]); }

    public int rank(String key)
    { // binary search
        int lo = 0, hi = N - 1;
        while (lo <= hi)
        {
            int mid = lo + (hi - lo) / 2;
            int cmp = key.compareTo(suffixes[mid]);
            if (cmp < 0) hi = mid - 1;
            else if (cmp > 0) lo = mid + 1;
            else return mid;
        }
        return lo;
    }
}
```

This implementation of our `SuffixArray` API depends for its efficiency on the fact that Java `String` values are immutable, so that substrings are constant-size references and substring extraction takes constant time (see text).

Improved implementations. Our elementary implementation of SuffixArray has poor worst-case performance. For example, if all the characters are equal, the sort examines every character in each substring and thus takes *quadratic* time. For strings of the type we have been using as examples, such as genomic sequences or natural-language text, this is not likely to be problematic, but the algorithm can be slow for texts with long runs of identical characters. Another way of looking at the problem is to observe that the cost of finding the longest repeated substring is *quadratic in the length of the substring* because all of the prefixes of the repeat need to be checked (see the diagram at right). This is not a problem for a text such as *A Tale of Two Cities*, where the longest repeat

"s dropped because it would have
been a bad thing for me in a
worldly point of view i"

has just 84 characters, but it is a serious problem for genomic data, where long repeated substrings are not unusual. How can this quadratic behavior for repeat searching be avoided? Remarkably, research by P. Weiner in 1973 showed that *it is possible to solve the longest repeated substring problem in guaranteed linear time*. Weiner's algorithm was based on building a suffix tree data structure (essentially a trie for suffixes). With multiple pointers per character, suffix trees consume too much space for many practical problems, which led to the development of suffix arrays. In the 1990s, U. Manber and E. Myers presented a linearithmic algorithm for building suffix arrays directly and a method that does preprocessing at the same time as the suffix sort to support *constant-time* $\lceil \log C \rceil$. Several linear-time suffix sorting algorithms have been developed since. With a bit more work, the Manber-Myers implementation can also support a two-argument $\lceil \log C \rceil$ that finds the longest common prefix of two given suffixes that are not necessarily adjacent in guaranteed constant time, again a remarkable improvement over the straightforward implementation. These results are quite surprising, as they achieve efficiencies quite beyond what you might have expected.

input string
a a c a a g t t t a c a a g c

suffixes of longest repeat (M = 5)

```

a c a a g
c a a g
a a g
a g
g

```

← all appear at least twice as a prefix of a suffix string

sorted suffixes of input

```

a a c a a g t t t a c a a g c
3 a a g c
5 a c a a g c
2 a c a a g t t t a c a a g c
2 a g c
c
4 c a a g c
c a a g t t t a c a a g c
1 g c
g t t t a c a a g c
t a c a a g c
t t a c a a g c
t t t a c a a g c

```

comparison cost is at least
 $1 + 2 + \dots + M \sim M^2/2$

LRS cost is quadratic in repeat length

Proposition D. With suffix arrays, we can solve both the suffix sorting and longest repeated substring problems in linear time.

Proof: The remarkable algorithms for these tasks are just beyond our scope, but you can find on the booksite code that implements the `SuffixArray` constructor in linear time and `lcp()` queries in constant time.

A `SuffixArray` implementation based on these ideas supports efficient solutions of numerous string-processing problems, with simple client code, as in our LRS and KWIC examples.

SUFFIX ARRAYS ARE THE CULMINATION of decades of research that began with the development of tries for KWIC indices in the 1960s. The algorithms that we have discussed were worked out by many researchers over several decades in the context of solving practical problems ranging from putting the *Oxford English Dictionary* online to the development of the first web search engines to sequencing the human genome. This story certainly helps put the importance of algorithm design and analysis in context.

Network-flow algorithms Next, we consider a graph model that has been successful not just because it provides us with a simply stated problem-solving model that is useful in many practical applications but also because we have efficient algorithms for solving problems within the model. The solution that we consider illustrates the tension between our quest for implementations of general applicability and our quest for efficient solutions to specific problems. The study of network-flow algorithms is fascinating because it brings us tantalizingly close to compact and elegant implementations that achieve both goals. As you will see, we have straightforward implementations that are guaranteed to run in time proportional to a polynomial in the size of the network.

The classical solutions to network-flow problems are closely related to other graph algorithms that we studied in CHAPTER 4, and we can write surprisingly concise programs that solve them, using the algorithmic tools we have developed. As we have seen in many other situations, good algorithms and data structures can lead to substantial reductions in running times. Development of better implementations and better algorithms is still an area of active research, and new approaches continue to be discovered.

A physical model. We begin with an idealized physical model in which several of the basic concepts are intuitive. Specifically, imagine a collection of interconnected oil pipes of varying sizes, with switches controlling the direction of flow at junctions, as in the example illustrated at right. Suppose further that the network has a single *source* (say, an oil field) and a single *sink* (say, a large refinery) to which all the pipes ultimately connect. At each vertex, the flowing oil reaches an equilibrium where the amount of oil flowing in is equal to the amount flowing out. We measure both flow and pipe capacity in the same units (say, gallons per second). If every switch has the property that the total capacity of the ingoing pipes is equal to the total capacity of the outgoing pipes, then there is no problem to solve: we

add 2 units of flow
along $0 \rightarrow 1 \rightarrow 3 \rightarrow 5$

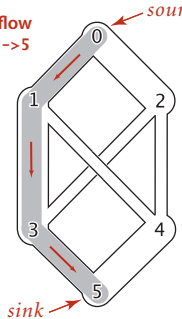

add 1 unit of flow
along $0 \rightarrow 2 \rightarrow 4 \rightarrow 5$

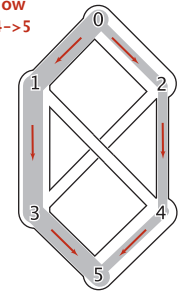

redirect 1 unit of flow
from $1 \rightarrow 3 \rightarrow 5$
to $1 \rightarrow 4 \rightarrow 5$

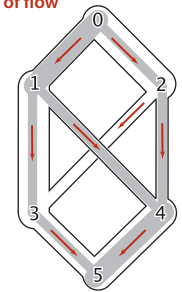

add 1 unit of flow
along $0 \rightarrow 2 \rightarrow 3 \rightarrow 5$

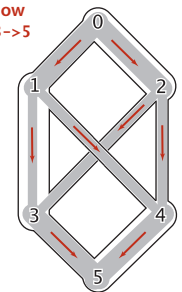

Adding flow to a network

simply fill all pipes to full capacity. Otherwise, not all pipes are full, but oil flows through the network, controlled by switch settings at the junctions, satisfying a *local equilibrium* condition at the junctions: the amount of oil flowing into each junction is equal to the amount of oil flowing out. For example, consider the network in the diagram on the opposite page. Operators might start the flow by opening the switches along the path 0->1->3->5, which can handle 2 units of flow, then open switches along the path 0->2->4->5 to get another unit of flow in the network. Since 0->1, 2->4, and 3->5 are full, there is no direct way to get more flow from 0 to 5, but if we change the switch at 1 to redirect enough flow to fill 1->4, we open up enough capacity in 3->5 to allow us to add a unit of flow on 0->2->3->5. Even for this simple network, finding switch settings that increase the flow is not an easy task; for a complicated network, we are clearly interested in the following question: What switch settings will maximize the amount of oil flowing from source to sink? We can model this situation directly with an edge-weighted digraph that has a single source and a single sink. The edges in the network correspond to the oil pipes, the vertices correspond to the junctions with switches that control how much oil goes into each outgoing edge, and the weights on the edges correspond to the capacity of the pipes. We assume that the edges are directed, specifying that oil can flow in only one direction in each pipe. Each pipe has a certain amount of flow, which is less than or equal to its capacity, and every vertex satisfies the equilibrium condition that the flow in is equal to the flow out. This flow-network abstraction is a useful problem-solving model that applies directly to a variety of applications and indirectly to still more. We sometimes appeal to the idea of oil flowing through pipes for intuitive support of basic ideas,

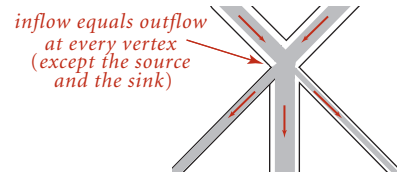

Local equilibrium in a flow network

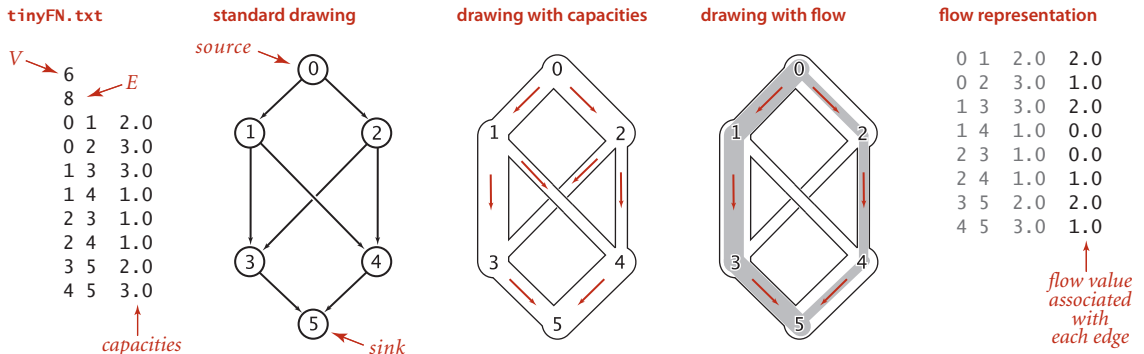

Anatomy of a network-flow problem

but our discussion applies equally well to goods moving through distribution channels and to numerous other situations. As with our use of distance in shortest-paths algorithms, we are free to abandon any physical intuition when convenient because all the definitions, properties, and algorithms that we consider are based entirely on an abstract model that does not necessarily obey physical laws. Indeed, a prime reason for our interest in the network-flow model is that it allows us to solve numerous other problems through reduction, as we see in the next section.

Definitions. Because of this broad applicability, it is worthwhile to consider precise statements of the terms and concepts that we have just informally introduced:

Definition. A *flow network* is an edge-weighted digraph with positive edge weights (which we refer to as *capacities*). An *st-flow network* has two identified vertices, a source s and a sink t .

We sometimes refer to edges as having infinite capacity or, equivalently, as being uncapacitated. That might mean that we do not compare flow against capacity for such edges, or we might use a sentinel value that is guaranteed to be larger than any flow value. We refer to the total flow into a vertex (the sum of the flows on its incoming edges) as the vertex's *inflow*, the total flow out of a vertex (the sum of the flows on its outgoing edges) as the vertex's *outflow*, and the difference between the two (inflow minus outflow) as the vertex's *netflow*. To simplify the discussion, we also assume that there are no edges leaving t or entering s .

Definition. An *st-flow* in an *st-flow network* is a set of nonnegative values associated with each edge, which we refer to as *edge flows*. We say that a flow is *feasible* if it satisfies the condition that no edge's flow is greater than that edge's capacity and the local equilibrium condition that the every vertex's netflow is zero (except s and t).

We refer to the sink's inflow as the *st-flow value*. We will see in PROPOSITION C that the value is also equal to the source's outflow. With these definitions, the formal statement of our basic problem is straightforward:

Maximum st-flow. Given an *st-flow network*, find an *st-flow* such that no other flow from s to t has a larger value.

For brevity, we refer to such a flow as a *maxflow* and the problem of finding one in a network as the *maxflow problem*. In some applications, we might be content to know

just the maxflow value, but we generally want to know a flow (edge flow values) that achieves that value.

APIs. The `FlowEdge` and `FlowNetwork` APIs shown on page 890 are straightforward extensions of APIs from CHAPTER 3. We will consider on page 896 an implementation of `FlowEdge` that is based on adding an instance variable containing the flow to our `WeightedEdge` class from page 610. Flows have a direction, but we do not base `FlowEdge` on `WeightedDirectedEdge` because we work with a more general abstraction known as the *residual network* that is described below, and we need each edge to appear in the adjacency lists of both its vertices to implement the residual network. The residual network allows us to both add and subtract flow and to test whether an edge is full to capacity (no more flow can be added) or empty (no flow can be subtracted). This abstraction is implemented via the methods `residualCapacity()` and `addResidualFlow()` that we will consider later. The implementation of `FlowNetwork` is virtually identical to our `EdgeWeightedGraph` implementation on page 611, so we omit it. To simplify the file format, we adopt the convention that the source is 0 and the sink is $V-1$. These APIs leave a straightforward goal for maxflow algorithms: build a network, then assign values to the flow instance variables in the client's edges that maximize flow through the network. Shown at right are client methods for certifying whether a flow is feasible. Typically, we might do such a check as the final action of a maxflow algorithm.

```
private boolean localEq(FlowNetwork G, int v)
{ // Check local equilibrium at each vertex.
  double EPSILON = 1E-11;
  double netflow = 0.0;
  for (FlowEdge e : G.adj(v))
    if (v == e.from()) netflow -= e.flow();
    else                 netflow += e.flow();

  return Math.abs(netflow) < EPSILON;
}

private boolean isFeasible(FlowNetwork G)
{
  // Check that flow on each edge is nonnegative
  // and not greater than capacity.
  for (int v = 0; v < G.V(); v++)
    for (FlowEdge e : G.adj(v))
      if (e.flow() < 0 || e.flow() > e.cap())
        return false;

  // Check local equilibrium at each vertex.
  for (int v = 0; v < G.V(); v++)
    if (v != s && v != t && !localEq(v))
      return false;

  return true;
}
```

Checking that a flow is feasible in a flow network

```
public class FlowEdge
```

```

    FlowEdge(int v, int w, double cap)
    int from()
    int to()
    int other(int v)
    double capacity()
    double flow()
    double residualCapacityTo(int v)
    double addFlowTo(int v, double delta)
    String toString()

```

vertex this edge points from
vertex this edge points to
other endpoint
capacity of this edge
flow in this edge
residual capacity toward v
add delta flow toward v
string representation

API for edges in a flow network

```
public class FlowNetwork
```

```

    FlowNetwork(int V)
    FlowNetwork(In in)
    int V()
    int E()
    void addEdge(FlowEdge e)
    Iterable<FlowEdge> adj(int v)
    Iterable<FlowEdge> edges()
    String toString()

```

empty V-vertex flow network
construct from input stream
number of vertices
number of edges
add e to this flow network
edges pointing from v
all edges in this flow network
string representation

Flow network API

tinyFN.txt

```

V → 6
8 ← E
0 1 2.0
0 2 3.0
1 3 3.0
1 4 1.0
2 3 1.0
2 4 1.0
3 5 2.0
4 5 3.0

```

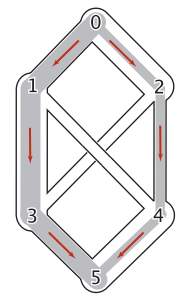
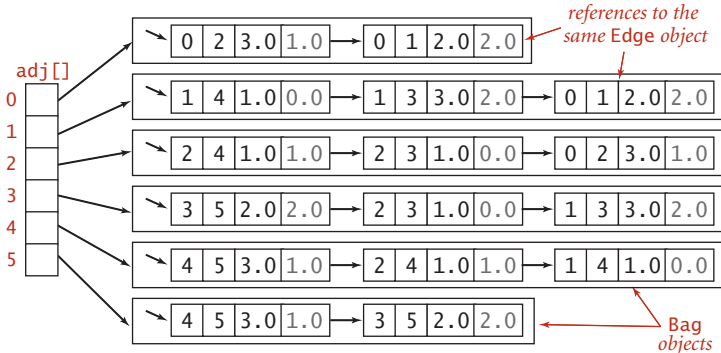

Flow network representation

Ford-Fulkerson algorithm. An effective approach to solving max-flow problems was developed by L. R. Ford and D. R. Fulkerson in 1962. It is a generic method for increasing flows incrementally along paths from source to sink that serves as the basis for a family of algorithms. It is known as the *Ford-Fulkerson algorithm* in the classical literature; the more descriptive term *augmenting-path algorithm* is also widely used. Consider any directed path from source to sink through an *st*-flow network. Let x be the minimum of the unused capacities of the edges on the path. We can increase the network's flow value by at least x by increasing the flow in all edges on the path by that amount. Iterating this action, we get a first attempt at computing flow in a network: find another path, increase the flow along that path, and continue until all paths from source to sink have at least one full edge (so that we can no longer increase flow in this way). This algorithm will compute the maxflow in some cases but will fall short in other cases. Our introductory example on page 886 is such an example. To improve the algorithm such that it always finds a maxflow, we consider a more general way to increase the flow, along a path from source to sink through the network's underlying *undirected* graph. The edges on any such path are either *forward* edges, which go with the flow (when we traverse the path from source to sink, we traverse the edge from its source vertex to its destination vertex), or *backward* edges, which go against the flow (when we traverse the path from source to sink, we traverse the edge from its destination vertex to its source vertex). Now, for any path with no full forward edges and no empty backward edges, we can increase the amount of flow in the network by increasing flow in forward edges and decreasing flow in backward edges. The amount by which the flow can be increased is limited by the minimum of the unused capacities in the forward edges and the flows in the backward edges. Such a path is called an *augmenting path*. An example is shown at right. In the new flow, at least one of the forward edges along the path becomes full or at least one of the backward edges along the path becomes empty. The process just sketched is the basis for the classical Ford-Fulkerson maxflow algorithm (augmenting-path method). We summarize it as follows:

no path from 0 to 5
without a full edge

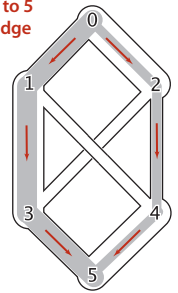

add 1 unit of flow
along $0 \rightarrow 2 \rightarrow 3$

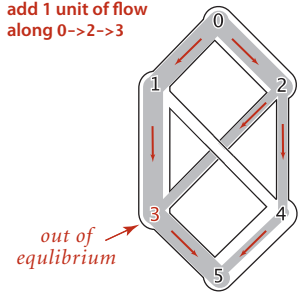

out of
equilibrium

subtract 1 unit of flow
from $1 \rightarrow 3$
(traverse $3 \rightarrow 1$)

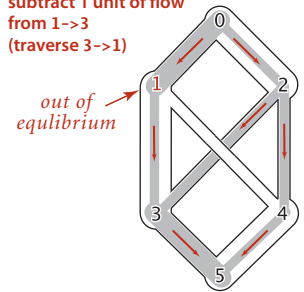

out of
equilibrium

add 1 unit of flow
along $1 \rightarrow 4 \rightarrow 5$

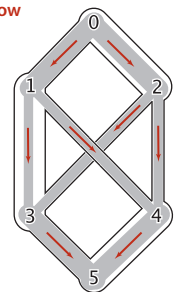

An augmenting path
($0 \rightarrow 2 \rightarrow 3 \rightarrow 1 \rightarrow 4 \rightarrow 5$)

Ford-Fulkerson maxflow algorithm. Start with zero flow everywhere. Increase the flow along any augmenting path from source to sink (with no full forward edges or empty backward edges), continuing until there are no such paths in the network.

Remarkably (under certain technical conditions about numeric properties of the flow), this method always finds a maxflow, no matter how we choose the paths. Like the greedy MST algorithm discussed in SECTION 4.3 and the generic shortest-paths method discussed in SECTION 4.4, it is a generic algorithm that is useful because it establishes the correctness of a whole family of more specific algorithms. We are free to use any method whatever to choose the path. Several algorithms that compute sequences of augmenting paths have been developed, all of which lead to a maxflow. The algorithms differ in the number of augmenting paths they compute and the costs of finding each path, but they all implement the Ford-Fulkerson algorithm and find a maxflow.

Maxflow-mincut theorem. To show that any flow computed by any implementation of the Ford-Fulkerson algorithm is indeed a maxflow, we prove a key fact known as the *maxflow-mincut theorem*. Understanding this theorem is a crucial step in understanding network-flow algorithms. As suggested by its name, the theorem is based on a direct relationship between flows and cuts in networks, so we begin by defining terms that relate to cuts. Recall from SECTION 4.3 that a *cut* in a graph is a partition of the vertices into two disjoint sets, and a crossing edge is an edge that connects a vertex in one set to a vertex in the other set. For flow networks, we refine these definitions as follows:

Definition. An *st-cut* is a cut that places vertex s in one of its sets and vertex t in the other.

Each crossing edge corresponding to an *st-cut* is either an *st-edge* that goes from a vertex in the set containing s to a vertex in the set containing t , or a *ts-edge* that goes in the other direction. We sometimes refer to the set of crossing *st-edges* as a *cut set*. The *capacity* of an *st-cut* in a flow network is the sum of the capacities of that cut's *st-edges*, and the *flow across* an *st-cut* is the difference between the sum of the flows in that cut's *st-edges* and the sum of the flows in that cut's *ts-edges*. Removing all the *st-edges* (the cut set) in an *st-cut* of a network leaves no path from s to t , but adding any one of them back could create such a path. Cuts are the appropriate abstraction for many applications. For our oil-flow model, a cut provides a way to completely stop the flow of oil

from the source to the sink. If we view the capacity of the cut as the cost of doing so, to stop the flow in the most economical manner is to solve the following problem:

Minimum st -cut. Given an st -network, find an st -cut such that the capacity of no other cut is smaller. For brevity, we refer to such a cut as a *mincut* and to the problem of finding one in a network as the *mincut problem*.

The statement of the mincut problem includes no mention of flows, and these definitions might seem to digress from our discussion of the augmenting-path algorithm. On the surface, computing a mincut (a set of edges) seems easier than computing a maxflow (an assignment of weights to all the edges). On the contrary, the maxflow and mincut problems are intimately related. The augmenting-path method itself provides a proof. That proof rests on the following basic relationship between flows and cuts, which immediately gives a proof that local equilibrium in an st -flow implies global equilibrium as well (the first corollary) and an upper bound on the value of any st -flow (the second corollary):

Proposition E. For any st -flow, the flow across each st -cut is equal to the value of the flow.

Proof: Let C_s be the vertex set containing s and C_t the vertex set containing t . This fact follows immediately by induction on the size of C_t . The property is true by definition when C_t is t and when a vertex is moved from C_s to C_t , local equilibrium at that vertex implies that the stated property is preserved. Any st -cut can be created by moving vertices in this way.

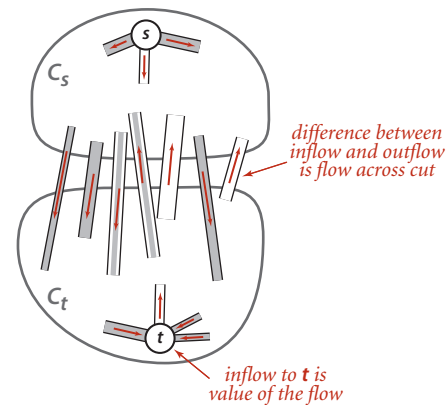

Corollary. The outflow from s is equal to the inflow to t (the value of the st -flow).

Proof: Let C_s be $\{s\}$.

Corollary. No st -flow's value can exceed the capacity of any st -cut.

Proposition F. (Maxflow-mincut theorem) Let f be an st -flow. The following three conditions are equivalent:

- i.* There exists an st -cut whose capacity equals the value of the flow f .
- ii.* f is a maxflow.
- iii.* There is no augmenting path with respect to f .

Proof: Condition *i.* implies condition *ii.* by the corollary to PROPOSITION E. Condition *ii.* implies condition *iii.* because the existence of an augmenting path implies the existence of a flow with a larger flow value, contradicting the maximality of f .

It remains to prove that condition *iii.* implies condition *i.* Let C_s be the set of all vertices that can be reached from s with an undirected path that does not contain a full forward or empty backward edge, and let C_t be the remaining vertices. Then, t must be in C_t , so (C_s, C_t) is an st -cut, whose cut set consists entirely of full forward or empty backward edges. The flow across this cut is equal to the cut's capacity (since forward edges are full and the backward edges are empty) and also to the value of the network flow (by PROPOSITION E).

Corollary. (Integrality property) When capacities are integers, there exists an integer-valued maxflow, and the Ford-Fulkerson algorithm finds it.

Proof: Each augmenting path increases the flow by a positive integer (the minimum of the unused capacities in the forward edges and the flows in the backward edges, all of which are always positive integers).

It is possible to design a maxflow with noninteger flows, even when capacities are all integers, but we do not need to consider such flows. From a theoretical standpoint, this observation is important: allowing capacities and flows that are real numbers, as we have done and as is common in practice, can lead to unpleasant anomalous situations. For example, it is known that the Ford-Fulkerson algorithm could, in principle, lead to an infinite sequence of augmenting paths that does not even converge to the maxflow value. The version of the algorithm that we consider is known to always converge, even when capacities and flows are real-valued. No matter what method we choose to find an augmenting path and no matter what paths we find, we always end up with a flow that does not admit an augmenting path, which therefore must be a maxflow.

Residual network. The generic Ford-Fulkerson algorithm does not specify any particular method for finding an augmenting path. How can we find a path with no full forward edges and no empty backward edges? To this end, we begin with the following definition:

Definition. Given a st -flow network and an st -flow, the *residual network* for the flow has the same vertices as the original and one or two edges in the residual network for each edge in the original, defined as follows: For each edge e from v to w in the original, let f_e be its flow and c_e its capacity. If f_e is positive, include an edge $w \rightarrow v$ in the residual with capacity f_e ; and if f_e is less than c_e , include an edge $v \rightarrow w$ in the residual with capacity $c_e - f_e$.

If an edge e from v to w is empty (f_e is equal to 0), there is a single corresponding edge $v \rightarrow w$ with capacity c_e in the residual; if it is full (f_e is equal to c_e), there is a single corresponding edge $w \rightarrow v$ with capacity f_e in the residual; and if it is neither empty nor full, both $v \rightarrow w$ and $w \rightarrow v$ are in the residual with their respective capacities. An example is shown at the bottom of this page. At first, the residual network representation is a bit confusing because the edges corresponding to flow go in the *opposite* direction of the flow itself. The forward edges represent the remaining capacity (the amount of flow we can add if traversing that edge); the backward edges represent the flow (the amount of flow we can remove if traversing that edge). The code on page 896 gives the methods in the `FlowEdge` class that we need to implement the residual network abstraction. With these implementations, our algorithms work with the residual network, but they are actually examining capacities and changing flow (through edge references) in the client's edges. The methods `from()` and `other()` allow us to process edges in either orientation:

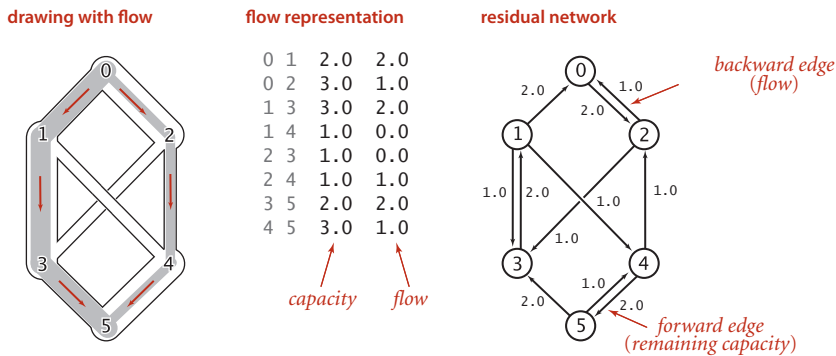

Anatomy of a network-flow problem (revisited)

Flow edge data type (residual network)

```

public class FlowEdge
{
    private final int v;           // edge source
    private final int w;           // edge target
    private final double capacity; // capacity
    private double flow;           // flow

    public FlowEdge(int v, int w, double capacity)
    {
        this.v = v;
        this.w = w;
        this.capacity = capacity;
        this.flow = 0.0;
    }

    public int from()      { return v;      }
    public int to()        { return w;      }
    public double capacity() { return capacity; }
    public double flow()   { return flow;   }

    public int other(int vertex)
    // same as for Edge

    public double residualCapacityTo(int vertex)
    {
        if (vertex == v) return flow;
        else if (vertex == w) return cap - flow;
        else throw new RuntimeException("Inconsistent edge");
    }

    public void addResidualFlowTo(int vertex, double delta)
    {
        if (vertex == v) flow -= delta;
        else if (vertex == w) flow += delta;
        else throw new RuntimeException("Inconsistent edge");
    }

    public String toString()
    { return String.format("%d->%d %.2f %.2f", v, w, capacity, flow); }
}

```

This `FlowEdge` implementation adds to the weighted `DirectedEdge` implementation of SECTION 4.4 (see page 642) a `flow` instance variable and two methods to implement the residual flow network.

`e.other(v)` returns the endpoint of `e` that is not `v`. The methods `residualCapTo()` and `addResidualFlowTo()` implement the residual network. Residual networks allow us to use graph search to find an augmenting path, since any path from source to sink in the residual network corresponds directly to an augmenting path in the original network. Increasing the flow along the path implies making changes in the residual network: for example, at least one edge on the path becomes full or empty, so at least one edge in the residual network changes direction or disappears (but our use of an abstract residual network means that we just check for positive capacity and do not need to actually insert and delete edges).

Shortest-augmenting-path method. Perhaps the simplest Ford-Fulkerson implementation is to use a *shortest* augmenting path (as measured by the number of edges on the path, not flow or capacity). This method was suggested by J. Edmonds and R. Karp in 1972. In this case, the search for an augmenting path amounts to breadth-first search (BFS) in the residual network, precisely as described in SECTION 4.1, as you can see by comparing the `hasAugmentingPath()` implementation below to our breadth-first search implementation in ALGORITHM 4.2 on page 540 (the residual graph is a digraph, and this is fundamentally a digraph processing algorithm, as mentioned on page 685). This method forms the basis for the full implementation in ALGORITHM 6.14 on the next page, a remarkably concise implementation based on the tools we have developed. For brevity, we refer to this method as the *shortest-augmenting-path* maxflow algorithm. A trace for our example is shown in detail on page 899.

```
private boolean hasAugmentingPath(FlowNetwork G, int s, int t)
{
    marked = new boolean[G.V()]; // Is path to this vertex known?
    edgeTo = new FlowEdge[G.V()]; // last edge on path
    Queue<Integer> q = new Queue<Integer>();

    marked[s] = true; // Mark the source
    q.enqueue(s); // and put it on the queue.
    while (!q.isEmpty())
    {
        int v = q.dequeue();
        for (FlowEdge e : G.adj(v))
        {
            int w = e.other(v);
            if (e.residualCapacityTo(w) > 0 && !marked[w])
            { // For every edge to an unmarked vertex (in residual)
                edgeTo[w] = e; // Save the last edge on a path.
                marked[w] = true; // Mark w because a path is known
                q.enqueue(w); // and add it to the queue.
            }
        }
    }
    return marked[t];
}
```

Finding an augmenting path in the residual network via breadth-first search

ALGORITHM 6.14 Ford-Fulkerson shortest-augmenting path maxflow algorithm

```

public class FordFulkerson
{
    private boolean[] marked;    // Is s->v path in residual graph?
    private FlowEdge[] edgeTo;  // last edge on shortest s->v path
    private double value;       // current value of maxflow

    public FordFulkerson(FlowNetwork G, int s, int t)
    { // Find maxflow in flow network G from s to t.

        while (hasAugmentingPath(G, s, t))
        { // While there exists an augmenting path, use it.

            // Compute bottleneck capacity.
            double bottle = Double.POSITIVE_INFINITY;
            for (int v = t; v != s; v = edgeTo[v].other(v))
                bottle = Math.min(bottle, edgeTo[v].residualCapacityTo(v));

            // Augment flow.
            for (int v = t; v != s; v = edgeTo[v].other(v))
                edgeTo[v].addResidualFlowTo(v, bottle);

            value += bottle;
        }
    }

    public double value()        { return value;        }
    public boolean inCut(int v)  { return marked[v];    }

    public static void main(String[] args)
    {
        FlowNetwork G = new FlowNetwork(new In(args[0]));
        int s = 0, t = G.V() - 1;
        FordFulkerson maxflow = new FordFulkerson(G, s, t);

        StdOut.println("Max flow from " + s + " to " + t);
        for (int v = 0; v < G.V(); v++)
            for (FlowEdge e : G.adj(v))
                if ((v == e.from()) && e.flow() > 0)
                    StdOut.println("    " + e);
        StdOut.println("Max flow value = " + maxflow.value());
    }
}

```

This implementation of the Ford-Fulkerson algorithm finds the shortest augmenting path in the residual network, finds the bottleneck capacity in that path, and augments the flow along that path, continuing until no path from source to sink exists.

initial empty network

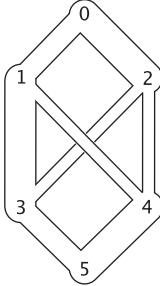

residual network

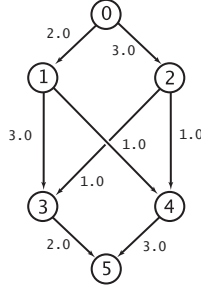

add 2 units of flow along 0->1->3->5

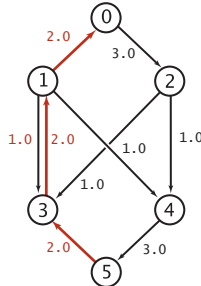
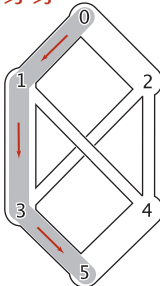

add 1 unit of flow along 0->2->4->5

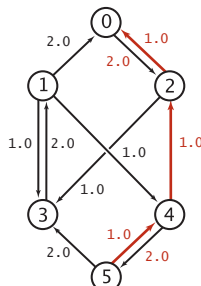
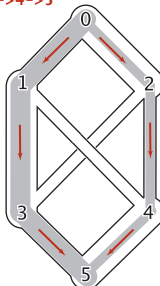

add 1 unit of flow along 0->2->3->1->4->5

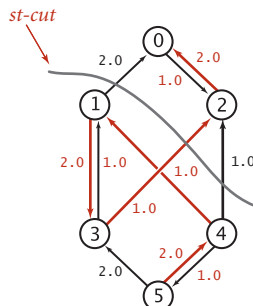
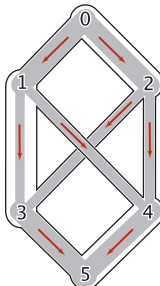

```
% java FordFulkerson tinyFN.txt
Max flow from 0 to 5
0->2 3.0 2.0
0->1 2.0 2.0
1->4 1.0 1.0
1->3 3.0 1.0
2->3 1.0 1.0
2->4 1.0 1.0
3->5 2.0 2.0
4->5 3.0 2.0
Max flow value = 4.0
```

Trace of augmenting-path Ford-Fulkerson algorithm

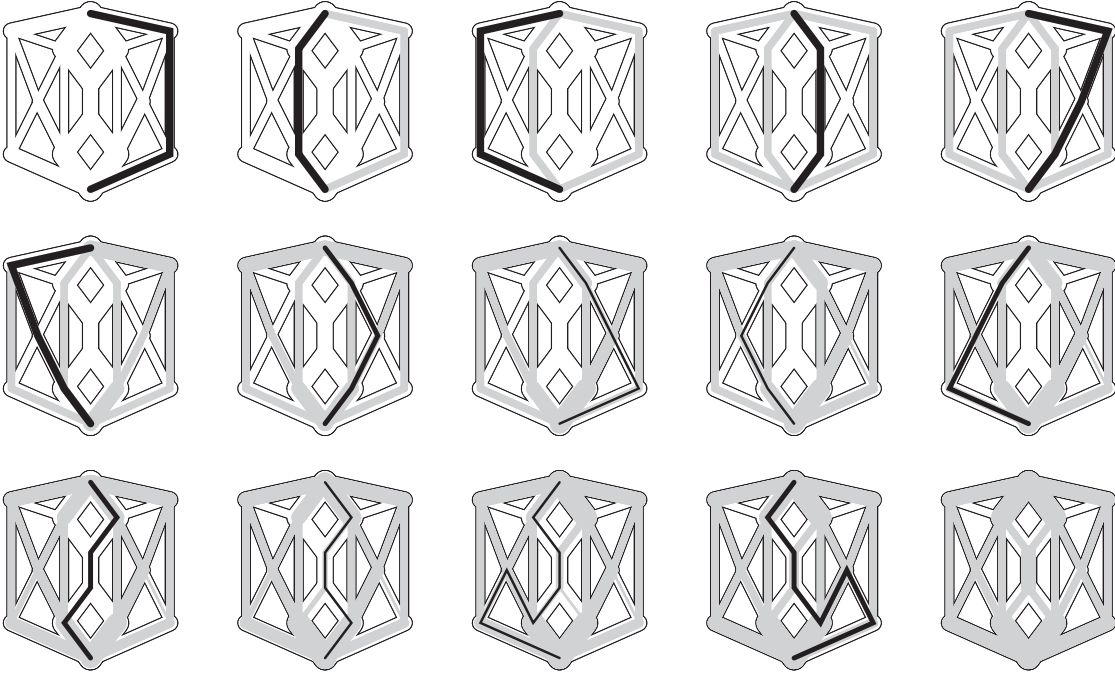

Shortest augmenting paths in a larger flow network

Performance. A larger example is shown in the figure above. As is evident from the figure, the lengths of the augmenting paths form a nondecreasing sequence. This fact is a first key to analyzing the performance of the algorithm.

Proposition G. The number of augmenting paths needed in the shortest-augmenting-path implementation of the Ford-Fulkerson maxflow algorithm for a flow network with V vertices and E edges is at most $EV/2$.

Proof sketch: Every augmenting path has a *critical edge*—an edge that is deleted from the residual network because it corresponds either to a forward edge that becomes filled to capacity or a backward edge that is emptied. Each time an edge is a critical edge, the length of the augmenting path through it must increase by 2 (see EXERCISE 6.39). Since an augmenting path is of length at most V each edge can be on at most $V/2$ augmenting paths, and the total number of augmenting paths is at most $EV/2$.

Corollary. The shortest-augmenting-path implementation of the Ford-Fulkerson maxflow algorithm takes time proportional to $VE^2/2$ in the worst case.

Proof: Breadth-first search examines at most E edges.

The upper bound of PROPOSITION 6 is very conservative. For example, the graph shown in the figure at the top of page 900 has 11 vertices and 20 edges, so the bound says that the algorithm uses no more than 110 augmenting paths. In fact, it uses 14.

Other implementations. Another Ford-Fulkerson implementation, suggested by Edmonds and Karp, is the following: Augment along the path that increases the flow by the largest amount. For brevity, we refer to this method as the *maximum-capacity-augmenting-path* maxflow algorithm. We can implement this (and other approaches) by using a priority queue and slightly modifying our implementation of Dijkstra's shortest-paths algorithm, choosing edges from the priority queue to give the maximum amount of flow that can be pushed through a forward edge or diverted from a backward edge. Or, we might look for a longest augmenting path, or make a random choice. A complete analysis establishing which method is best is a complex task, because their running times depend on

- The number of augmenting paths needed to find a maxflow
- The time needed to find each augmenting path

These quantities can vary widely, depending on the network being processed and on the graph-search strategy. Several other approaches to solving the maxflow problem have also been devised, some of which compete well with the Ford-Fulkerson algorithm in practice. Developing a mathematical model of maxflow algorithms that can validate such hypotheses, however, is a significant challenge. The analysis of maxflow algorithms remains an interesting and active area of research. From a theoretical standpoint, worst-case performance bounds for numerous maxflow algorithms have been developed, but the bounds are generally substantially higher than the actual costs observed in applications and also quite a bit higher than the trivial (linear-time) lower bound. This gap between what is known and what is possible is larger than for any other problem that we have considered (so far) in this book.

THE PRACTICAL APPLICATION of maxflow algorithms remains both an art and a science. The art lies in picking the strategy that is most effective for a given practical situation; the science lies in understanding the essential nature of the problem. Are there new data structures and algorithms that can solve the maxflow problem in linear time, or can we prove that none exist?

algorithm	worst-case order of growth of running time for V vertices and E edges with integral capacities (max C)
<i>Ford-Fulkerson shortest augmenting path</i>	VE^2
<i>Ford-Fulkerson maximal augmenting path</i>	$E^2 \log C$
<i>preflow-push</i>	$EV \log(E/V^2)$
<i>possible?</i>	$V + E?$

Performance characteristics of maxflow algorithms

Reduction Throughout this book, we have focused on articulating specific problems, then developing algorithms and data structures to solve them. In several cases (many of which are listed below), we have found it convenient to solve a problem by formulating it as an instance of another problem that we have already solved. Formalizing this notion is a worthwhile starting point for studying relationships among the diverse problems and algorithms that we have studied.

Definition. We say that a problem A *reduces to* another problem B if we can use an algorithm that solves B to develop an algorithm that solves A .

This concept is certainly a familiar one in software development: when you use a library method to solve a problem, you are reducing your problem to the one solved by the library method. In this book, we have informally referred to problems that we can reduce to a given problem as *applications*.

Sorting reductions. We first encountered reduction in CHAPTER 2, to express the idea that an efficient sorting algorithm is useful for efficiently solving many other problems, that may not seem to be at all related to sorting. For example, we considered the following problems, among many others:

Finding the median. Given a set of numbers, find the median value.

Distinct values. Determine the number of distinct values in a set of numbers.

Scheduling to minimize average completion time. Given a set of jobs of specified duration to be completed, how can we schedule the jobs on a single processor so as to minimize their average completion time?

Proposition H. The following problems reduce to sorting:

- Finding the median
- Counting distinct values
- Scheduling to minimize average completion time

Proof: See page 345 and EXERCISE 2.5.12.

Now, we have to pay attention to cost when doing a reduction. For example, we can find the median of a set of numbers in linear time, but using the reduction to sorting will

end up costing linearithmic time. Even so, such extra cost might be acceptable, since we can use an existing sort implementation. Sorting is valuable for three reasons:

- It is useful in its own right.
- We have an efficient algorithms for solving it.
- Many problems reduce to it.

Generally, we refer to a problem with these properties as a *problem-solving model*. Like well-engineered software libraries, well-designed problem-solving models can greatly expand the universe of problems that we can efficiently address. One pitfall in focusing on problem-solving models is known as *Maslow's hammer*, an idea widely attributed to A. Maslow in the 1960s: *If all you have is a hammer, everything seems to be a nail*. By focusing on a few problem-solving models, we may use them like Maslow's hammer to solve every problem that comes along, depriving ourselves of the opportunity to discover better algorithms to solve the problem, or even new problem-solving models. While the models we consider are important, powerful, and broadly useful, it is also wise to consider other possibilities.

Shortest-paths reductions. In SECTION 4.4, we revisited the idea of reduction in the context of shortest-paths algorithms. We considered the following problems, among many others:

Single-source shortest paths in undirected graphs. Given an edge-weighted *undirected* graph with nonnegative weights and a source vertex s , support queries of the form *Is there a path from s to a given target vertex v ?* If so, find a *shortest* such path (one whose total weight is minimal).

Parallel precedence-constrained scheduling. Given a set of jobs of specified duration to be completed, with precedence constraints that specify that certain jobs have to be completed before certain other jobs are begun, how can we schedule the jobs on identical processors (as many as needed) such that they are all completed in the minimum amount of time while still respecting the constraints?

Arbitrage. Find an arbitrage opportunity in a given table of currency-conversion rates.

Again, the latter two problems do not seem to be directly related to shortest-paths problems, but we saw that shortest paths is an effective way to address them. These examples, while important, are merely indicative. A large number of important problems, too many to survey here, are known to reduce to shortest paths—it is an effective and important problem-solving model.

Proposition I. The following problems reduce to shortest paths in weighted digraphs:

- Single-source shortest paths in undirected graphs with nonnegative weights
- Parallel precedence-constrained scheduling
- Arbitrage
- [many other problems]

Proof examples: See page 654, page 665, and page 680.

Maxflow reductions. Maxflow algorithms are also important in a broad context. We can remove various restrictions on the flow network and solve related flow problems; we can solve other network- and graph-processing problems; and we can solve problems that are not network problems at all. For example, consider the following problems.

Job placement. A college's job-placement office arranges interviews for a set of students with a set of companies; these interviews result in a set of job offers. Assuming that an interview followed by a job offer represents mutual interest in the student taking a job at the company, it is in everyone's best interests to maximize the number of job placements. Is it possible to match every student with a job? What is the maximum number of jobs that can be filled?

Product distribution. A company that manufactures a single product has factories, where the product is produced; distribution centers, where the product is stored temporarily; and retail outlets, where the product is sold. The company must distribute the product from factories through distribution centers to retail outlets on a regular basis, using distribution channels that have varying capacities. Is it possible to get the product from the warehouses to the retail outlets such that supply meets demand everywhere?

Network reliability. A simplified model considers a computer network as consisting of a set of trunk lines that connect computers through switches such that there is the possibility of a switched path through trunk lines connecting any two given computers. What is the minimum number of trunk lines that can be cut to disconnect some pair of computers?

Again, these problems seem to be unrelated to one another and to flow networks, but they all reduce to maxflow.

Proposition J. The following problems reduce to the maxflow problem:

- Job placement
- Product distribution
- Network reliability
- [many other problems]

Proof example: We prove the first (which is known as the *maximum bipartite matching problem*) and leave the others for exercises. Given a job-placement problem, construct an instance of the maxflow problem by directing all edges from students to companies, adding a source vertex with edges directed to all the students and adding a sink vertex with edges directed from all the companies. Assign each edge capacity 1. Now, any integral solution to the maxflow problem for this network provides a solution to the corresponding bipartite matching problem (see the corollary to PROPOSITION F). The matching corresponds exactly to those edges between vertices in the two sets that are filled to capacity by the maxflow algorithm. First, the network flow always gives a legal matching: since each vertex has an edge of capacity 1 either coming in (from the sink) or going out (to the source), at most 1 unit of flow can go through each vertex, implying in turn that each vertex will be included at most once in the matching. Second, no matching can have more edges, since any such matching would lead directly to a better flow than that produced by the maxflow algorithm.

bipartite matching problem

- | | |
|----------|------------|
| 1 Alice | 7 Adobe |
| Adobe | Alice |
| Amazon | Bob |
| Facebook | Dave |
| 2 Bob | 8 Amazon |
| Adobe | Alice |
| Amazon | Bob |
| Yahoo | Dave |
| 3 Carol | 9 Facebook |
| Facebook | Alice |
| Google | Carol |
| IBM | 10 Google |
| 4 Dave | 10 Google |
| Adobe | Carol |
| Amazon | Eliza |
| 5 Eliza | 11 IBM |
| Google | Carol |
| IBM | Eliza |
| Yahoo | Frank |
| 6 Frank | 12 Yahoo |
| IBM | Bob |
| Yahoo | Eliza |
| | Frank |

network-flow formulation

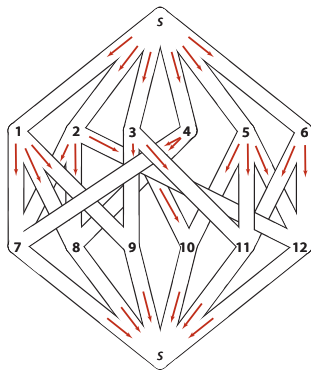

maximum flow

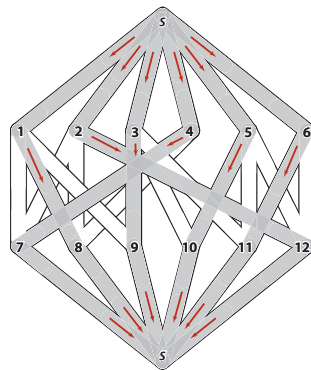

matching (solution)

- Alice — Amazon
- Bob — Yahoo
- Carol — Facebook
- Dave — Adobe
- Eliza — Google
- Frank — IBM

Example of reducing maximum bipartite matching to network flow

For example, as illustrated in the figure at right, an augmenting-path max-flow algorithm might use the paths $s \rightarrow 1 \rightarrow 7 \rightarrow t$, $s \rightarrow 2 \rightarrow 8 \rightarrow t$, $s \rightarrow 3 \rightarrow 9 \rightarrow t$, $s \rightarrow 5 \rightarrow 10 \rightarrow t$, $s \rightarrow 6 \rightarrow 11 \rightarrow t$, and $s \rightarrow 4 \rightarrow 7 \rightarrow 1 \rightarrow 8 \rightarrow 2 \rightarrow 12 \rightarrow t$ to compute the matching 1-8, 2-12, 3-9, 4-7, 5-10, and 6-11. Thus, there is a way to match all the students to jobs in our example. Each augmenting path fills one edge from the source and one edge into the sink. Note that these edges are never used as back edges, so there are at most V augmenting paths, and a total running time proportional to VE .

SHORTEST PATHS AND MAXFLOW ARE IMPORTANT problem-solving models because they have the same properties that we articulated for sorting:

- They are useful in their own right.
- We have efficient algorithms for solving them.
- Many problems reduce to them.

This short discussion serves only to introduce the idea. If you take a course in operations research, you will learn many other problems that reduce to these and many other problem-solving models.

Linear programming. One of the cornerstones of operations research is *linear programming* (LP). It refers to the idea of reducing a given problem to the following mathematical formulation:

Linear programming. Given a set of M *linear inequalities* and linear equations involving N variables, and a linear *objective function* of the N variables, find an assignment of values to the variables that maximizes the objective function, or report that no feasible assignment exists.

Maximize $f + h$
subject to the constraints

- $0 \leq a \leq 2$
- $0 \leq b \leq 3$
- $0 \leq c \leq 3$
- $0 \leq d \leq 1$
- $0 \leq e \leq 1$
- $0 \leq f \leq 1$
- $0 \leq g \leq 2$
- $0 \leq h \leq 3$
- $a = c + d$
- $b = e + f$
- $c + e = g$
- $d + f = h$

LP example

Linear programming is an extremely important problem-solving model because

- A great many important problems reduce to linear programming
- We have efficient algorithms for solving linear-programming problems

The “useful in its own right” phrase is not needed in this litany that we have stated for other problem-solving models because *so many* practical problems reduce to linear programming.

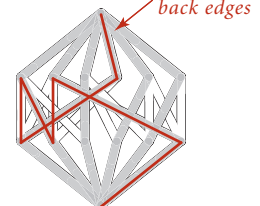
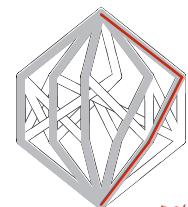
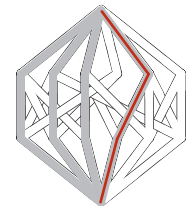
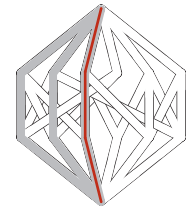
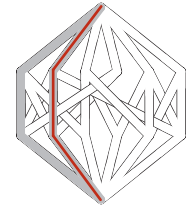
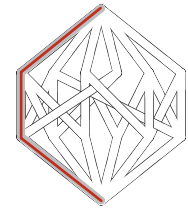

Augmenting paths for bipartite matching

Proposition K. The following problems reduce to linear programming

- Maxflow
- Shortest paths
- [many, many other problems]

Proof example: We prove the first and leave the second to EXERCISE 6.49. We consider a system of inequalities and equations that involve one variable corresponding to each edge, two inequalities corresponding to each edge, and one equation corresponding to each vertex (except the source and the sink). The value of the variable is the edge flow, the inequalities specify that the edge flow must be between 0 and the edge's capacity, and the equations specify that the total flow on the edges that go into each vertex must be equal to the total flow on the edges that go out of that vertex. Any max flow problem can be converted into an instance of a linear programming problem in this way, and the solution is easily converted to a solution of the maxflow problem. The illustration below gives the details for our example.

maxflow problem

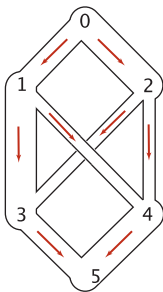
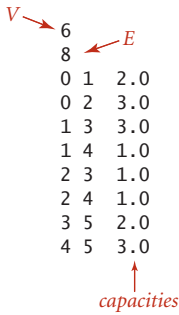

LP formulation

Maximize $x_{35} + x_{45}$
subject to the constraints

- $0 \leq x_{01} \leq 2$
- $0 \leq x_{02} \leq 3$
- $0 \leq x_{13} \leq 3$
- $0 \leq x_{14} \leq 1$
- $0 \leq x_{23} \leq 1$
- $0 \leq x_{24} \leq 1$
- $0 \leq x_{35} \leq 2$
- $0 \leq x_{45} \leq 3$

- $x_{01} = x_{13} + x_{14}$
- $x_{02} = x_{23} + x_{24}$
- $x_{13} + x_{23} = x_{35}$
- $x_{14} + x_{24} = x_{45}$

LP solution

- $x_{01} = 2$
- $x_{02} = 2$
- $x_{13} = 1$
- $x_{14} = 1$
- $x_{23} = 1$
- $x_{24} = 1$
- $x_{35} = 2$
- $x_{45} = 2$

maxflow solution

Max flow from 0 to 5

- 0->2 3.0 2.0
- 0->1 2.0 2.0
- 1->4 1.0 1.0
- 1->3 3.0 1.0
- 2->3 1.0 1.0
- 2->4 1.0 1.0
- 3->5 2.0 2.0
- 4->5 3.0 2.0

Max flow value: 4.0

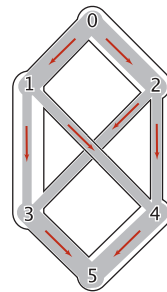

Example of reducing network flow to linear programming

The “many, many other problems” in the statement of PROPOSITION K refers to three ideas. First, *it is very easy to extend a model and to add constraints*. Second, *reduction is transitive*, so all the problems that reduce to shortest paths and maximum flow also reduce to linear programming. Third, and more generally, *optimization problems of all sorts can be directly formulated as linear programming problems*. Indeed, the term *linear programming* means “formulate an optimization problem as a linear programming problem.” This use predates the use of the word *programming* for computers. Equally important as the idea that a great many problems reduce to linear programming is the fact that efficient algorithms have been known for linear programming for many decades. The most famous, developed by G. Dantzig in the 1940s, is known as the *simplex algorithm*. Simplex is not difficult to understand (see the bare-bones implementation on the booksite). More recently, the *ellipsoid algorithm* presented by L. G. Khachian in 1979 led to the development of *interior point methods* in the 1980s that have proven to be an effective complement to the simplex algorithm for the huge linear programming problems that people are solving in modern applications. Nowadays, linear programming solvers are robust, extensively tested, efficient, and critical to the basic operation of modern corporations. Uses in scientific contexts and even in applications programming are also greatly expanding. If you can model your problem as a linear programming problem, you are likely to be able to solve it.

IN A VERY REAL SENSE, LINEAR PROGRAMMING IS THE PARENT of problem-solving models, since so many problems reduce to it. Naturally, this idea leads to the question of whether there is an even more powerful problem-solving model than linear programming. What sorts of problems do *not* reduce to linear programming? Here is an example of such a problem:

Load balancing. Given a set of jobs of specified duration to be completed, how can we schedule the jobs on two identical processors so as to minimize the completion time of all the jobs?

Can we articulate a more general problem-solving model and solve instances of problems within that model efficiently? This line of thinking leads to the idea of *intractability*, our last topic.

Intractability The algorithms that we have studied in this book generally are used to solve practical problems and therefore consume reasonable amounts of resources. The practical utility of most of the algorithms is obvious, and for many problems we have the luxury of several efficient algorithms to choose from. Unfortunately, many other problems arise in practice that do not admit such efficient solutions. What's worse, for a large class of such problems we cannot even tell whether or not an efficient solution exists. This state of affairs has been a source of extreme frustration for programmers and algorithm designers, who cannot find any efficient algorithm for a wide range of practical problems, and for theoreticians, who have been unable to find any proof that these problems are difficult. A great deal of research has been done in this area and has led to the development of mechanisms by which new problems can be classified as being "hard to solve" in a particular technical sense. Though much of this work is beyond the scope of this book, the central ideas are not difficult to learn. We introduce them here because every programmer, when faced with a new problem, should have some understanding of the possibility that there exist problems for which no one knows any algorithm that is guaranteed to be efficient.

Groundwork. One of the most beautiful and intriguing intellectual discoveries of the 20th century, developed by A. Turing in the 1930s, is the *Turing machine*, a simple model of computation that is general enough to embody any computer program or computing device. A Turing machine is a finite-state machine that can read inputs, move from state to state, and write outputs. Turing machines form the foundation of theoretical computer science, starting with the following two ideas:

- *Universality.* All physically realizable computing devices can be simulated by a Turing machine. This idea is known as the *Church-Turing thesis*. This is a statement about the natural world and cannot be proven (but it can be falsified). The evidence in favor of the thesis is that mathematicians and computer scientists have developed numerous models of computation, but they all have been proven equivalent to the Turing machine.
- *Computability.* There exist problems that cannot be solved by a Turing machine (or by any other computing device, by universality). This is a mathematical truth. The halting problem (no program can guarantee to determine whether a given program will halt) is a famous example of such a problem.

In the present context, we are interested in a third idea, which speaks to the efficiency of computing devices:

- *Extended Church-Turing thesis.* The order of growth of the running time of a program to solve a problem on any computing device is within a polynomial factor of some program to solve the problem on a Turing machine (or any other computing device).

Again, this is a statement about the natural world, buttressed by the idea that all known computing devices can be simulated by a Turing machine, with at most a polynomial factor increase in cost. In recent years, the idea of *quantum computing* has given some researchers reason to doubt the extended Church-Turing thesis. Most agree that, from a practical point of view, it is probably safe for some time, but many researchers are hard at work on trying to falsify the thesis.

Exponential running time. The purpose of the theory of intractability is to separate problems that can be solved in polynomial time from problems that (probably) require *exponential* time to solve in the worst case. It is useful to think of an exponential-time algorithm as one that, for some input of size N , takes time proportional to 2^N (at least). The substance of the argument does not change if we replace 2 by any number $\alpha > 1$. We generally take as granted that an exponential-time algorithm cannot be guaranteed to solve a problem of size 100 (say) in a reasonable amount of time, because no one can wait for an algorithm to take 2^{100} steps, regardless of the speed of the computer. Exponential growth dwarfs technological changes: a supercomputer may be a trillion times faster than an abacus, but neither can come close to solving a problem that requires 2^{100} steps. Sometimes the line between “easy” and “hard” problems is a fine one. For example, we studied an algorithm in SECTION 4.1 that can solve the following problem:

Shortest-path length. What is the length of the shortest path from a given vertex s to a given vertex t in a given graph?

But we did not study algorithms for the following problem, which seems to be virtually the same:

Longest-path length. What is the length of the longest simple path from a given vertex s to a given vertex t in a given graph?

```
public class LongestPath
{
    private boolean[] marked;
    private int max;

    public LongestPath(Graph G, int s, int t)
    {
        marked = new boolean[G.V()];
        dfs(G, s, t, 0);
    }

    private void dfs(Graph G, int v, int t, int i)
    {
        if (v == t && i > max) max = i;
        if (v == t) return;
        marked[v] = true;
        for (int w : G.adj(v))
            if (!marked[w]) dfs(G, w, t, i+1);
        marked[v] = false;
    }

    public int maxLength()
    { return max; }
}
```

Finding the length of the longest path in a graph

The crux of the matter is this: as far as we know, these problems are nearly at opposite ends of the spectrum with respect to difficulty. Breadth-first search yields a solution for the first problem in *linear* time, but all known algorithms for the second problem take *exponential* time in the worst case. The code at the bottom of the previous page shows a variant of depth-first search that accomplishes the task. It is quite similar to depth-first search, but it examines *all* simple paths from s to t in the digraph to find the longest one.

Search problems. The great disparity between problems that can be solved with “efficient” algorithms of the type we have been studying in this book and problems where we need to look for a solution among a potentially huge number of possibilities makes it possible to study the interface between them with a simple formal model. The first step is to characterize the type of problem that we study:

Definition. A *search problem* is a problem having solutions with the property that the time needed to *certify* that any solution is correct is bounded by a polynomial in the size of the input. We say that an algorithm *solves* a search problem if, given any input, it either produces a solution or reports that none exists.

Four particular problems that are of interest in our discussion of intractability are shown at the top of the facing page. These problems are known as *satisfiability* problems. Now, all that is required to establish that a problem is a search problem is to show that any solution is sufficiently well-characterized that you can efficiently certify that it is correct. Solving a search problem is like searching for a “needle in a haystack” with the sole proviso that you can recognize the needle when you see it. For example, if you are given an assignment of values to variables in each of the satisfiability problems at the top of page 913, you easily can certify that each equality or inequality is satisfied, but searching for such an assignment is a totally different task. The name **NP** is commonly used to describe search problems—we will describe the reason for the name on page 914:

Definition. **NP** is the set of all search problems.

NP is nothing more than a precise characterization of all the problems that scientists, engineers, and applications programmers *aspire to solve* with programs that are guaranteed to finish in a feasible amount of time.

Linear equation satisfiability. Given a set of M linear equations involving N variables, find an assignment of values to the variables that satisfies all of the equations, or report that none exists.

Linear inequality satisfiability (search formulation of linear programming). Given a set of M linear inequalities involving N variables, find an assignment of values to the variables that satisfies all of the inequalities, or report that none exists.

0-1 integer linear inequality satisfiability (search formulation of 0-1 integer linear programming). Given a set of M linear inequalities involving N integer variables, find an assignment of the values 0 or 1 to the variables that satisfies all of the inequalities, or report that none exists.

Boolean satisfiability. Given a set of M equations involving *and* and *or* operations on N boolean variables, find an assignment of values to the variables that satisfies all of the equations, or report that none exists.

Selected search problems

Other types of problems. The concept of search problems is one of many ways to characterize the set of problems that form the basis of the study of intractability. Other possibilities are *decision* problems (does a solution exist?) and *optimization* problems (what is the best solution)? For example, the longest-paths length problem on page 911 is an optimization problem, not a search problem (given a solution, we have no way to verify that it is a longest-path length). A search version of this problem is to *find* a simple path connecting all the vertices (this problem is known as the *Hamiltonian path problem*). A decision version of the problem is to ask whether *there exists* a simple path connecting all the vertices. Arbitrage, boolean satisfiability, and Hamiltonian path are search problems; to ask whether a solution exists to any of these problems is a decision problem; and shortest/longest paths, maxflow, and linear programming are all optimization problems. While not technically equivalent, search, decision, and optimization problems typically reduce to one another (see EXERCISE 6.58 and 6.59) and the main conclusions we draw apply to all three types of problems.

Easy search problems. The definition of **NP** says nothing about the difficulty of *finding* the solution, just certifying that it is a solution. The second of the two sets of problems that form the basis of the study of intractability, which is known as **P**, is concerned with the difficulty of finding the solution. In this model, the efficiency of an algorithm is a function of the number of bits used to encode the input.

Definition. **P** is the set of all search problems that can be solved in polynomial time.

Implicit in the definition is the idea that the polynomial time bound is a *worst-case* bound. For a problem to be in **P**, there must exist an algorithm that can *guarantee* to solve it in polynomial time. Note that the polynomial is not specified at all. Linear, linearithmic, quadratic, and cubic are all polynomial time bounds, so this definition certainly covers the standard algorithms we have studied so far. The time taken by an algorithm depends on the computer used, but the extended Church-Turing thesis renders that point moot—it says that a polynomial-time solution on any computing device implies the existence of a polynomial-time solution on any other computing device. Sorting belongs to **P** because (for example) insertion sort runs in time proportional to N^2 (the existence of linearithmic sorting algorithms is not relevant in this context), as does shortest paths, linear equation satisfiability, and many others. Having an efficient algorithm to solve a problem is a proof that the problem is in **P**. In other words, **P** is nothing more than a precise characterization of all the problems that scientists, engineers, and applications programmers *do solve* with programs that are guaranteed to finish in a feasible amount of time.

Nondeterminism. The **N** in **NP** stands for *nondeterminism*. It represents the idea that one way (in theory) to extend the power of a computer is to endow it with the power of nondeterminism: to assert that when an algorithm is faced with a choice of several options, it has the power to “guess” the right one. For the purposes of our discussion, we can think of an algorithm for a nondeterministic machine as “guessing” the solution to a problem, then certifying that the solution is valid. In a Turing machine, nondeterminism is as simple as defining two different successor states for a given state and a given input and characterizing solutions as all legal paths to the desired result. Nondeterminism may be a mathematical fiction, but it is a useful idea. For example, in SECTION 5.4, we used nondeterminism as a tool for algorithm design—our regular expression pattern-matching algorithm is based on efficiently simulating a nondeterministic machine.

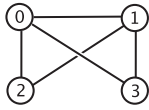
problem	input	description	poly-time algorithm	instance	solution
<i>Hamiltonian path</i>	graph G	find a simple path that visits every vertex	?		0-2-1-3
<i>factoring</i>	integer x	find a nontrivial factor of x	?	97605257271	8784561
<i>0-1 linear inequality satisfiability</i>	M 0-1 variables N inequalities	assign values to the variables that satisfy the inequalities	?	$x - y \leq 1$ $2x - z \leq 2$ $x + y \geq 2$ $z \geq 0$	$x = 1$ $y = 1$ $z = 0$
<i>all problems in P</i>		see table below			

Examples of problems in NP

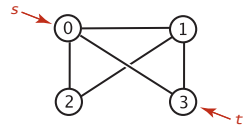
problem	input	description	poly-time algorithm	instance	solution
<i>shortest st-path</i>	graph G vertices s, t	find the shortest path from s to t	BFS		0-3
<i>sorting</i>	array a	find a permutation that puts a in ascending order	mergesort	2.8 8.5 4.1 1.3	3 0 2 1
<i>linear equation satisfiability</i>	M variables N equations	assign values to the variables that satisfy the equations	Gaussian elimination	$x + y = 1.5$ $2x - y = 0$	$x = 0.5$ $y = 1$
<i>linear inequality satisfiability</i>	M variables N inequalities	assign values to the variables that satisfy the inequalities	ellipsoid	$x - y \leq 1.5$ $2x - z \leq 0$ $x + y \geq 3.5$ $z \geq 4.0$	$x = 2.0$ $y = 1.5$ $z = 4.0$

Examples of problems in P

The main question. Nondeterminism is such a powerful notion that it seems almost absurd to consider it seriously. Why bother considering an imaginary tool that makes difficult problems seem trivial? The answer is that, powerful as nondeterminism may seem, no one has been able to *prove* that it helps for any particular problem! Put another way, no one has been able to find a single problem that can be proven to be in **NP** but not in **P** (or even prove that one exists), leaving the following question open:

Does $P = NP$?

This question was first posed in a famous letter from K. Gödel to J. von Neumann in 1950 and has completely stumped mathematicians and computer scientists ever since. Other ways of posing the question shed light on its fundamental nature:

- Are there *any* hard-to-solve search problems?
- Would we be able to solve some search problems more efficiently if we could build a nondeterministic computing device?

Not knowing the answers to these questions is extremely frustrating because many important practical problems belong to **NP** but may or may not belong to **P** (the best known deterministic algorithms could take exponential time). If we could prove that a problem does not belong to **P**, then we could abandon the search for an efficient solution to it. In the absence of such a proof, there is the possibility that some efficient algorithm has gone undiscovered. In fact, given the current state of our knowledge, there could be some efficient algorithm for *every* problem in **NP**, which would imply that many efficient algorithms have gone undiscovered. Virtually no one believes that $P = NP$, and a considerable amount of effort has gone into proving the contrary, but this remains the outstanding open research problem in computer science.

Poly-time reductions. Recall from page 903 that we show that a problem A *reduces* to another problem B by demonstrating that we can solve any instance of A in three steps:

- Transform it to an instance of B .
- Solve that instance of B .
- Transform the solution of B to be a solution of A .

As long as we can perform the transformations (and solve B) efficiently, we can solve A efficiently. In the present context, for *efficient* we use the weakest conceivable definition: to solve A we solve at most a polynomial number of instances of B , using transformations that require at most polynomial time. In this case, we say that A *poly-time reduces* to B . Before, we used reduction to introduce the idea of problem-solving models that can significantly expand the range of problems that we can solve with efficient algorithms. Now, we use reduction in another sense: *to prove a problem to be hard to solve*. If a problem A is known to be hard to solve, and A poly-time reduces to B , then B must be hard to solve, too. Otherwise, a guaranteed polynomial-time solution to B would give a guaranteed polynomial-time solution to A .

Proposition L. Boolean satisfiability poly-time reduces to 0-1 integer linear inequality satisfiability.

Proof: Given an instance of boolean satisfiability, define a set of inequalities with one 0-1 variable corresponding to each boolean variable and one 0-1 variable corresponding to each clause, as illustrated in the example at right. With this construction, we can transform a solution to the integer 0-1 linear inequality satisfiability problem to a solution to the boolean satisfiability problem by assigning each boolean variable to be *true* if the corresponding integer variable is 1 and *false* if it is 0.

Corollary. If satisfiability is hard to solve, then so is integer linear programming.

This statement is a meaningful statement about the relative difficulty of solving these two problems even in the absence of a precise definition of *hard to solve*. In the present context, by “hard to solve,” we mean “not in **P**.” We generally use the word *intractable* to refer to problems that are not in **P**. Starting with the seminal work of R. Karp in 1972, researchers have shown literally tens of thousands of problems from a wide variety of applications areas to be related by reduction relationships of this sort. Moreover, these relationships imply much more than just relationships between the individual problems, a concept that we now address.

NP-completeness. Many, many problems are known to belong to **NP** but probably do not belong to **P**. That is, we can easily *certify* that any given solution is valid, but, despite considerable effort, no one has been able to develop an efficient algorithm to *find* a solution. Remarkably, all of these many, many problems have an additional property that provides convincing evidence that **P** ≠ **NP**:

boolean satisfiability problem

$$(x_1 \text{ or } x_2 \text{ or } x_3) \text{ and} \\ (x_1 \text{ or } x_2' \text{ or } x_3) \text{ and} \\ (x_1' \text{ or } x_2' \text{ or } x_3') \text{ and} \\ (x_1' \text{ or } x_2' \text{ or } x_3)$$

0-1 integer linear inequality satisfiability formulation

$$\begin{aligned} c_1 \text{ is } 1 & \quad c_1 \geq 1 - x_1 \\ \text{if and only if} & \quad c_1 \geq x_2 \\ \text{first clause is} & \quad c_1 \geq x_3 \\ \text{satisfiable} & \quad c_1 \leq (1 - x_1) + x_2 + x_3 \\ & \quad c_2 \geq x_1 \\ & \quad c_2 \geq 1 - x_2 \\ & \quad c_2 \geq x_3 \\ & \quad c_2 \leq x_1 + (1 - x_2) + x_3 \\ & \quad c_3 \geq 1 - x_1 \\ & \quad c_3 \geq 1 - x_2 \\ & \quad c_3 \geq 1 - x_3 \\ & \quad c_3 \leq (1 - x_1) + 1 - x_2 + (1 - x_3) \\ & \quad c_4 \geq 1 - x_1 \\ & \quad c_4 \geq 1 - x_2 \\ & \quad c_4 \geq x_3 \\ & \quad c_4 \leq (1 - x_1) + (1 - x_2) + x_3 \\ & \quad s \leq c_1 \\ & \quad s \leq c_2 \\ & \quad s \leq c_3 \\ & \quad s \leq c_4 \\ & \quad s \geq c_1 + c_2 + c_3 + c_4 - 3 \end{aligned}$$

Example of reducing boolean satisfiability to 0-1 integer linear inequality satisfiability

s is 1 if and only if c's are all 1

Definition. A search problem A is said to be **NP-complete** if all problems in **NP** poly-time reduce to A .

This definition enables us to upgrade our definition of “hard to solve” to mean “intractable unless $P = NP$.” If *any* **NP**-complete problem can be solved in polynomial time on a deterministic machine, then so can *all problems in NP* (i.e., $P = NP$). That is, the collective failure of all researchers to find efficient algorithms for all of these problems might be viewed as a collective failure to prove that $P = NP$. **NP**-complete problems, meaning that we do not expect to find guaranteed polynomial-time algorithms. Most practical search problems are known to be either in **P** or **NP**-complete.

Cook-Levin theorem. Reduction uses the **NP**-completeness of one problem to imply the **NP**-completeness of another. But reduction cannot be used in one case: how was the *first* problem proven to be **NP**-complete? This was done independently by S. Cook and L. Levin in the early 1970s.

Proposition M. (Cook-Levin theorem) Boolean satisfiability is **NP**-complete.

Extremely brief proof sketch: The goal is to show that if there is a polynomial time algorithm for boolean satisfiability, then all problems in **NP** can be solved in polynomial time. Now, a nondeterministic Turing machine can solve any problem in **NP**, so the first step in the proof is to describe each feature of the machine in terms of logical formulas such as appear in the boolean satisfiability problem. This construction establishes a correspondence between every problem in **NP** (which can be expressed as a program on the nondeterministic Turing machine) and some instance of satisfiability (the translation of that program into a logical formula). Now, the solution to the satisfiability problem essentially corresponds to a simulation of the machine running the given program on the given input, so it produces a solution to an instance of the given problem. Further details of this proof are well beyond the scope of this book. Fortunately, only one such proof is really necessary: it is much easier to use reduction to prove **NP**-completeness.

The Cook-Levin theorem, in conjunction with the thousands and thousands of poly-time reductions from **NP**-complete problems that have followed it, leaves us with two possible universes: either $P = NP$ and no intractable search problems exist (all search problems can be solved in polynomial time); or $P \neq NP$, there do exist intractable search problems (some search problems cannot be solved in polynomial time). **NP**-complete

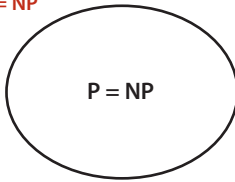
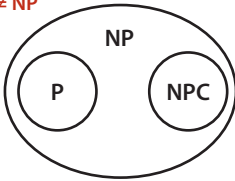
$P = NP$  $P \neq NP$ 

Two possible universes

problems arise frequently in important natural practical applications, so there has been strong motivation to find good algorithms to solve them. The fact that no good algorithm has been found for any of these problems is surely strong evidence that $P \neq NP$, and most researchers certainly believe this to be the case. On the other hand, the fact that no one has been able to prove that any of these problems do not belong to P could be construed to comprise a similar body of circumstantial evidence on the other side. Whether or not $P = NP$, the practical fact is that the best known algorithm for any of the NP -complete problems takes exponential time in the worst case.

Classifying problems. To prove that a search problem is in P , we need to exhibit a polynomial-time algorithm for solving it, perhaps by reducing it to a problem known to be in P . To prove that a problem in NP is NP -complete, we need to show that some known NP -complete problem is poly-time reducible to it: that is, that a polynomial-time algorithm for the new problem could be used to solve the NP -complete problem, and then could, in turn, be used to solve all problems in NP . Thousands and thousands of problems have been shown to be NP -complete in this way, as we did for integer linear programming in PROPOSITION L. The list on page 920, which includes several of the problems addressed by Karp, is representative, but contains only a tiny fraction of the known NP -complete problems. Classifying problems as being easy to solve (in P) or hard to solve (NP -complete) can be:

- *Straightforward.* For example, the venerable Gaussian elimination algorithm proves that linear equation satisfiability is in P .
- *Tricky but not difficult.* For example, developing a proof like the proof of PROPOSITION A takes some experience and practice, but it is easy to understand.
- *Extremely challenging.* For example, linear programming was long unclassified, but Khachian's ellipsoid algorithm proves that linear programming is in P .
- *Open.* For example, *graph isomorphism* (given two graphs, find a way to rename the vertices of one to make it identical to the other) and *factor* (given an integer, find a nontrivial factor) are still unclassified.

This is a rich and active area of current research, still involving thousands of research papers per year. As indicated by the last few entries on the list on page 920, all areas of scientific inquiry are affected. Recall that our definition of NP encompasses the problems that scientists, engineers, and applications programmers *aspire to solve* feasibly—all such problems certainly need to be classified!

Boolean satisfiability. Given a set of M equations involving N boolean variables, find an assignment of values to the variables that satisfies all of the equations, or report that none exists.

Integer linear programming. Given a set of M linear inequalities involving N integer variables, find an assignment of values to the variables that satisfies all of the inequalities, or report that none exists.

Load balancing. Given a set of jobs of specified duration to be completed and a time bound T , how can we schedule the jobs on two identical processors so as to complete them all by time T ?

Vertex cover. Given a graph and an integer C , find a set of C vertices such that each edge of the graph is incident to at least one vertex of the set.

Hamiltonian path. Given a graph, find a simple path that visits each vertex exactly once, or report that none exists.

Protein folding. Given energy level M , find a folded three-dimensional conformation of a protein having potential energy less than M .

Ising model. Given an Ising model on a lattice of dimension three and an energy threshold E , is there a subgraph with free energy less than E ?

Risk portfolio of a given return. Given an investment portfolio with a given total cost, a given return, risk values assigned to each investment, and a threshold M , find a way to allocate the investments such that the risk is less than M .

Some famous NP-complete problems

Coping with NP-completeness. Some sort of solution to this vast panoply of problems must be found in practice, so there is intense interest in finding ways to address them. It is impossible to do justice to this vast field of study in one paragraph, but we can briefly describe various approaches that have been tried. One approach is to change the problem and find an “approximation” algorithm that finds not the best solution but a solution guaranteed to be close to the best. For example, it is easy to find a solution to the Euclidean traveling salesperson problem that is within a factor of 2 of the optimal. Unfortunately, this approach is often not sufficient to ward off **NP**-completeness, when seeking improved approximations. Another approach is to develop an algorithm that solves efficiently virtually all of the instances that do arise in practice, even though there exist worst-case inputs for which finding a solution is infeasible. The most famous example of this approach are the integer linear programming solvers, which have been workhorses for many decades in solving huge optimization problems in countless industrial applications. Even though they could require exponential time, the inputs that arise in practice evidently are not worst-case inputs. A third approach is to work with “efficient” exponential algorithms, using a technique known as *backtracking* to avoid having to check all possible solutions. Finally, there is quite a large gap between polynomial and exponential time that is not addressed by the theory. What about an algorithm that runs in time proportional to $N^{\log N}$ or $2^{\sqrt{N}}$?

ALL THE APPLICATIONS AREAS we have studied in this book are touched by **NP**-completeness: **NP**-complete problems arise in elementary programming, in sorting and searching, in graph processing, in string processing, in scientific computing, in systems programming, in operations research, and in any conceivable area where computing plays a role. The most important practical contribution of the theory of **NP**-completeness is that it provides a mechanism to discover whether a new problem from any of these diverse areas is “easy” or “hard.” If one can find an efficient algorithm to solve a new problem, then there is no difficulty. If not, a proof that the problem is **NP**-complete tells us that developing an efficient algorithm would be a stunning achievement (and suggests that a different approach should perhaps be tried). The scores of efficient algorithms that we have examined in this book are testimony that we have learned a great deal about efficient computational methods since Euclid, but the theory of **NP**-completeness shows that, indeed, we still have a great deal to learn.

EXERCISES on collision simulation

- 6.1** Complete the implementation `predictCollisions()` and `Particle` as described in the text. There are three equations governing the elastic collision between a pair of hard discs: (a) conservation of linear momentum, (b) conservation of kinetic energy, and (c) upon collision, the normal force acts perpendicular to the surface at the collision point (assuming no friction or spin). See the booksite for more details.
- 6.2** Develop a version of `CollisionSystem`, `Particle`, and `Event` that handles multi-particle collisions. Such collisions are important when simulating the break in a game of billiards. (This is a difficult exercise!)
- 6.3** Develop a version of `CollisionSystem`, `Particle`, and `Event` that works in three dimensions.
- 6.4** Explore the idea of improving the performance of `simulate()` in `CollisionSystem` by dividing the region into rectangular cells and adding a new event type so that you only need to predict collisions with particles in one of nine adjacent cells in any time quantum. This approach reduces the number of predictions to calculate at the cost of monitoring the movement of particles from cell to cell.
- 6.5** Introduce the concept of *entropy* to `CollisionSystem` and use it to confirm classical results.
- 6.6** *Brownian motion.* In 1827, the botanist Robert Brown observed the motion of wildflower pollen grains immersed in water using a microscope. He observed that the pollen grains were in a random motion, following what would become known as Brownian motion. This phenomenon was discussed, but no convincing explanation was provided until Einstein provided a mathematical one in 1905. Einstein's explanation: the motion of the pollen grain particles was caused by millions of tiny molecules colliding with the larger particles. Run a simulation that illustrates this phenomenon.
- 6.7** *Temperature.* Add a method `temperature()` to `Particle` that returns the product of its mass and the square of the magnitude of its velocity divided by dk_B where $d=2$ is the dimension and $k_B = 1.3806503 \times 10^{-23}$ is Boltzmann's constant. The temperature of the system is the average value of these quantities. Then add a method `temperature()` to `CollisionSystem` and write a driver that plots the temperature periodically, to check that it is constant.

6.8 *Maxwell-Boltzmann.* The distribution of velocity of particles in the hard disc model obeys the *Maxwell-Boltzmann distribution* (assuming that the system has thermalized and particles are sufficiently heavy that we can discount quantum-mechanical effects), which is known as the Rayleigh distribution in two dimensions. The distribution shape depends on temperature. Write a driver that computes a histogram of the particle velocities and test it for various temperatures.

6.9 *Arbitrary shape.* Molecules travel very quickly (faster than a speeding jet) but diffuse slowly because they collide with other molecules, thereby changing their direction. Extend the model to have a boundary shape where two vessels are connected by a pipe containing two different types of particles. Run a simulation and measure the fraction of particles of each type in each vessel as a function of time.

6.10 *Rewind.* After running a simulation, negate all velocities and then run the system backward. It should return to its original state! Measure roundoff error by measuring the difference between the final and original states of the system.

6.11 *Pressure.* Add a method `pressure()` to `Particle` that measures pressure by accumulating the number and magnitude of collisions against walls. The pressure of the system is the sum of these quantities. Then add a method `pressure()` to `CollisionSystem` and write a client that validates the equation $pV = nRT$.

6.12 *Index priority queue implementation.* Develop a version of `CollisionSystem` that uses an index priority queue to guarantee that the size of the priority queue is at most linear in the number of particles (instead of quadratic or worse).

6.13 *Priority queue performance.* Instrument the priority queue and test `Pressure` at various temperatures to identify the computational bottleneck. If warranted, try switching to a different priority-queue implementation for better performance at high temperatures.

EXERCISES on B-Trees

- 6.14** Suppose that, in a three-level tree, we can afford to keep a links in internal memory, between b and $2b$ links in pages representing internal nodes, and between c and $2c$ items in pages representing external nodes. What is the maximum number of items that we can hold in such a tree, as a function of a , b , and c ?
- 6.15** Develop an implementation of `Page` that represents each B-tree node as a `BinarySearchST` object.
- 6.16** Extend `BTreeSET` to develop a `BTreeST` implementation that associates keys with values and supports our full ordered symbol table API that includes `min()`, `max()`, `floor()`, `ceiling()`, `deleteMin()`, `deleteMax()`, `select()`, `rank()`, and the two-argument versions of `size()` and `get()`.
- 6.17** Write a program that uses `StdDraw` to visualize B-trees as they grow, as in the text.
- 6.18** Estimate the average number of probes per search in a B-tree for S random searches, in a typical cache system, where the T most-recently-accessed pages are kept in memory (and therefore add 0 to the probe count). Assume that S is much larger than T .
- 6.19** *Web search.* Develop an implementation of `Page` that represents B-tree nodes as text files on web pages, for the purposes of indexing (building a concordance for) the web. Use a file of search terms. Take web pages to be indexed from standard input. To keep control, take a command-line parameter m , and set an upper limit of 10^m internal nodes (check with your system administrator before running for large m). Use an m -digit number to name your internal nodes. For example, when m is 4, your nodes names might be `BTreeNode0000`, `BTreeNode0001`, `BTreeNode0002`, and so forth. Keep pairs of strings on pages. Add a `close()` operation to the API, to sort and write. To test your implementation, look for yourself and your friends on your university's website.
- 6.20** *B* trees.* Consider the sibling split (or *B*-tree*) heuristic for B-trees: When it comes time to split a node because it contains M entries, we combine the node with its sibling. If the sibling has k entries with $k < M - 1$, we reallocate the items giving the sibling and the full node each about $(M+k)/2$ entries. Otherwise, we create a new node and give each of the three nodes about $2M/3$ entries. Also, we allow the root to grow to hold about $4M/3$ items, splitting it and creating a new root node with two entries when it reaches that bound. State bounds on the number of probes used for a search or an insertion in a B*-tree of order M with N items. Compare your bounds with the

corresponding bounds for B-trees (see PROPOSITION B). Develop an *insert* implementation for B*-trees.

6.21 Write a program to compute the average number of external pages for a B-tree of order M built from N random insertions into an initially empty tree. Run your program for reasonable values of M and N .

6.22 If your system supports virtual memory, design and conduct experiments to compare the performance of B-trees with that of binary search, for random searches in a huge symbol table.

6.23 For your internal-memory implementation of Page in EXERCISE 6.15, run experiments to determine the value of M that leads to the fastest search times for a B-tree implementation supporting random search operations in a huge symbol table. Restrict your attention to values of M that are multiples of 100.

6.24 Run experiments to compare search times for internal B-trees (using the value of M determined in the previous exercise), linear probing hashing, and red-black trees for random search operations in a huge symbol table.

EXERCISES on suffix arrays

6.25 Give, in the style of the figure on page 882, the suffixes, sorted suffixes, `index()` and `lcp()` tables for the following strings:

- a. abacadaba
- b. mississippi
- c. abcdefghij
- d. aaaaaaaaaa

6.26 Identify the problem with the following code fragment to compute all the suffixes for suffix sort:

```
suffix = "";
for (int i = s.length() - 1; i >= 0; i--)
{
    suffix = s.charAt(i) + suffix;
    suffixes[i] = suffix;
}
```

Answer: It uses quadratic time and quadratic space.

6.27 Some applications require a sort of *cyclic rotations* of a text, which all contain all the characters of the text. For i from 0 to $N - 1$, the i th cyclic rotation of a text of length N is the last $N - i$ characters followed by the first i characters. Identify the problem with the following code fragment to compute all the cyclic rotations:

```
int N = s.length();
for (int i = 0; i < N; i++)
    rotation[i] = s.substring(i, N) + s.substring(0, i);
```

Answer: It uses quadratic time and quadratic space.

6.28 Design a linear-time algorithm to compute all the cyclic rotations of a text string.

Answer:

```
String t = s + s;
int N = s.length();
for (int i = 0; i < N; i++)
    rotation[i] = r.substring(i, i + N);
```

6.29 Under the assumptions described in SECTION 1.4, give the memory usage of a `SuffixArray` object with a string of length N .

6.30 *Longest common substring.* Write a `SuffixArray` client `LCS` that take two file-names as command-line arguments, reads the two text files, and finds the longest substring that appears in both in linear time. (In 1970, D. Knuth conjectured that this task was impossible.) *Hint:* Create a suffix array for `s#t` where `s` and `t` are the two text strings and `#` is a character that does not appear in either.

6.31 *Burrows-Wheeler transform.* The *Burrows-Wheeler transform* (BWT) is a transformation that is used in data compression algorithms, including `bzip2` and in high-throughput sequencing in genomics. Write a `SuffixArray` client that computes the BWT in linear time, as follows: Given a string of length N (terminated by a special end-of-file character `$` that is smaller than any other character), consider the N -by- N matrix in which each row contains a different cyclic rotation of the original text string. Sort the rows lexicographically. The Burrows-Wheeler transform is the rightmost column in the sorted matrix. For example, the BWT of `mississippi$` is `ipssm$piissii`. The *Burrows-Wheeler inverse transform* (BWI) inverts the BWT. For example, the BWI of `ipssm$piissii` is `mississippi$`. Also write a client that, given the BWT of a text string, computes the BWI in linear time.

6.32 *Circular string linearization.* Write a `SuffixArray` client that, given a string, finds the cyclic rotation that is the smallest lexicographically in linear time. This problem arises in chemical databases for circular molecules, where each molecule is represented as a circular string, and a canonical representation (smallest cyclic rotation) is used to support search with any rotation as key. (See EXERCISE 6.27 and EXERCISE 6.28.)

6.33 *Longest k -repeated substring.* Write a `SuffixArray` client that, given a string and an integer k , find the longest substring that is repeated k or more times.

6.34 *Long repeated substrings.* Write a `SuffixArray` client that, given a string and an integer L , finds all repeated substrings of length L or more.

6.35 *k -gram frequency counts.* Develop and implement an ADT for preprocessing a string to support efficiently answering queries of the form *How many times does a given k -gram appear?* Each query should take time proportional to $k \log N$ in the worst case, where N is the length of the string.

EXERCISES on maxflow

- 6.36** If capacities are positive integers less than M , what is the maximum possible flow value for any st -network with V vertices and E edges? Give two answers, depending on whether or not parallel edges are allowed.
- 6.37** Give an algorithm to solve the maxflow problem for the case that the network forms a tree if the sink is removed.
- 6.38** *True or false.* If true provide a short proof, if false give a counterexample:
- In any max flow, there is no directed cycle on which every edge carries positive flow
 - There exists a max flow for which there is no directed cycle on which every edge carries positive flow
 - If all edge capacities are distinct, the max flow is unique
 - If all edge capacities are increased by an additive constant, the min cut remains unchanged
 - If all edge capacities are multiplied by a positive integer, the min cut remains unchanged
- 6.39** Complete the proof of PROPOSITION G: Show that each time an edge is a critical edge, the length of the augmenting path through it must increase by 2.
- 6.40** Find a large network online that you can use as a vehicle for testing flow algorithms on realistic data. Possibilities include transportation networks (road, rail, or air), communications networks (telephone or computer connections), or distribution networks. If capacities are not available, devise a reasonable model to add them. Write a program that uses the interface to implement flow networks from your data. If warranted, develop additional private methods to clean up the data.
- 6.41** Write a random-network generator for sparse networks with integer capacities between 0 and 2^{20} . Use a separate class for capacities and develop two implementations: one that generates uniformly distributed capacities and another that generates capacities according to a Gaussian distribution. Implement client programs that generate random networks for both weight distributions with a well-chosen set of values of V and E so that you can use them to run empirical tests on graphs drawn from various distributions of edge weights.

6.42 Write a program that generates V random points in the plane, then builds a flow network with edges (in both directions) connecting all pairs of points within a given distance d of each other, setting each edge's capacity using one of the random models described in the previous exercise.

6.43 *Basic reductions.* Develop FordFulkerson clients for finding a maxflow in each of the following types of flow networks:

- Undirected
- No constraint on the number of sources or sinks or on edges entering the source or leaving the sink
- Lower bounds on capacities
- Capacity constraints on vertices

6.44 *Product distribution.* Suppose that a flow represents products to be transferred by trucks between cities, with the flow on edge $u-v$ representing the amount to be taken from city u to city v in a given day. Write a client that prints out daily orders for truckers, telling them how much and where to pick up and how much and where to drop off. Assume that there are no limits on the supply of truckers and that nothing leaves a given distribution point until everything has arrived.

6.45 *Job placement.* Develop a FordFulkerson client that solves the job-placement problem, using the reduction in PROPOSITION J. Use a symbol table to convert symbolic names into integers for use in the flow network.

6.46 Construct a family of bipartite matching problems where the average length of the augmenting paths used by any augmenting-path algorithm to solve the corresponding maxflow problem is proportional to E .

6.47 *st -connectivity.* Develop a FordFulkerson client that, given an undirected graph G and vertices s and t , finds the minimum number of edges in G whose removal will disconnect t from s .

6.48 *Disjoint paths.* Develop a FordFulkerson client that, given an undirected graph G and vertices s and t , finds the maximum number of edge-disjoint paths from s to t .

EXERCISES on reductions and intractability

- 6.49** Find a nontrivial factor of 37703491.
- 6.50** Prove that the shortest-paths problem reduces to linear programming.
- 6.51** Could there be an algorithm that solves an **NP**-complete problem in an average time of $N^{\log N}$, if $\mathbf{P} \neq \mathbf{NP}$? Explain your answer.
- 6.52** Suppose that someone discovers an algorithm that is guaranteed to solve the boolean satisfiability problem in time proportional to 1.1^N . Does this imply that we can solve other **NP**-complete problems in time proportional to 1.1^N ?
- 6.53** What would be the significance of a program that could solve the integer linear programming problem in time proportional to 1.1^N ?
- 6.54** Give a poly-time reduction from vertex cover to 0-1 integer linear inequality satisfiability.
- 6.55** Prove that the problem of finding a Hamiltonian path in a *directed* graph is **NP**-complete, using the **NP**-completeness of the Hamiltonian-path problem for undirected graphs.
- 6.56** Suppose that two problems are known to be **NP**-complete. Does this imply that there is a poly-time reduction from one to the other?
- 6.57** Suppose that X is **NP**-complete, X poly-time reduces to Y , and Y poly-time reduces to X . Is Y necessarily **NP**-complete?
- Answer:* No, since Y may not be in **NP**.
- 6.58** Suppose that we have an algorithm to solve the decision version of boolean satisfiability, which indicates that there exists an assignment of truth values to the variables that satisfies the boolean expression. Show how to find the assignment.
- 6.59** Suppose that we have an algorithm to solve the decision version of the vertex cover problem, which indicates that there exists a vertex cover of a given size. Show how to solve the optimization version of finding the vertex cover of minimum cardinality.
- 6.60** Explain why the optimization version of the vertex cover problem is not necessarily a search problem.

Answer: There does not appear to be an efficient way to certify that a purported solution is the best possible (even though we could use binary search on the search version of the problem to find the best solution).

6.61 Suppose that X and Y are two search problems and that X poly-time reduces to Y . Which of the following can we infer?

- a. If Y is **NP**-complete then so is X .
- b. If X is **NP**-complete then so is Y .
- c. If X is in P , then Y is in P .
- d. If Y is in P , then X is in P .

6.62 Suppose that $P \neq NP$. Which of the following can we infer?

- e. If X is **NP**-complete, then X cannot be solved in polynomial time.
- f. If X is in **NP**, then X cannot be solved in polynomial time.
- g. If X is in **NP** but not **NP**-complete, then X can be solved in polynomial time.
- h. If X is in P , then X is not **NP**-complete.



Index

Symbols

2-3-4 search tree 441, 451
2-3 search tree 424–431
 2-nodes and 3-nodes 424
 analysis of 429
 defined 424
 height 429
 insertion 425–427
 order 424
 perfect balance 424
 and red-black BST 432
 search 425
2-3 tree. *See* 2-3 search tree
2-colorability problem 546
2-dimensional array 19
2-satisfiability problem 599
2-sum problem 189
3-collinear problem 211
3-sum problem 173, 190
3-way partitioning 298
3-way quicksort 298–301
3-way string quicksort 719–723
8-puzzle problem 358
32-bit architecture 13, 201, 212
64-bit architecture 13, 201

A

A* algorithm 350
Abstract data type 64
 API 65
 client 88–89
 design 96–97
 implementing an 84–87
 multiple implementations 90
Abstract in-place merge 270
Accumulator data type 92–93
Actual type 134, 328
Acyclic digraph.
 See Directed acyclic graph
Acyclic edge-weighted digraph.
 See Edge-weighted DAG
Acyclic graph 520, 547, 576
Adjacency list
 directed graph 568–569
 edge-weighted digraph 644
 edge-weighted graph 609
 undirected graph 524–525
Adjacency matrix 524, 527
Adjacency set 527
Adjacent vertex 519
ADT. *See* Abstract data type

Algorithm
 century of 853
 defined 4
 deterministic 4
 nondeterministic 914
 randomized 198
Aliasing
 of arrays 19
 of objects 69
 of substrings 202
All-pairs reachability 590
All-pairs shortest paths 656
Alphabet data type 698–700
Amortized analysis
 binary heap 320
 defined 198–199
 hash table 475
 resizing array 199
 union-find 231, 237
 weighted quick-union with
 path compression 231
Analysis of algorithms 172–215.
 See also Propositions;
 See also Properties
 amortized analysis 198–199
 big-Oh notation 206–207

- cost model 182
- divide-and-conquer 272
- doubling ratio 192–193
- doubling test 176–177
- input models 197
- log-log plot 176
- mathematical models 178
- memory usage 200–204
- multiple parameters 196
- observations 173–175
- order-of-growth 179
- order-of-growth classifica-
tions 186–188
- order-of-growth hypoth-
esis 180
- problem size 173
- randomized algorithm 198
- scientific method 172
- tilde approximation 178
- worst-case guarantee 197
- Antisymmetric relation 247
- APIs
 - Accumulator 93
 - Alphabet 698
 - Bag 121
 - BinaryStdIn 812
 - BinaryStdOut 812
 - Buffer 170
 - CC 543
 - Counter 65
 - Date 79
 - Degrees 596
 - Deque 167
 - Digraph 568
 - DirectedCycle 576
 - DirectedDFS 570
 - DirectedEdge 641
 - Draw 83
 - Edge 608
 - EdgeWeightedDigraph 641
 - EdgeWeightedGraph 608
 - FixedCapacityStack 135
 - FixedCapacityStackOf-
Strings 133
 - FlowEdge 890
 - FlowNetwork 890
 - GeneralizedQueue 169
 - Graph 522
 - GraphProperties 559
 - In 41, 83
 - IndexMaxPQ 320
 - IndexMinPQ 320
 - Interval1D 77
 - Interval2D 77
 - java.lang.Double 34
 - java.lang.Integer 34
 - java.lang.Math 28
 - java.lang.String 80
 - java.util.Arrays 29
 - KMP 769
 - List 511
 - MathSET 509
 - Matrix 60
 - MaxPQ 309
 - MinPQ 309
 - MST 613
 - Out 41, 83
 - Page 870
 - Particle 860
 - Paths 535
 - Point2D 77
 - Queue 121
 - RandomBag 167
 - RandomQueue 168
 - Rational 117
 - SCC 586
 - Search 528
 - SET 489
 - SP 644, 677
 - ST 363, 366, 860, 870, 879
 - Stack 121
 - StaticSETofInts 99
 - StdDraw 43
 - StdIn 39
 - StdOut 37
 - StdRandom 30
 - StdStats 30
 - Stopwatch 175
 - StringSET 754
 - StringST 730
 - SuffixArray 879
 - SymbolDigraph 581
 - SymbolGraph 548
 - Topological 578
 - Transaction 79
 - TransitiveClosure 592
 - UF 219
 - VisualAccumulator 95
- Application programming inter-
face. *See also* APIs
 - client 28
 - contract 33
 - data type definition 65
 - implementation 28
 - library of static methods 28
- Arbitrage detection 679–681
- Arithmetic expression evalua-
tion 128–131
- Array 18–21
 - 2-dimensional 19
 - aliasing 19
 - as object 72
 - bounds checking 19
 - memory usage of 202
 - of objects 72
 - ragged 19
- Array resizing. *See* Resizing array
- Arrays.sort() 29, 306
- Articulation point 562
- ASCII encoding 696, 815
- Assertion 107
- assert statement 107
- Assignment statement 14
- Associative array 363
- Augmenting path 891
- Autoboxing 122, 214
- AVL tree 452

B

- Backtracking 921
- Bag data type 124, 154–156
- Balanced search tree 424–457
 - 2-3 search tree 424–431
 - AVL tree 452
 - B-tree 866–874
 - red-black BST 432–447
- Base case 25
- Bellman-Ford 671–678
- Bellman, R. 683
- Bentley, J. 298, 306
- BFS. *See* Breadth-first search
- Biconnectivity 562
- Big-Oh notation 206–207
- Big-Omega notation 207
- Big-Theta notation 207
- Binary data 811–815
- Binary dump 813–814
- Binary heap 313–322
 - amortized analysis of 320
 - analysis of 319
 - change priority 321
 - defined 314
 - deletion 321
 - heapsort 323–327
 - insertion 317
 - remove the maximum 317
 - remove the minimum 321
 - representation 313
 - sink and swim 315–316
- Binary logarithm function 185
- Binary search 8
 - analysis of 383, 391
 - bitonic search 210
 - for a fraction 211
 - in a sorted array 46–47, 98–99
 - local minimum 210
 - symbol table 378–384
- Binary search tree 396–423
 - analysis of 403
 - anatomy of 396
- AVL tree 452
 - certification 419
 - defined 396
 - delete the min/max 408
 - floor and ceiling 406
 - height 412
 - Hibbard deletion 410, 422
 - insertion 400–401
 - minimum and maximum 406
 - nonrecursive 417
 - perfectly balanced 403
 - range query 412
 - rank and select 415
 - recursion 415
 - representation 397
 - rotation 433–434
 - search 397–401
 - selection and rank 406, 408
 - symmetric order 396
 - threading 420
- BinaryStdIn library 811–815
- BinaryStdOut library 811–815
- Binary tree
 - anatomy of 396
 - binary heap 313
 - complete 313, 314
 - decision tree 280
 - external path length 418
 - heap-ordered 313
 - height 314
 - inorder traversal 412
 - internal path length 412
 - level-order traversal 420
 - preorder traversal 834
 - weighted external path length 832
- Binomial coefficient 185
- Binomial distribution 59, 466
- Binomial tree 237
- Bipartite graph 521, 546–547
- Birthday problem 215
- Bitmap 822
- Bitonic array 210
- Bitonic search 210
- Bitonic shortest paths 689
- Blacklist filter 491
- Boerner's theorem 357
- boolean primitive data type 12
- Boolean satisfiability 913, 920
- Boruvka, O. 628
- Boruvka's algorithm 629, 636
- Bottleneck shortest paths 690
- Bottom-up 2-3-4 tree 451
- Bottom-up mergesort 277
- Boyer-Moore 770–773
- Boyer, R. S. 759
- Breadth-first search
 - in a digraph 573
 - in a graph 538–542
- break statement 15
- Bridge in a graph 562
- B-tree 448, 866–874
 - analysis of 871
 - insertion 868
 - perfect balance 868
 - search 868
- Buffer data type 170
- Byte (8 bits) 200
- byte primitive data type 13

C

- Cache 195, 307, 327, 343, 394, 419, 423
- Call a method 22
- Callback 339. *See also* Interface
- Cast 13, 328, 346
- Catenable queue 171
- Ceiling function
 - binary search tree 406
 - mathematical function 185
 - ordered array 380
 - symbol table 367
- Cell-probe model 234

- Center of a graph 559
- Certification
 - binary heap 330
 - binary search 392
 - binary search tree 419
 - minimum spanning tree 634
 - NP complexity class 912
 - red-black BST 452
 - search problem 912
 - shortest paths 651
 - sorting 246, 265
- char primitive data type 12, 696
- Chazelle, B. 629, 853
- Chebyshev's inequality 303
- Church-Turing thesis 910
- Circular linked list 165
- Circular queue 169
- Circular rotation 114
- Classpath 66
- Client 28
- Closest pair 210
- Collections 120
 - bag 124–125
 - catenable 171
 - deque 167
 - generalized queue 169
 - priority queue 308–334
 - pushdown stack 127
 - queue 126
 - random bag 167
 - random queue 168
 - ring buffer 169
 - stack 127
 - steque 167
 - symbol table 360–513
 - trie 730–757.
- Collision resolution 458
- Combinatorial search 912
- Command-line argument 36
- Command-line interface
 - command-line argument 36
 - compile a Java program 10
 - piping 40
 - redirection 40
 - run a Java program 10
 - standard input 39
 - standard output 37–38
 - terminal window 36
- Comma-separated-value 493
- Comparable interface
 - compareTo() method 246–247
 - Date 247
 - natural order 337
 - sorting 244, 246–247
 - String 353
 - symbol table 368–369
 - Transaction 266
- Comparator interface 338–340
 - compare() method 338–339
 - priority queue 340
 - Transaction 339
- compare() method.
 - See* Comparator interface
- compareTo() method.
 - See* Comparable interface
- Compile a program 10
- Compiler 492, 498
- Complete binary tree 314
- Complete graph 681
- Compression.
 - See* Data compression
- Computability 910
- Computational complexity
 - Cook-Levin theorem 918
 - intractability 910–921
 - NP**-complete 917–918
 - NP** 912
 - P** 914
 - P=NP** question 916
 - poly-time reduction 916–917
 - sorting 279–282
- Computational geometry 76
- Concatenation of strings 34
- Concordance 510
- Concrete type 122, 134
- Conditional statement 15
- Connected components
 - computing 543–546
 - defined 519
 - union-find 217
- Connected graph 519
- Connectivity
 - articulation point 562
 - biconnectivity 562
 - bridge 562
 - components 543–546
 - dynamic 216
 - edge-connected graph 562
 - strong connectivity 584–591
 - undirected graph 530
 - union-find 216–241
- Constant running time 186
- Constructor 65, 84–85
- continue statement 15
- Contract 33
- Cook-Levin theorem 918
- Cook, S. 759, 918
- Cost model 182.
 - array accesses 182, 220, 369
 - binary search 184
 - B-tree 866
 - compares 369
 - equality tests 369
 - searching 369
 - sorting 246
 - symbol table 369
 - 3-sum 182
 - union-find 220
- Coupon collector problem 215
- Covariant arrays 158
- CPM. *See* Critical-path method
- C language 104
- C++ language 104
- Critical edge 633, 690, 900
- Critical path 663
- Critical-path method 663, 664

- Crossing edge 606
 - Cubic running time 186
 - Cuckoo hashing 484
 - Cut 606.
 - See also* Mincut problem
 - capacity of 892
 - optimality conditions 634
 - property for MST 606
 - st*-cut 892
 - Cycle
 - Eulerian 562, 598
 - Hamiltonian 562
 - in a digraph 567
 - in a graph 519
 - odd length 562
 - simple 519, 567
 - Cycle detection 546–547
 - Cyclic rotation of a string 784
- D**
- DAG. *See* Directed acyclic graph
 - Dangling else 52
 - Dantzig, G. 909
 - Data abstraction 64–119
 - Data compression 810–851
 - fixed-length code 819–821
 - Huffman 826–838
 - lossless 811
 - lossy 811
 - LZW algorithm 839–845
 - prefix-free code 826–827
 - run-length encoding 822–825
 - 2-bit genomics code 819–821
 - undecidability 817
 - uniquely decodable code 826
 - universal 816
 - variable-length code 826
 - Data structure
 - adjacency lists 525
 - adjacency matrix 524
 - binary heap 313
 - binary search tree 396
 - binary tree 396
 - circular linked list 165
 - defined 4
 - doubly-linked list 146
 - linked list 142–146
 - multiway trie 732
 - ordered array 312
 - ordered list 312
 - parallel arrays 378
 - parent-link 225
 - resizing array 136
 - ternary search trie 746
 - unordered array 310
 - unordered list 312
 - Data type
 - abstract 64
 - design of 96–97
 - encapsulation 96
 - Date data type 78–79
 - compareTo() method 247
 - equals() method 103
 - implementation 91
 - toString() method 103
 - Decision problem 913
 - Decision tree 280
 - Declaration statement 14
 - Dedup 490
 - Default initialization 18, 86
 - Defensive copy 112
 - Degree of a vertex 519
 - Degrees of separation 553–554
 - Denial-of-service attacks 197
 - Dense graph 520
 - Deprecated method 113
 - Depth-first search 530–534
 - bipartiteness 547
 - connected components 543
 - cycle detection 547
 - directed cycle 574–581
 - longest path 912
 - maze exploration 530
 - path finding 535–537
 - reachability 570–573
 - strong components 584–591
 - topological order 574–581
 - transitive closure 592
 - Tremaux exploration 530
 - 2-colorability 547
 - union-find 546
 - Depth of a node 226
 - Deque data type 167, 212
 - Design by contract 107
 - Deterministic finite state automaton 764
 - Devroye, L. 412
 - DFA. *See* Deterministic finite state automaton
 - Diameter of a graph 559, 685
 - Dictionary 361.
 - See also* Symbol table
 - Digraph. *See* Directed graph
 - Digraph data type 568–569
 - Dijkstra, E. W. 128, 298, 628, 682
 - Dijkstra's 2-stack algorithm 128–131
 - Dijkstra's algorithm 652–657
 - bidirectional search 690
 - negative weights 668
 - Directed acyclic graph 574–583
 - depth-first orders 578
 - edge-weighted 658–667
 - Hamiltonian path 598
 - lowest common ancestor 598
 - shortest ancestral path 598
 - topological order 575
 - topological sort 575
 - Directed cycle 567
 - Directed cycle detection 576
 - Directed edge 566
 - Directed graph 566–603.
 - See also* Edge-weighted digraph
 - acyclic 574–583

adjacency-lists representation 568, 568–569
 all-pairs reachability 590
 anatomy of 567
 breadth-first search 573
 cycle 567
 cycle detection 576
 defined 566
 directed paths 573
 edge 566
 Euler cycle 598
 in-degree and out-degree 566
 Kosaraju's algorithm 586–590
 path 567
 postorder traversal 578
 preorder traversal 578
 reachability 570–572
 reachable vertex 567
 reverse 568
 reverse postorder 578
 shortest ancestral path 598
 shortest directed paths 573
 simple 567
 strong component 584
 strong connectivity 584–591
 strongly-connected 584
 topological order 575–583
 transitive closure 592
 Directed path 567
 Disjoint set union.
 See Union find
 Divide-and-conquer paradigm
 mergesort 270
 quicksort 288, 293
 Division by zero 51
 Documentation 28
 Double hashing 483
 double primitive data type 12
 Double probing 483
 Doubling array.
 See Resizing array
 Doubling ratio experiment 192

Doubling test 176–177
 Doubly-linked list 146
 Draw data type 82, 83
 Dump 813
 Duplicate keys
 3-way quicksort 301
 hash table 488
 in a symbol table 363
 MSD string sort 715
 priority queue 309
 quicksort 292
 sorting 344
 stability 341
 Dutch National Flag 298
 Dynamic connectivity 216
 Dynamic memory allocation 104
 Dynamic programming 671
 Dynamic resizing array.
 See Resizing array

E

Eccentricity of a vertex 559
 Edge
 backward 891
 critical 633, 900
 crossing 606
 data type 608
 directed 566, 638
 eligible 646
 forward 891
 incident 519
 ineligible 616, 646
 parallel 518
 self-loop 518
 undirected 518
 weighted 608, 638
 Edge-connected graph 562
 Edge relaxation 646–647
 Edge-weighted DAG 658–667
 critical path method 663–667
 longest paths 661
 shortest paths 658–660

Edge-weighted digraph
 adjacency-lists 644
 complete 679
 data type 641
 diameter of 685
 shortest paths 638–693
 Edge-weighted graph
 adjacency-lists 609
 data type 608
 min spanning forest 605
 min spanning tree 604–637
 Edmonds, J. 901
 Eligible edge 616, 646
 Ellipsoid algorithm 909
 Empty string epsilon 789, 805
 Encapsulation 96
 Entropy 300–301
 Epsilon-transition 795
 Equal keys. *See* Duplicate keys
 equals() method 102–103
 symbol table 365
 Equivalence class 216
 Equivalence relation
 connectivity 216, 543
 equals() method 102
 strong connectivity 584
 Erdős number 554
 Erdős, P. 554
 Erdős-Renyi model 239
 Error. *See also* Exception
 OutOfMemoryError 107
 StackOverflowError 57, 107
 Euclid's algorithm 4, 58
 Eulerian cycle 562, 598
 Event-driven simulation 349,
 856–865
 Exception. *See also* Error
 Arithmetic 107
 ArrayIndexOutOfBoundsException 107
 ClassCast 387
 NoSuchElement 139
 NullPointerException 159

Runtime 107
 UnsupportedOperationException 139
 ConcurrentModification 160
`exch()` method 245, 315
 Exhaustive search 912
 Exponential inequality 185
 Exponential running time 186, 661, 911
 Extended Church-Turing thesis 910
 Extensible library 101
 External path length 418, 832

F

Factor an integer 919
 Factorial function 185
 Fail-fast design 107
 Fail-fast iterator 160, 171
 Farthest pair 210
 Fibonacci heap 628, 682
 Fibonacci numbers 57
 FIFO. *See* First-in first-out policy
 FIFO queue.
 See Queue data type
 File system 493
 Filter 60
 blacklist 491
 dedup 490
 whitelist 8, 491
 Final access modifier 105–106
 Fingerprint search 774–778
 Finite state automaton.
 See Deterministic finite state automaton
 First-in-first-out policy 126
 Fixed-capacity stack 132, 134–135
 Fixed-length code 826
 Float primitive data type 13
 Flood fill 563
 Floor function
 binary search tree 406

mathematical function 185
 ordered array 380
 symbol table 367, 383
 Flow 888.
 See also Maxflow problem
 flow network 888
 inflow and outflow 888
 residual network 895
 st-flow 888
 st-flow network 888
 value 888
 Floyd, R. W. 326
 Floyd's method 327
 for loop 16
 Ford-Fulkerson 891–893
 analysis of 900
 maximum-capacity path 901
 shortest augmenting path 897
 Ford, L. 683
 Foreach loop 138
 arrays 160
 strings 160
 Forest
 graph 520
 spanning 520
 Forest-of-trees 225
 Formatted output 37
 Fortran language 217
 Fragile base class problem 112
 Frazer, W. 306
 Fredman, M. L. 628
 Function-call stack 246, 415

G

Garbage collection 104, 195
 loitering 137
 mark-and-sweep 573
 Gaussian elimination 919
 Generics 122–123, 134–135
 and covariant arrays 158
 and type erasure 158
 array creation 134, 158

parameterized type 122
 priority queues 309
 stacks and queues 134–135
 symbol tables 363
 type parameter 122, 134
 Genomics 492, 498
 Geometric data types 76–77
 Geometric sum 185
`getClass()` method 101, 103
 Girth of a graph 559
 Global variable 113
 Gosper, R. W. 759
 Graph data type 522–527
 Graph isomorphism 561, 919
 Graph processing 514–693.
 See also Directed graph;
 See also Edge-weighted digraph;
 See also Edge-weighted graph;
 See also Undirected graph;
 See also Directed acyclic graph
 Bellman-Ford 668–681
 breadth-first search 538–541
 components 543–546
 critical-path method 664–666
 depth-first search 530–537
 Dijkstra's algorithm 652
 Kosaraju's algorithm 586–590
 Kruskal's algorithm 624–627
 longest paths 911–912
 max bipartite matching 906
 min spanning tree 604–637
 Prim's algorithm 616–623
 reachability 570–573
 shortest paths 638–693
 strong components 584–591
 symbol graphs 548
 transitive closure 592–593
 union-find 216–241
 Greatest common divisor 4
 Greedy algorithm

Huffman encoding 830
 minimum spanning tree 607
 Grep 804

H

Halting problem 910
 Hamiltonian cycle 562, 920
 Hamiltonian path 598, 913, 920
 Handle 112
 Hard-disc model 856
 Harmonic number 23, 185
 Harmonic sum 185
 hashCode() method 101, 102, 461–462
 Hash function 458, 459–463
 modular 459
 perfect 480
 Rabin-Karp algorithm 774
 Hashing. *See* Hash function;
 See also Hash table
 hash function 459–463
 time-space tradeoff 458
 Hash table 458–485
 array resizing 474–475
 clustering 472
 collision resolution 458
 cuckoo hashing 484
 deletion 468
 double hashing 483
 double probing 483
 duplicate keys 488
 hashCode() method 461–462
 hash function 458
 Java library 489
 linear probing 469–474
 load factor 471
 memory usage of 476
 primitive types 488
 separate chaining 464–468
 uniform hashing assumption 463
 Head vertex 566

Heap. *See* Binary heap
 multiway 319
 Heap order 313
 Heapsort 323–327
 Height
 2-3 search tree 429
 binary search tree 412
 complete binary tree 314
 red-black BST 444
 tree 226
 Hibbard deletion 422
 Hibbard, T. 410
 Hoare, C. A. R. 205
 Horner's method 460
h-sorted array 258
 Huffman compression 350, 826–838
 analysis of 833
 optimality of 833
 Huffman, D. 827

I

if statement 15
 if-else statement 15
 Immutability 105–106
 defensive copy 112
 of strings 114, 202, 696
 priority queue keys 320
 symbol table keys 365
 Implementation 28, 88
 Implementation inheritance 101
 import statement 27, 29, 66
 Incident edge 519
 Increment sequence 258
 In data type 41, 83
 Indegree of a vertex 566
 Index 361, 496–501
 a string 877
 files 500–501
 inverted 498–501
 Index priority queue 320–322
 Dijkstra's algorithm 652

Prim's algorithm 620
 Indirect sort 286
 Ineligible edge
 minimum spanning tree 616
 shortest paths 646
 Infix notation 13, 128, 162
 Inherited methods 66, 100–101
 compareTo() 338–339
 compareTo() 246–247
 equals() 102–103
 getClass() 101
 hashCode() 101, 461–462
 hasNext() 138
 iterator() 138
 next() 138
 toString() 66, 101
 Inner loop 180, 184, 195
 Inorder tree traversal 412
 In-place merge 270
 Input and output 82–83
 binary data 812–815
 from a file 41
 piping 40
 redirection 40
 Input model 197
 Input size 173
 Insertion sort 250–252
 Instance method 65, 84
 Instance variable 84
 int primitive data type 12
 Integer linear inequality satisfi-
 ability problem 913
 Integer linear programming 920
 Integer overflow 51
 Interface 100
 Comparable 246–247
 Comparator 338–340
 Iterable 138
 Iterator 139
 Interface inheritance 100
 Interior point method 909
 Internal path length 412

- Internet DNS 493
 - Internet Movie Database 497
 - Interpreter 130
 - Interval graph 564
 - Intractability 910–921
 - Inversion 252, 286
 - Inverted index 498–501
 - Ising model 920
 - Isomorphic graph 561
 - Item
 - contains a key 244
 - sorting 244
 - symbol table 387
 - with multiple keys 339
 - Item type parameter 134
 - Iteration 123, 138–141
 - fail-fast 171
 - foreach loop 123
- J**
- Jacquet, P. 882
 - Jarnik's algorithm 628.
 - See also* Prim's algorithm
 - Jarnik, V. 628
 - Java programming
 - array 18–21
 - arrays as objects 72
 - arrays of objects 72
 - assertion 107
 - assert statement 107
 - assignment statement 14
 - autoboxing 122
 - autounboxing 122
 - base class 101
 - bitwise operators 52
 - block statement 15
 - boolean expression 13
 - break statement 15
 - bytecode 10
 - cast 13
 - class 10, 64
 - classpath 66
 - comparison operator 13
 - conditional statement 15
 - constructor 65, 84
 - continue statement 15
 - covariant arrays 158
 - create an object 67
 - declaration statement 14
 - default initialization 18, 86
 - deprecated method 113
 - derived class 101
 - Error 107
 - Exception 107
 - expression 11, 13
 - final modifier 84, 105–106
 - for loop 16
 - foreach loop 123
 - garbage collection 104
 - generic array creation 158
 - generics 122–123, 134–135
 - identifier 11
 - if statement 15
 - if-else statement 15
 - implicit assignment 16
 - import statement 29
 - imported system libraries 27
 - infix expression 13
 - inheritance 100–101
 - inherited method 66
 - initializing declarations 16
 - inner class 159
 - instance method 65, 84, 86
 - instance method signature 86
 - instance variable 84
 - invoke instance method 68
 - iterable collections 123
 - just-in-time compiler 195
 - literal 11
 - loitering 137
 - loop statement 15
 - memory management 104
 - modular programming 26
 - nested class 159
 - new() 67
 - objects 67–74
 - objects as arguments 71
 - objects as return values 71
 - operator 11
 - operator precedence 13
 - orphan 137
 - orphaned object 104
 - overloading 12, 24
 - override a method 101
 - parameterized type 122, 134
 - pass by reference 71
 - pass by value 24, 71
 - primitive data type 11–12
 - private class 159
 - private modifier 84
 - protected modifier 110
 - public modifier 84, 110
 - ragged array 19
 - recursion 25
 - reference 67
 - reference type 64
 - return statement 86
 - scope 14, 87
 - short-circuit operator 52
 - side effects 24
 - single-statement blocks 16
 - standard libraries 27
 - standard system libraries 27
 - statement 14
 - static method 22–25
 - static variable 113
 - strong typing 14
 - subclass 101
 - superclass 101
 - this reference 87
 - throw an error/exception 107
 - two-dimensional array 19
 - type conversion 13, 35
 - type erasure 158
 - type parameter 122
 - unit testing 26

- using objects 69
 - variable 11
 - visibility modifier 84
 - while loop 15
 - wrapper type 122
 - Java system sort 306
 - Java virtual machine 51
 - java.awt
 - Color 75
 - Font 75
 - java.io
 - File 75
 - java.lang
 - ArithmeticException 107
 - ArrayIndexOutOfBoundsException 107
 - Boolean 102
 - Byte 102
 - Character 102
 - ClassCastException 387
 - Comparable 100
 - Double 34, 102
 - Float 102
 - Integer 102
 - Iterable 100, 123, 138, 154
 - Long 102
 - Math 28
 - NullPointerException 107, 113, 159
 - Object 101
 - OutOfMemoryError 107
 - RuntimeException 107
 - Short 102
 - StackOverflowError 57, 107
 - StringBuilder 27, 105, 697
 - UnsupportedOperationException 139
 - java.net
 - URL 75
 - java.util
 - ArrayList 160
 - Arrays 29
 - Comparator 100, 339
 - ConcurrentModification 160
 - Date 113
 - HashMap 489
 - Iterator 100, 138–141, 154
 - LinkedList 160
 - NoSuchElementException 139
 - PriorityQueue 352
 - Stack 159
 - TreeMap 489
 - Job-scheduling problem.
 - See Scheduling
 - Josephus problem 168
 - Just-in-time compiler 195
- K**
- Karp, R. 901
 - Karp, R. M. 759
 - Kendall tau distance 286, 345, 356
 - Kevin Bacon number 553–554
 - Key 244
 - Key equality
 - ordered symbol table 368
 - symbol table 365
 - Key-indexed counting 703–705
 - Key type parameter
 - priority queue 309
 - symbol table 361
 - Keyword in context 879
 - Khachian, L. G. 909
 - Kleene’s theorem 794
 - Knuth, D. E. 178, 205, 759
 - Knuth-Morris-Pratt 762–769
 - Knuth shuffle 32
 - Kosaraju’s algorithm 586–590
 - Kruskal, J. 628
 - Kruskal’s algorithm 624–627
 - KWIC. See Keyword-in-context
- L**
- Last-in-first-out policy 127
 - Las Vegas algorithm 778
 - Leading-term approximation.
 - See Tilde notation
 - Least-significant digit.
 - See LSD string sort
 - Leipzig Corpora Collection 371
 - Lempel, A. 839
 - less() method 245, 315
 - Level-order traversal
 - binary heap 313
 - binary search tree 420
 - Levin, L. 918
 - LIFO. See Last-in first-out policy
 - LIFO stack. See Stack data type
 - Linear equation satisfiability 913
 - Linear inequality satisfiability 913
 - Linear probing 469–474
 - Linear programming 907–909
 - ellipsoid algorithm 909
 - interior point method 909
 - reductions 907–909
 - simplex algorithm 909
 - Linear running time 186
 - Linearithmic running time 186
 - Linked allocation 156
 - Linked list 142–146
 - building 143
 - circular 165
 - defined 142
 - deletion 145
 - deletion from beginning 145
 - garbage collection 145
 - insertion 145
 - insertion at beginning 144
 - insertion at end 145
 - iterator 154–155
 - memory usage of 201
 - Node data type 142
 - queue 150
 - reverse a 165
 - sequential search 374
 - shuffle a 286
 - sort a 286

- stack 147–149
- traversal 146
- Literal
 - nu11 112–113
 - primitive type 11
 - string 80
- Load-balancing 349, 909
- Load factor 471
- Local minimum 210
- Logarithm function
 - binary 185
 - integer binary 185
 - natural 185
- Logarithmic running time 186
- Log-log plot 176
- Loitering 137
- Longest common prefix 875
- Longest paths 661, 911
- Longest prefix match 842
- Longest-processing-time first
 - rule 349
- Longest repeated substring 875
- long primitive data type 13
- Loop
 - for 16
 - foreach 138
 - inner 180
 - while 15
- Lossless data compression 811
- Lossy data compression 811
- Lower bound
 - priority queue 332
 - sorting 279–282
 - 3-sum problem 190
 - union-find 231
- Lowest common ancestor 598
- Loyd, S. 358
- LSD string sort 706–709
- LZW algorithm 839–845
 - compression 840
 - expansion 841
 - trie representation 840
- ## M
- Manber, U. 884
- Mark-and-sweep garbage collection 573
- Maslow, A. 904
- Maslow’s hammer 904
- Matrix data type 60
- Maxflow-mincut theorem 894
- Maxflow problem 886–902.
 - See also* Mincut problem
 - Ford-Fulkerson 891–893
 - integrality property 894
 - maxflow-mincut theorem 892–894
 - max bipartite matching 906
 - preflow-push algorithm 902
 - reductions 905–907
 - residual network 895–897
- Maximum
 - in array 30
 - in binary heap 313
 - in binary search tree 406
 - in ordered symbol table 367
- Maximum *st*-flow problem.
 - See* Maxflow problem
- Max bipartite matching 906
- Maze 530
- McIlroy, D. 298, 306
- McKellar, A. 306
- Median 332, 345–347
- Median-of-3 partitioning 305
- Memory management 104
 - linked allocation 156
 - loitering 137
 - orphan 137
 - Sequential allocation 156
- Memory usage 200–204
 - array 202
 - hash table 476
 - linked list 201
 - nested class 201
 - object 67, 201
 - primitive types 200
 - R-way trie 744
 - stack 213
 - string 202
 - substring 202–204
- Mergesort 270–288
 - abstract in-place merge 270
 - analysis of 272
 - bottom-up 277
 - linked list 279, 286
 - multiway 287
 - natural 285
 - optimality 282
 - stability 341
 - top-down 272
- Merging 270–271
- Method
 - inherited 100–101
 - instance 68–69, 86–87
 - static 22–25
- Mincut problem 893. *See also* Maxflow problem
- Minimum
 - in array 30
 - in binary search tree 406
 - in ordered symbol table 367
- Min spanning forest 605
- Min spanning tree 604–637
 - Boruvka’s algorithm 636
 - bottleneck shortest paths 690
 - critical edge 633
 - crossing edge 606
 - cut 606
 - cut optimality conditions 634
 - cut property 606
 - defined 604
 - greedy algorithm 607
 - Kruskal’s algorithm 624–627
 - Prim’s algorithm 616–623
 - reverse-delete algorithm 633
 - Vysotsky’s algorithm 633
- Minimum *st*-cut problem.

See Mincut problem
 Minotaur 530
 Mismatched character rule 770
 M. L. Fredman 628
 Modular hash function 459, 774
 Modular programming 26
 Monte Carlo algorithm 776
 Moore, J. S. 759
 Moore's law 194–195
 Morris, J. H. 759
 Most-significant-digit sort.
 See MSD string sort
 Move-to-front 169
 MSD string sort 710–718
 Multidimensional sort 356
 Multigraph 518
 Multiple-source reachability
 problem 570, 797
 Multiset 509
 Multiway mergesort 287
 Multiway trie. *See* R-way trie
 Myers, E. 884

N

Natural logarithm function 185
 Natural mergesort 285
 Natural order 337
 Negative cost cycle.
 See Negative cycle
 Negative cycle 668–670,
 677–681
 Nested class 159
 Network flow.
 See Maxflow problem
 new() 67
 Newton's method 23
 NFA. *See* Nondeterministic
 finite-state automata
 Node data type 159
 bag 155
 binary search tree 398
 Huffman trie 828

linked list 142
 queue 151
 red-black BST 433
 R-way trie 734
 stack 149
 ternary search trie 747
 Nondeterminism 794
 Turing machine 914
 Nondeterministic finite-state
 automata 794–799

NP 912

NP-complete 917–918

Null link 396

null literal 112–113

O

Object 67–74. *See also* Object-
 oriented programming
 behavior 67, 73
 identity 67, 73
 memory usage of 201
 state 67, 73
 Object-oriented program-
 ming 64–119
 arrays of objects 72
 creating an object 67
 declaring an object 67
 encapsulation 96
 inheritance 100
 instance 73
 instantiate an object 67
 invoke instance method 68
 objects 67–74
 objects as arguments 71
 objects as return values 71
 reference 67
 subtyping 100
 using objects 69
 Odd-length cycle in a graph 562
 OOP. *See* Object-oriented pro-
 gramming
 Operations research 349

Optimization problem 913
 Ordered symbol table 366–369
 floor and ceiling 367
 minimum and maximum 367
 ordered array 378
 range query 368
 rank and selection 367
 red-black BST 446
 Order of growth 179
 Order-of-growth classifica-
 tions 186–188
 Order-of-growth hypothesis 180
 Order statistic 345
 binary search tree 406
 ordered symbol table 367
 quickselect 345–347
 Orphaned object 104, 137
 Out data type 41, 83
 Outdegree of a vertex 566
 Output. *See* Input and output
 Overflow 51
 Overloading
 constructor 84
 static method 24
 Overriding a method 66, 101

P

P complexity class 914
P=NP question 916
 Page data type 870
 Palindrome 81, 783
 Parallel arrays
 linear probing 471
 ordered symbol table 378
 sorting 357
 Parallel edge 518, 566, 612, 640
 Parallel job scheduling 663–667
 Parallel precedence-constrained
 scheduling 663, 904
 Parameterized type. *See* Generics
 Parent-link representation
 breadth-first search tree 539

- depth-first search tree 535
- minimum spanning tree 620
- shortest-paths tree 640
- union-find 225
- Parsing
 - an arithmetic expression 128
 - a regular expression 800–804
- Particle data type 860
- Partitioning algorithm 290
 - 2-way 288
 - 3-way (Bentley-McIlroy) 306
 - 3-way (Dijkstra) 298
 - median-of-3 296, 305
 - median-of-5 305
 - selection 346–347
- Partitioning item 290
- Pass by reference 71
- Pass by value 24, 71
- Path. *See* Longest paths;
See also Shortest paths
 - augmenting 891
 - Hamiltonian 913, 920
 - in a digraph 567
 - in a graph 519
 - length of 519, 567
 - simple 519, 567
- Path compression 231
- Pattern matching.
See Regular expression
- Perfect hash function 480
- Performance. *See* Propositions
- Permutation
 - Kendall-tau distance 356
 - random 168
 - ranking 345
 - sorting 354
- Phone book 492
- Picture data type 814
- Piping 40
- Point data type 77
- Pointer 111. *See also* Reference
 - safe 112
- Pointer sort 338
- Poisson approximation 466
- Poisson distribution 466
- Polar angle 356
- Polar coordinate 77
- Polar sort 356
- Poly-time reduction 916
- Pop operation 127
- Postfix notation 162
- Postorder traversal
 - of a digraph 578
 - reverse 578
- Power law 178
- Pratt, V. R. 759
- Precedence-constrained scheduling 574–575
- Precedence order
 - arithmetic expressions 13
 - regular expressions 789
- Prefix-free code 826–827
 - compression 829
 - expansion 828
 - Huffman 833
 - optimal 833
 - reading and writing 834–835
 - trie representation 827
- Preorder traversal
 - of a digraph 578
 - of a trie 834
- Prime number 23, 774, 785
- Primitive data type 11–12
 - memory usage of 200
 - reason for 51
 - wrapper type 102
- Primitive type
 - versus reference type 110
- Prim, R. 628
- Prim's algorithm 350, 616–623
 - eager 620–623
 - lazy 616–619
- Priority queue 308–335
 - binary heap 313–322
 - change priority 321
 - delete 321
 - Dijkstra's algorithm 652
 - Fibonacci heap 628
 - Huffman compression 830
 - index priority queue 320–321
 - linked-list 312
 - multiway heap 319
 - ordered array 312
 - Prim's algorithm 616
 - reductions 345
 - remove the minimum 321
 - soft heap 629
 - stability 356
 - unordered array 310
- private access modifier 84
- Probabilistic algorithm. *See* Randomized algorithm
- Probe 471
- Problem size 173
- Programs
 - Accumulator 93
 - AcyclicLP 661
 - AcyclicSP 660
 - Arbitrage 680
 - Average 39
 - Bag 155
 - BellmanFordSP 674
 - BinaryDump 814
 - BinarySearch 47
 - BinarySearchST 379, 381, 382
 - BlackFilter 491
 - BoyerMoore 772
 - BreadthFirstPaths 540
 - BST 398, 399, 407, 409, 411
 - BTreeSET 872
 - Cat 82
 - CC 544
 - CollisionSystem 863–864
 - Count 699
 - Counter 89
 - CPM 665

- Cycle 547
- Date 91, 103, 247
- DeDup 490
- DegreesOfSeparation 555
- DepthFirstOrder 580
- DepthFirstPaths 536
- DepthFirstSearch 531
- Digraph 569
- DijkstraAllPairsSP 656
- DijkstraSP 655
- DirectedCycle 577
- DirectedDFS 571
- DirectedEdge 642
- DoublingTest 177
- Edge 610
- EdgeWeightedDigraph 643
- EdgeWeightedGraph 611
- Evaluate 129
- Event 861
- Example 245
- FileIndex 501
- FixedCapacityStack 135
- FixedCapacityStackOf-
Strings 133
- Flips 70
- FlipsMax 71
- FlowEdge 896
- FordFulkerson 898
- FrequencyCounter 372
- Genome 819–820
- Graph 526
- GREP 804
- Heap 324
- HexDump 814
- Huffman 836
- Insertion 251
- KMP 768
- KosarajuSCC 587
- KruskalMST 627
- KWIC 881
- LazyPrimMST 619
- LinearProbingHashST 470
- LookupCSV 495
- LookupIndex 499
- LRS 880
- LSD 707
- LZW 842, 844
- MaxPQ 318
- Merge 271, 273
- MergeBU 278
- MSD 712
- Multiway 322
- NFA 799, 802
- PictureDump 814
- PrimMST 622
- Queue 151
- Quick 289, 291
- Quick3string 720
- Quick3way 299
- RabinKarp 777
- RedBlackBST 439
- ResizingArrayQueue 140
- ResizingArrayStack 141
- Reverse 127
- RLE 824
- Rolls 72
- Selection 249
- SeparateChainingHashST 465
- SequentialSearchST 375
- SET 489
- Shell 259
- SortCompare 256
- SparseVector 503
- Stack 149
- StaticSETofInts 99
- Stats 125
- Stopwatch 175
- SuffixArray 883
- SymbolGraph 552
- ThreeSum 173
- ThreeSumFast 190
- TopM 311
- Topological 581
- Transaction 340
- TransitiveClosure 593
- TrieST 737–741
- TST 747
- TwoColor 547
- TwoSumFast 189
- UF 221
- VisualAccumulator 95
- WeightedQuickUnionUF 228
- WhiteFilter 491
- Whitelist 99
- Properties 180
 - 3-sum 180
 - Boyer-Moore algorithm 773
 - insertion sort 255
 - quicksort 343
 - Rabin-Karp algorithm 778
 - red-black BST 445
 - selection sort 255
 - separate-chaining 467
 - shellsort 262
 - versus proposition 183
- Propositions 182
 - 2-3 search tree 429
 - 3-sum 182
 - 3-way quicksort 301
 - 3-way string quicksort 723
- arbitrage 681
- B-tree 871
- Bellman-Ford 671, 673
- binary heap 319
- binary search 383
- BST 403–404, 412
- breadth-first search 541
- brute substring search 761
- complete binary tree 314
- connected components 546
- Cook-Levin theorem 918
- critical path method 666
- cut property 606
- DFS 531, 537, 570
- Dijkstra's algorithm 652, 654
- flow conservation 893
- Ford-Fulkerson 900–901
- generic shortest-paths 651

greedy MST algorithm 607
 heapsort 323, 326
 Huffman algorithm 833
 index priority queue 321
 insertion sort 250, 252
 integer programming 917
 key-indexed counting 705
 Knuth-Morris-Pratt 769
 Kosaraju's algorithm 588, 590
 Kruskal's algorithm 624, 625
 linear-probing hash table 475
 linear programming 908
 longest paths in DAG 661
 longest repeated substring 885
 LSD string sort 706, 709
 maxflow-minicut theorem 894
 maxflow reductions 906
 mergesort 272, 279, 282
 MSD string sort 717, 718
 negative cycles 669
 parallel job scheduling with
 relative deadlines 667
 particle collision 865
 Prim's algorithm 616, 618, 623
 quick-find algorithm 223
 quickselect 347
 quicksort 293–295
 quick-union algorithm 226
 red-black BST 444, 447
 regular expression 799, 804
 resizing-array stack 199
 R-way trie 742, 743, 744
 selection sort 248
 separate-chaining 466, 475
 sequential search 376
 shortest paths in DAG 658
 shortest-paths optimality 650
 shortest paths reductions 905
 sorting lower bound 280, 300
 sorting reductions 903
 suffix array 882
 ternary search trie 749, 751

topological order 578, 582
 universal compression 816
 weighted quick-union 229
 protected modifier 110
 Protein folding 920
 public access modifier 110
 Pushdown stack 127.
 See also Stack data type
 Push operation 127

Q

Quadratic running time 186
 Quantum computer 911
 Queue data type
 analysis of 198
 API 126
 circular linked list 165
 linked-list 150–151
 resizing-array 140
 Quick-find algorithm 222–223
 Quickselect 345–347
 Quicksort 288–307
 2-way partitioning 290
 3-way partitioning 298–301
 3-way string 719
 analysis of 293–295
 and binary search trees 403
 duplicate keys 292
 function-call stack size 304
 median-of-2 296, 305
 median-of-5 305
 nonrecursive 306
 random shuffle 292
 Quick-union 224–227
 path compression 231
 weighted 227–230

R

Rabin-Karp algorithm 774–778
 Rabin, M. O. 759
 Radius of a graph 559

Radix 700
 Radix sorting. *See* String sorting
 Random bag data type 167
 Randomized algorithm 198
 Las Vegas 778
 Monte Carlo 776
 quickselect 345–347
 quicksort 290, 307
 Rabin-Karp algorithm 776
 3-way string quicksort 722
 Random number 30–32
 Random queue data type 168
 Random string model 716–717
 Range query
 binary search tree 412
 ordered symbol table 368
 Rank
 binary search 25, 378–381
 binary search tree 408, 415
 ordered symbol table 367
 suffix array 879
 Reachability 570–572, 590
 Reachable vertex 567
 Recurrence relation
 binary search 383
 mergesort 272
 quicksort 293
 Recursion 25.
 See also Base case;
 See also Recursion
 binary search 25, 380
 binary search tree 401
 depth-first search 531
 Euclid's algorithm 4
 Fibonacci numbers 57
 mergesort 272
 quicksort 289
 Red-black BST 432–447
 and 2-3 search tree 432
 analysis of 444–447
 color flip 436
 color representation 433

- defined 432
 - delete the maximum 454
 - delete the minimum 453
 - deletion 441–443, 455
 - implementation 439
 - insertion 437–439
 - left-leaning 432
 - perfect black balance 432
 - rotation 433–434
 - search 432
 - Redirection 40
 - Reduction 903–909
 - defined 903
 - polynomial-time 916
 - linear programming 907–909
 - maxflow 905–907
 - priority queue 345
 - shortest-paths 904–905
 - sorting 344–347, 903–904
 - Reference 67
 - Reference type 64
 - Reflexive relation 102, 216, 247, 584
 - Regular expression 82, 788
 - building an NFA 800–804
 - closure operation 789
 - concatenation operation 789
 - defined 790
 - epsilon-transition 795
 - match transition 795
 - nondeterministic finite-state automaton 794–799
 - or operation 789
 - parentheses 789
 - $\backslash\text{s}+$ 82
 - shortcuts 791
 - simulating an NFA 797–799
 - Rehashing 474
 - Relation
 - antisymmetric 247
 - equivalence 102, 216, 584
 - reflexive 102, 216, 247, 584
 - symmetric 102, 216, 584
 - total order 247
 - transitive 102, 216, 247, 584
 - Residual network 895–897
 - Resizing array 136–137
 - binary heap 320
 - hash table 474–475
 - queue 140
 - stack 136
 - Return value 22
 - Reverse postorder traversal 578
 - Reverse
 - a linked list 165–166
 - an array 21
 - array iterator 139
 - with a stack 127
 - Reverse-delete algorithm 633
 - Reverse graph 586
 - Reverse Polish notation. *See* Postfix notation
 - Reverse postorder 578
 - Ring buffer data type 169
 - RLE. *See* Run-length encoding
 - Robson, J. 412
 - Rooted tree 640
 - Rotation in a BST 433–434, 452
 - Run-length encoding 822–825
 - Running time 172–173
 - analysis of 176
 - constant 186
 - cubic 186
 - doubling ratio 192
 - exponential 186
 - inner loop 180
 - linear 186
 - logarithmic 186
 - measuring 174
 - order of growth 179
 - quadratic 186
 - tilde approximation 178–179
 - Run-time error. *See* Error; *See also* Exception
 - R-way trie 730–744
 - Alphabet 741
 - analysis of 742–743
 - collecting keys 738
 - deletion 740
 - insertion 734
 - longest prefix 739
 - memory usage of 744
 - one-way branching 744–745,
 - representation 734
 - search 732–733
 - wildcard match 739
- ## S
- Safe pointer 112
 - Sample mean 30
 - Samplesort 306
 - Sample standard deviation 30
 - Sample variance 30
 - Scheduling
 - critical-path method 664–666
 - load-balancing problem 349
 - LPT first 349
 - parallel precedence-constrained 663–667
 - precedence constraint 574–575
 - relative deadlines 666
 - SPT first 349
 - Scientific method 172
 - Scope of a variable 14, 87
 - Search hit 376
 - Searching 360–513. *See also* Symbol table
 - Search miss 376
 - Search problem 912
 - Sedgewick, R. 298
 - Selection 345
 - binary search tree 406
 - ordered symbol table 367
 - quickselect 346–347
 - suffix array 879

- Selection client 249
- Selection sort 248–249
- Self-loop 518, 566, 612, 640
- Separate-chaining 464–468
- Sequential allocation 156
- Sequential search 374–377
- Set data type 489–491
- Shannon entropy 300–301
- Shellsort 258–262
- Shortest ancestral path 598
- Shortest augmenting path 897
- Shortest path 638
- Shortest paths problem 638–693
 - all-pairs 656
 - arbitrage detection 679–681
 - Bellman-Ford 668–678
 - bitonic 689
 - bottleneck 690
 - certification 651
 - critical edge 690
 - Dijkstra’s algorithm 652–657
 - edge relaxation 646–647
 - edge-weighted DAG 658–667
 - generic algorithm 651
 - ineligible edge 646
 - in Euclidean graphs 656
 - monotonic 689
 - negative cycle 669
 - Negative cycle detection 670
 - negative weights 668–681
 - optimality conditions 650
 - parent-link 640
 - reduction 904–905
 - shortest-paths tree 640
 - single-source 639, 654
 - source-sink 656
 - undirected graph 654
 - vertex relaxation 648
- Shortest-processing-time-first rule 349, 355
- short primitive data type 13
- Shuffling
 - a linked list 286
 - an array 32
 - quicksort 292
- Side effect 22, 108
- Signature
 - instance method 86
 - static method 22
- Simple digraph 567
- Simple graph 518
- Simplex algorithm 909
- Single-source problems
 - connectivity 556
 - directed paths 573
 - longest paths in DAG 661
 - paths 534
 - reachability 570
 - shortest directed paths 573
 - shortest paths in undirected graphs 654, 904
 - shortest paths 538, 639
- Social network 517
- Soft heap 629
- Software cache 391, 451, 462
- Sollin, M. 628
- Sorting 242–359.
 - See also* String sorting
 - 3-way quicksort 298–301
 - binary search tree 412
 - certification 246, 265
 - Comparable 246–247
 - compare-based 279
 - complexity of 279–282
 - cost model 246
 - entropy-optimal 296–301
 - extra memory 246
 - heapsort 323–327
 - indirect 286
 - in-place 246
 - insertion sort 250–252
 - inversion 252
 - lower bound 279–282, 306
 - mergesort 270–288
 - partially-sorted array 252
 - pointer 338
 - primitive types 343
 - quicksort 288–307
 - reduction 903–904
 - reductions 344–347
 - selection sort 248–250
 - shellsort 258–262
 - stability 341
 - suffix array 875–885
 - system sort 343
- Source-sink shortest paths 656
- Spanning forest 520
- Spanning tree 520, 604
- Sparse graph 520
- Sparse matrix 510
- Sparse vector 502–505
- Specification problem 97
- SPT. *See* Shortest paths tree;
 - See also* Shortest-processing-time-first rule
- st-cut 892
- st-flow 888
- st-flow network 888
- Stability 341, 355
 - insertion sort 341
 - key-indexed counting 705
 - LSD string sort 706
 - mergesort 341
 - priority queue 356
- Stack data type 127
 - analysis of 198, 199
 - array implementation 132
 - fixed-capacity 132–133
 - generic 134
 - iteration 138–140
 - linked-list 147–149
 - resizing array 136
- Standard deviation 30
- Standard drawing 36, 42–45
- Standard input 36, 39
- Standard libraries 30

- Draw 82–83
- In 41, 82–83
- Out 41, 82–83
- StdDraw 43
- StdIn 39
- StdOut 37
- StdRandom 30
- StdStats 30
- Stopwatch 174–175
- Standard output 36, 37–38
- Static method 22–25
 - argument 22
 - defining a 22
 - invoking a 22
 - overloaded 24
 - pass by value 24
 - recursive 25
 - return statement 24
 - return value 22
 - side effect 22, 24
 - signature 22
- Static variable 113
- Statistics
 - chi-square 483
 - median 345
 - minimum and maximum 30
 - order 345
 - sample mean 30, 125
 - sample standard deviation 30
 - sample variance 30, 125
- StdDraw library 43
- StdIn library 39
- StdOut library 37
- StdRandom library 30
- StdStats library 30
- Steque data type 167, 212
- Stirling's approximation 185
- Stopwatch data type 174–175
- String data type 34, 80–81
 - API 80
 - characters 696
 - charAt() method 696
 - concatenation 34, 697
 - conversion 102
 - immutability 696
 - indexing 696
 - indexOf() method 779
 - length 696
 - length() method 696
 - literal 34
 - memory usage of 202
 - + operator 80, 697
 - substring extraction 696
 - substring() method 696
- String processing 80–81, 694–851
 - data compression 810–851
 - regular expression 788
 - sorting 702–729
 - substring search 758–785
 - suffix array 875–885
 - tries 730–757
- String search. *See* Substring search; *See also* Trie
- String sorting 702–729
 - 3-way quicksort 719–723
 - key-indexed counting 703
 - LSD string sort 706–709
 - MSD string sort 710–718
- Strong component 584
- Strong connectivity 584–591
- Strongly connected component. *See* Strong component
- Strongly connected relation 584
- Strongly typed language 14
- Subclass 101
- Subgraph 519
- Sublinear running time 716, 779
- Substring extraction
 - memory usage of 202–204
 - substring() method 696
- Substring search 758–785
 - Boyer-Moore 770–773
 - brute-force 760–761
 - indexOf() method 779
 - Knuth-Morris-Pratt 762–769
 - Rabin-Karp 774–778
- Subtyping 100
- Suffix array 875–885
- Suffix array data type 879
- Suffix-free code 847
- Superclass 101
- Symbol digraph 581
- Symbol graph 548–555
- Symbol table 360–513
 - 2-3 search tree 424–431
 - API 363, 366
 - associative array 363
 - balanced search tree 424–457
 - binary search 378–384
 - binary search tree 396–423
 - B-tree 866–874
 - cost model 369
 - defined 362
 - duplicate key policy 363
 - floor and ceiling 367
 - hash table 458–485
 - insertion 362
 - key equality 365
 - lazy deletion 364
 - linear-probing 469–474
 - minimum and maximum 367
 - null value 364
 - ordered 366–369
 - ordered array 378
 - range query 368
 - rank and selection 367
 - red-black BST 432–447
 - R-way trie 732–745
 - search 362
 - separate-chaining 464–468
 - sequential search 374
 - string keys 730–757
 - ternary search trie 746–751
 - trie 730–757
 - unordered linked list 374
- Symmetric order 396

Symmetric relation 102, 216,
584

Szpankowski, W. 882

T

Tail vertex 566

Tale of Two Cities 371

Tandem repeat 784

Tarjan, R. E. 590, 628

Terminal window 10, 36

Ternary search trie 746–751

alphabet 750

analysis of 749

collecting keys 750

deletion 750

insertion 746

one-way branching 751, 755

prefix match 750

search 746

wildcard match 750

Theseus 530

this reference 87

Threading 420

Tilde notation 178, 206

Time-driven simulation 856

Timing a program 174–175

Top-down 2-3-4 tree 441

Top-down mergesort 272

Topological sort 574–583

depth-first search 578

queue-based algorithm 599

toString() method 66, 102

Total order 247

Transaction data type 78–79

compare() 340

compareTo() 266, 337

hashCode() 462

Transitive closure 592

Transitive relation 102, 216,
247, 584

Transpose a matrix 56

Tree.

2-3 search tree. *See* 2-3 search
tree

binary. *See* Binary tree

binary search tree. *See* Binary
search tree

balanced search tree. *See* Bal-
anced search tree

binomial 237

depth of a node 226

height of 226

inorder traversal 412

min spanning tree. *See* Mini-
mum spanning tree

parent-link 535, 539

preorder traversal 834

rooted 640

size 226

spanning tree. *See* Spanning
tree

undirected graph 520

union-find 224–226

Tremaux exploration 530

Triangular sum 185

Trie 730–757. *See also* R-way
trie; *See also* Ternary
search trie

collecting keys 731

Lempel-Ziv-Welch 840

longest prefix match 731, 842

one-way branching 744–745,
751, 755

prefix-free code 827

preorder traversal 834

reading and writing 834–835

wildcard match 731

Tufte plot 456

Tukey ninther 306

Turing, A. 910

Turing machine 910

Church-Turing thesis 910

computability 910

nondeterministic 914

universality 910

Type conversion 13

Type erasure 158

Type parameter 122, 134

U

Undecidability 97, 817

Undirected graph

acyclic 520

adjacency-lists 524

adjacency-matrix 524

adjacency-sets 527

adjacent vertex 519

articulation point 562

biconnected 562

bipartite 521, 546–547, 562

breadth-first search 538–542

bridge 562

center 559

connected 519

connected component 519

connected to relation 519

connectivity 534, 543–546

cycle 519

cycle detection 546–547

defined 518

degree 519

dense 520

depth-first search 530–533

diameter 559

edge 518

edge-connected 562

edge-weighted.

See Edge-weighted graph

Euler tour 562

forest 520

girth 559

Hamilton tour 562

interval graph 564

isomorphism 561

multigraph 518

- odd cycle detection 562
 - parallel edge 518
 - path 519
 - radius 559
 - self-loop 518
 - simple 518
 - simple cycle 519, 567
 - simple path 519
 - single-source connectivity 556
 - single-source paths 534
 - single-source shortest paths 538
 - spanning forest 520
 - spanning tree 520
 - sparse 520
 - subgraph 519
 - tree 520
 - two-colorability 546–547, 562
 - vertex 518
 - weighted.
 - See Edge-weighted graph
 - Unicode 696
 - Uniform hashing 463
 - Union-find 216–241
 - and depth-first search 546
 - binomial tree 237
 - Boruvka's algorithm 636
 - dynamic connectivity 216
 - forest-of-trees 225
 - Kruskal's algorithm 625
 - parent-link 225
 - path compression 231, 237
 - quick-find 222–223
 - quick-union 224–227
 - weighted quick-find 236
 - weighted quick-union 227–231
 - weighted quick-union by height 237
 - weighted quick-union with path compression 237
 - Uniquely decodable code 826
 - Unit testing 26
 - Universal data compression 816
 - Universality 910
 - Upper bound 206, 207, 281
- V**
- Value type parameter
 - symbol table 361
 - trie 730
 - Variable 10
 - Variable-length code 826
 - Variance 30
 - Vector data type 106
 - Vertex
 - adjacent 519
 - connected to relation 519
 - degree of 519
 - eccentricity 559
 - head and tail 566
 - indegree and outdegree 566
 - reachable 567
 - source 528
 - Vertex cover problem 920
 - Vertex relaxation 648
 - Virtual terminal 10
 - Vyssotsky's algorithm 633
- W**
- Web search 496
 - Weighted digraph. *See* Edge-weighted digraph
 - Weighted edge 604, 638
 - Weighted external path length 832
 - Weighted graph. *See* Edge-weighted graph
 - Weighted quick-union 227–231
 - Weighted quick-union with path compression 237
 - Weiner, P. 884
 - Welch, T. 839
 - while loop 15
 - Whitelist filter 8, 48–49, 99, 491
 - Wide interface 160, 557
 - Wildcard character 791
 - Wildcard match 750
 - Worst-case guarantee 197
 - Wrapper type 102, 122
- Z**
- Zev, J. 839
 - Zero-based indexing 53
 - Zipf's law 393

This page intentionally left blank

ALGORITHMS

Fundamentals

- 1.1 *Pushdown stack (resizing array)*
- 1.2 *Pushdown stack (linked-list)*
- 1.3 *FIFO queue*
- 1.4 *Bag*
- 1.5 *Union-find*

Sorting

- 2.1 *Selection sort*
- 2.2 *Insertion sort*
- 2.3 *Shellsort*
- 2.4 *Top-down mergesort*
- Bottom-up mergesort*
- 2.5 *Quicksort*
- Quicksort with 3-way partitioning*
- 2.6 *Heap priority queue*
- 2.7 *Heapsort*

Symbol Tables

- 3.1 *Sequential search*
- 3.2 *Binary search*
- 3.3 *Binary tree search*
- 3.4 *Red-black BST search*
- 3.5 *Hashing with separate chaining*
- 3.6 *Hashing with linear probing*

Graphs

- 4.1 *Depth-first search*
- 4.2 *Breadth-first search*
- 4.3 *Connected components*
- 4.4 *Reachability*
- 4.5 *Topological sort*
- 4.6 *Strong componenets (Kosaraju)*
- 4.7 *Minimum spanning tree (Prim)*
- 4.8 *Minimum spanning tree (Kruskal)*
- 4.9 *Shortest paths (Dijkstra)*
- 4.10 *Shortest paths in DAGs*
- 4.11 *Shortest paths (Bellman-Ford)*

Strings

- 5.1 *LSD string sort*
- 5.2 *MSD string sort*
- 5.3 *Three-way string quicksort*
- 5.4 *Trie symbol table*
- 5.5 *TST symbol table*
- 5.6 *Substring search (Knuth-Morris-Pratt)*
- 5.7 *Substring search (Boyer-Moore)*
- 5.8 *Substring search (Rabin-Karp)*
- 5.9 *Regular expression pattern matching*
- 5.10 *Huffman compression/expansion*
- 5.11 *LZW compression/expansion*

CLIENTS

Fundamentals

Whitelisting
Expression evaluation
Connectivity

Sorting

Comparing two algorithms
Top M
Multiway merge

Symbol Tables

Dedup
Frequency count
Dictionary lookup
Index lookup
File indexing
Sparse vector with dot product

Graphs

Symbol graph data type
Degrees of separation
PERT
Arbitrage

Strings

Regular expression pattern matching
Huffman compression
Lempel-Ziv-Welch compression

Context

Colliding particle simulation
B-tree set
Suffix array (elementary)
Longest repeated substring
Keyword in context
Maxflow (Ford-Fulkerson)

This page intentionally left blank